

ANSI/AISC 360-10
An American National Standard

Specification for Structural Steel Buildings

June 22, 2010

Supersedes the
Specification for Structural Steel Buildings
dated March 9, 2005
and all previous versions of this specification

Approved by the AISC Committee on Specifications



AMERICAN INSTITUTE OF STEEL CONSTRUCTION
One East Wacker Drive, Suite 700
Chicago, Illinois 60601-1802

AISC © 2010

by

American Institute of Steel Construction

*All rights reserved. This book or any part thereof
must not be reproduced in any form without the
written permission of the publisher.*

The AISC logo is a registered trademark of AISC.

The information presented in this publication has been prepared in accordance with recognized engineering principles and is for general information only. While it is believed to be accurate, this information should not be used or relied upon for any specific application without competent professional examination and verification of its accuracy, suitability and applicability by a licensed professional engineer, designer or architect. The publication of the material contained herein is not intended as a representation or warranty on the part of the American Institute of Steel Construction or of any other person named herein, that this information is suitable for any general or particular use or of freedom from infringement of any patent or patents. Anyone making use of this information assumes all liability arising from such use.

Caution must be exercised when relying upon other specifications and codes developed by other bodies and incorporated by reference herein since such material may be modified or amended from time to time subsequent to the printing of this edition. The Institute bears no responsibility for such material other than to refer to it and incorporate it by reference at the time of the initial publication of this edition.

Printed in the United States of America

Second Printing: February 2012

Third Printing: February 2013

Fourth Printing: February 2015

PREFACE

(This Preface is not part of ANSI/AISC 360-10, *Specification for Structural Steel Buildings*, but is included for informational purposes only.)

This Specification is based upon past successful usage, advances in the state of knowledge, and changes in design practice. The 2010 American Institute of Steel Construction's *Specification for Structural Steel Buildings* provides an integrated treatment of allowable stress design (ASD) and load and resistance factor design (LRFD), and replaces earlier Specifications. As indicated in Chapter B of the Specification, designs can be made according to either ASD or LRFD provisions.

This Specification has been developed as a consensus document to provide a uniform practice in the design of steel-framed buildings and other structures. The intention is to provide design criteria for routine use and not to provide specific criteria for infrequently encountered problems, which occur in the full range of structural design.

This Specification is the result of the consensus deliberations of a committee of structural engineers with wide experience and high professional standing, representing a wide geographical distribution throughout the United States. The committee includes approximately equal numbers of engineers in private practice and code agencies, engineers involved in research and teaching, and engineers employed by steel fabricating and producing companies. The contributions and assistance of more than 50 additional professional volunteers working in ten task committees are also hereby acknowledged.

The Symbols, Glossary and Appendices to this Specification are an integral part of the Specification. A non-mandatory Commentary has been prepared to provide background for the Specification provisions and the user is encouraged to consult it. Additionally, non-mandatory User Notes are interspersed throughout the Specification to provide concise and practical guidance in the application of the provisions.

The reader is cautioned that professional judgment must be exercised when data or recommendations in the Specification are applied, as described more fully in the disclaimer notice preceding this Preface.

This Specification was approved by the Committee on Specifications:

James M. Fisher, Chairman	Louis F. Geschwindner
Edward E. Garvin, Vice Chairman	Lawrence G. Griffis
Hansraj G. Ashar	John L. Gross
William F. Baker	Jerome F. Hajjar
John M. Barsom	Patrick M. Hassett
William D. Bast	Tony C. Hazel
Reidar Bjorhovde	Mark V. Holland
Roger L. Brockenbrough	Ronald J. Janowiak
Gregory G. Deierlein	Richard C. Kaehler
Bruce R. Ellingwood	Lawrence A. Kloiber
Michael D. Engelhardt	Lawrence F. Kruth
Shu-Jin Fang	Jay W. Larson
Steven J. Fennes	Roberto T. Leon
John W. Fisher	James O. Malley
Theodore V. Galambos	Sanjeev R. Malushte

David L. McKenzie
 Duane K. Miller
 Larry S. Muir
 Thomas M. Murray
 R. Shankar Nair
 Jack E. Petersen
 Douglas A. Rees-Evans
 Thomas A. Sabol

Robert E. Shaw, Jr.
 Donald R. Sherman
 W. Lee Shoemaker
 William A. Thornton
 Raymond H. R. Tide
 Chia-Ming Uang
 Donald W. White
 Cynthia J. Duncan, Secretary

The Committee gratefully acknowledges the following task committee members and staff for their contribution to this document:

Allen Adams
 Farid Alfawakhiri
 Susan Burmeister
 Bruce M. Butler
 Charles J. Carter
 Helen Chen
 Bernard Cvijanovic
 Robert Disque
 Carol Drucker
 W. Samuel Easterling
 Duane Ellifritt
 Marshall T. Ferrell
 Christopher M. Foley
 Steven Freed
 Fernando Frias
 Nancy Gavlin
 Amanuel Gebremeskel
 Rodney D. Gibble
 Subhash Goel
 Arvind Goverdhan
 Kurt Gustafson
 Tom Harrington
 Todd Helwig
 Richard Henige
 Stephen Herlache
 Steve Herth
 Keith Hjelmstad
 Nestor Iwankiw
 William P. Jacobs, V
 Matthew Johann
 Daniel Kaufman
 Keith Landwehr
 Barbara Lane
 Michael Lederle
 Roberto Leon
 Andres Lepage

Brent Leu
 J. Walter Lewis
 William Lindley
 Stanley Lindsey
 LeRoy Lutz
 Bonnie Manley
 Peter Marshall
 Margaret Matthew
 Curtis L. Mayes
 William McGuire
 Saul Mednick
 James Milke
 Heath Mitchell
 Patrick Newman
 Jeffrey Packer
 Frederick Palmer
 Dhiren Panda
 Teoman Pekoz
 Clarkson Pinkham
 Thomas Poulos
 Christopher Raebel
 Thomas D. Reed
 Clinton Rex
 Benjamin Schafer
 Thomas Schlafly
 Monica Stockmann
 James Swanson
 Steven J. Thomas
 Emile Troup
 Brian Uy
 Amit H. Varma
 Sriramulu Vinnakota
 Ralph Vosters
 Robert Weber
 Michael A. West
 Ronald D. Ziemian

TABLE OF CONTENTS

SYMBOLS	xxvii
GLOSSARY	xliii
SPECIFICATION	
A. GENERAL PROVISIONS	1
A1. Scope	1
1. Seismic Applications	2
2. Nuclear Applications	2
A2. Referenced Specifications, Codes and Standards	2
A3. Material	6
1. Structural Steel Materials	6
1a. ASTM Designations	6
1b. Unidentified Steel	7
1c. Rolled Heavy Shapes	7
1d. Built-Up Heavy Shapes	7
2. Steel Castings and Forgings	8
3. Bolts, Washers and Nuts	8
4. Anchor Rods and Threaded Rods	8
5. Consumables for Welding	9
6. Headed Stud Anchors	9
A4. Structural Design Drawings and Specifications	9
B. DESIGN REQUIREMENTS	10
B1. General Provisions	10
B2. Loads and Load Combinations	10
B3. Design Basis	10
1. Required Strength	10
2. Limit States	11
3. Design for Strength Using Load and Resistance Factor Design (LRFD)	11
4. Design for Strength Using Allowable Strength Design (ASD)	11
5. Design for Stability	12
6. Design of Connections	12
6a. Simple Connections	12
6b. Moment Connections	12
7. Moment Redistribution in Beams	12
8. Diaphragms and Collectors	13
9. Design for Serviceability	13
10. Design for Ponding	13
11. Design for Fatigue	13
12. Design for Fire Conditions	13

13.	Design for Corrosion Effects	14
14.	Anchorage to Concrete	14
B4.	Member Properties	14
1.	Classification of Sections for Local Buckling	14
1a.	Unstiffened Elements	14
1b.	Stiffened Elements	15
2.	Design Wall Thickness for HSS	15
3.	Gross and Net Area Determination	18
3a.	Gross Area	18
3b.	Net Area	18
B5.	Fabrication and Erection	19
B6.	Quality Control and Quality Assurance	19
B7.	Evaluation of Existing Structures	19
C.	DESIGN FOR STABILITY	20
C1.	General Stability Requirements	20
1.	Direct Analysis Method of Design	20
2.	Alternative Methods of Design	20
C2.	Calculation of Required Strengths	21
1.	General Analysis Requirements	21
2.	Consideration of Initial Imperfections	22
2a.	Direct Modeling of Imperfections	22
2b.	Use of Notional Loads to Represent Imperfections	22
3.	Adjustments to Stiffness	24
C3.	Calculation of Available Strengths	25
D.	DESIGN OF MEMBERS FOR TENSION	26
D1.	Slenderness Limitations	26
D2.	Tensile Strength	26
D3.	Effective Net Area	27
D4.	Built-Up Members	27
D5.	Pin-Connected Members	29
1.	Tensile Strength	29
2.	Dimensional Requirements	29
D6.	Eyebars	29
1.	Tensile Strength	29
2.	Dimensional Requirements	30
E.	DESIGN OF MEMBERS FOR COMPRESSION	31
E1.	General Provisions	31
E2.	Effective Length	33
E3.	Flexural Buckling of Members without Slender Elements	33
E4.	Torsional and Flexural-Torsional Buckling of Members Without Slender Elements	34
E5.	Single Angle Compression Members	36

E6.	Built-Up Members	37
1.	Compressive Strength	37
2.	Dimensional Requirements	38
E7.	Members with Slender Elements	40
1.	Slender Unstiffened Elements, Q_s	40
2.	Slender Stiffened Elements, Q_a	43
F.	DESIGN OF MEMBERS FOR FLEXURE	44
F1.	General Provisions	46
F2.	Doubly Symmetric Compact I-Shaped Members and Channels Bent About Their Major Axis	47
1.	Yielding	47
2.	Lateral-Torsional Buckling	47
F3.	Doubly Symmetric I-Shaped Members With Compact Webs and Noncompact or Slender Flanges Bent About Their Major Axis	49
1.	Lateral-Torsional Buckling	49
2.	Compression Flange Local Buckling	49
F4.	Other I-Shaped Members With Compact or Noncompact Webs Bent About Their Major Axis	49
1.	Compression Flange Yielding	50
2.	Lateral-Torsional Buckling	50
3.	Compression Flange Local Buckling	52
4.	Tension Flange Yielding	53
F5.	Doubly Symmetric and Singly Symmetric I-Shaped Members With Slender Webs Bent About Their Major Axis	54
1.	Compression Flange Yielding	54
2.	Lateral-Torsional Buckling	54
3.	Compression Flange Local Buckling	55
4.	Tension Flange Yielding	55
F6.	I-Shaped Members and Channels Bent About Their Minor Axis	55
1.	Yielding	55
2.	Flange Local Buckling	55
F7.	Square and Rectangular HSS and Box-Shaped Members	56
1.	Yielding	56
2.	Flange Local Buckling	57
3.	Web Local Buckling	57
F8.	Round HSS	57
1.	Yielding	57
2.	Local Buckling	57
F9.	Tees and Double Angles Loaded in the Plane of Symmetry	58
1.	Yielding	58
2.	Lateral-Torsional Buckling	58
3.	Flange Local Buckling of Tees	58
4.	Local Buckling of Tee Stems in Flexural Compression	59

F10.	Single Angles	60
1.	Yielding	60
2.	Lateral-Torsional Buckling	60
3.	Leg Local Buckling	62
F11.	Rectangular Bars and Rounds	62
1.	Yielding	63
2.	Lateral-Torsional Buckling	63
F12.	Unsymmetrical Shapes	63
1.	Yielding	63
2.	Lateral-Torsional Buckling	64
3.	Local Buckling	64
F13.	Proportions of Beams and Girders	64
1.	Strength Reductions for Members With Holes in the Tension Flange	64
2.	Proportioning Limits for I-Shaped Members	64
3.	Cover Plates	65
4.	Built-Up Beams	66
5.	Unbraced Length for Moment Redistribution	66
G.	DESIGN OF MEMBERS FOR SHEAR	67
G1.	General Provisions	67
G2.	Members With Unstiffened or Stiffened Webs	67
1.	Shear Strength	67
2.	Transverse Stiffeners	69
G3.	Tension Field Action	70
1.	Limits on the Use of Tension Field Action	70
2.	Shear Strength With Tension Field Action	70
3.	Transverse Stiffeners	70
G4.	Single Angles	71
G5.	Rectangular HSS and Box-Shaped Members	71
G6.	Round HSS	72
G7.	Weak Axis Shear in Doubly Symmetric and Singly Symmetric Shapes	72
G8.	Beams and Girders with Web Openings	72
H.	DESIGN OF MEMBERS FOR COMBINED FORCES AND TORSION	73
H1.	Doubly and Singly Symmetric Members Subject to Flexure and Axial Force	73
1.	Doubly and Singly Symmetric Members Subject to Flexure and Compression	73
2.	Doubly and Singly Symmetric Members Subject to Flexure and Tension	74
3.	Doubly Symmetric Rolled Compact Members Subject to Single Axis Flexure and Compression	75

H2.	Unsymmetric and Other Members Subject to Flexure and Axial Force	76
H3.	Members Subject to Torsion and Combined Torsion, Flexure, Shear and/or Axial force	77
1.	Round and Rectangular HSS Subject to Torsion	77
2.	HSS Subject to Combined Torsion, Shear, Flexure and Axial Force	78
3.	Non-HSS Members Subject to Torsion and Combined Stress	79
H4.	Rupture of Flanges With Holes Subject to Tension	79
I.	DESIGN OF COMPOSITE MEMBERS	81
I1.	General Provisions	81
1.	Concrete and Steel Reinforcement	81
2.	Nominal Strength of Composite Sections	82
2a.	Plastic Stress Distribution Method	82
2b.	Strain Compatibility Method	82
3.	Material Limitations	82
4.	Classification of Filled Composite Sections for Local Buckling	83
I2.	Axial Force	85
1.	Encased Composite Members	85
1a.	Limitations	85
1b.	Compressive Strength	85
1c.	Tensile Strength	86
1d.	Load Transfer	86
1e.	Detailing Requirements	87
2.	Filled Composite Members	87
2a.	Limitations	87
2b.	Compressive Strength	87
2c.	Tensile Strength	88
2d.	Load Transfer	88
I3.	Flexure	88
1.	General	88
1a.	Effective Width	88
1b.	Strength During Construction	89
2.	Composite Beams With Steel Headed Stud or Steel Channel Anchors	89
2a.	Positive Flexural Strength	89
2b.	Negative Flexural Strength	89
2c.	Composite Beams With Formed Steel Deck	90
2d.	Load Transfer Between Steel Beam and Concrete Slab	90
3.	Encased Composite Members	91
4.	Filled Composite Members	92
4a.	Limitations	92
4b.	Flexural Strength	92

14.	Shear	93
1.	Filled and Encased Composite Members	93
2.	Composite Beams With Formed Steel Deck	93
15.	Combined Flexure and Axial Force	93
16.	Load Transfer	93
1.	General Requirements	93
2.	Force Allocation	94
2a.	External Force Applied to Steel Section	94
2b.	External Force Applied to Concrete	94
2c.	External Force Applied Concurrently to Steel and Concrete	94
3.	Force Transfer Mechanisms	95
3a.	Direct Bearing	95
3b.	Shear Connection	95
3c.	Direct Bond Interaction	95
4.	Detailing Requirements	96
4a.	Encased Composite Members	96
4b.	Filled Composite Members	96
17.	Composite Diaphragms and Collector Beams	96
18.	Steel Anchors	97
1.	General	97
2.	Steel Anchors in Composite Beams	97
2a.	Strength of Steel Headed Stud Anchors	97
2b.	Strength of Steel Channel Anchors	99
2c.	Required Number of Steel Anchors	99
2d.	Detailing Requirements	99
3.	Steel Anchors in Composite Components	100
3a.	Shear Strength of Steel Headed Stud Anchors in Composite Components	101
3b.	Tensile Strength of Steel Headed Stud Anchors in Composite Components	102
3c.	Strength of Steel Headed Stud Anchors for Interaction of Shear and Tension in Composite Components	102
3d.	Shear Strength of Steel Channel Anchors in Composite Components	104
3e.	Detailing Requirements in Composite Components	104
19.	Special Cases	104
J.	DESIGN OF CONNECTIONS	105
J1.	General Provisions	105
1.	Design Basis	105
2.	Simple Connections	105
3.	Moment Connections	106
4.	Compression Members With Bearing Joints	106
5.	Splices in Heavy Sections	106

6.	Weld Access Holes	107
7.	Placement of Welds and Bolts	107
8.	Bolts in Combination With Welds	107
9.	High-Strength Bolts in Combination With Rivets	108
10.	Limitations on Bolted and Welded Connections	108
J2.	Welds	108
1.	Groove Welds	108
1a.	Effective Area	108
1b.	Limitations	110
2.	Fillet Welds	110
2a.	Effective Area	110
2b.	Limitations	111
3.	Plug and Slot Welds	113
3a.	Effective Area	113
3b.	Limitations	113
4.	Strength	113
5.	Combination of Welds	117
6.	Filler Metal Requirements	117
7.	Mixed Weld Metal	118
J3.	Bolts and Threaded Parts	118
1.	High-Strength Bolts	118
2.	Size and Use of Holes	120
3.	Minimum Spacing	122
4.	Minimum Edge Distance	122
5.	Maximum Spacing and Edge Distance	122
6.	Tensile and Shear Strength of Bolts and Threaded Parts	124
7.	Combined Tension and Shear in Bearing-Type Connections	125
8.	High-Strength Bolts in Slip-Critical Connections	126
9.	Combined Tension and Shear in Slip-Critical Connections	127
10.	Bearing Strength at Bolt Holes	127
11.	Special Fasteners	128
12.	Tension Fasteners	128
J4.	Affected Elements of Members and Connecting Elements	128
1.	Strength of Elements in Tension	128
2.	Strength of Elements in Shear	129
3.	Block Shear Strength	129
4.	Strength of Elements in Compression	129
5.	Strength of Elements in Flexure	130
J5.	Fillers	130
1.	Fillers in Welded Connections	130
1a.	Thin Fillers	130
1b.	Thick Fillers	130
2.	Fillers in Bolted Connections	130

J6.	Splices	131
J7.	Bearing Strength	131
J8.	Column Bases and Bearing on Concrete	131
J9.	Anchor Rods and Embedments	132
J10.	Flanges and Webs with Concentrated Forces	133
	1. Flange Local Bending	133
	2. Web Local Yielding	134
	3. Web Local Crippling	134
	4. Web Sidesway Buckling	135
	5. Web Compression Buckling	136
	6. Web Panel Zone Shear	136
	7. Unframed Ends of Beams and Girders	138
	8. Additional Stiffener Requirements for Concentrated Forces	138
	9. Additional Doubler Plate Requirements for Concentrated Forces	138
K.	DESIGN OF HSS AND BOX MEMBER CONNECTIONS	140
K1.	Concentrated Forces on HSS	140
	1. Definitions of Parameters	140
	2. Round HSS	141
	3. Rectangular HSS	141
K2.	HSS-to-HSS Truss Connections	141
	1. Definitions of Parameters	146
	2. Round HSS	147
	3. Rectangular HSS	147
K3.	HSS-to-HSS Moment Connections	147
	1. Definitions of Parameters	154
	2. Round HSS	154
	3. Rectangular HSS	154
K4.	Welds of Plates and Branches to Rectangular HSS	154
L.	DESIGN FOR SERVICEABILITY	163
L1.	General Provisions	163
L2.	Camber	163
L3.	Deflections	163
L4.	Drift	164
L5.	Vibration	164
L6.	Wind-Induced Motion	164
L7.	Expansion and Contraction	164
L8.	Connection Slip	164
M.	FABRICATION AND ERECTION	165
M1.	Shop and Erection Drawings	165
M2.	Fabrication	165
	1. Cambering, Curving and Straightening	165
	2. Thermal Cutting	165

3.	Planing of Edges	166
4.	Welded Construction	166
5.	Bolted Construction	166
6.	Compression Joints	167
7.	Dimensional Tolerances	167
8.	Finish of Column Bases	167
9.	Holes for Anchor Rods	167
10.	Drain Holes	167
11.	Requirements for Galvanized Members	168
M3.	Shop Painting	168
1.	General Requirements	168
2.	Inaccessible Surfaces	168
3.	Contact Surfaces	168
4.	Finished Surfaces	168
5.	Surfaces Adjacent to Field Welds	168
M4.	Erection	168
1.	Column Base Setting	168
2.	Stability and Connections	169
3.	Alignment	169
4.	Fit of Column Compression Joints and Base Plates	169
5.	Field Welding	169
6.	Field Painting	169
N.	QUALITY CONTROL AND QUALITY ASSURANCE	170
N1.	Scope	170
N2.	Fabricator and Erector Quality Control Program	171
N3.	Fabricator and Erector Documents	171
1.	Submittals for Steel Construction	171
2.	Available Documents for Steel Construction	171
N4.	Inspection and Nondestructive Testing Personnel	172
1.	Quality Control Inspector Qualifications	172
2.	Quality Assurance Inspector Qualifications	173
3.	NDT Personnel Qualifications	173
N5.	Minimum Requirements for Inspection of Structural Steel Buildings	173
1.	Quality Control	173
2.	Quality Assurance	174
3.	Coordinated Inspection	174
4.	Inspection of Welding	174
5.	Nondestructive Testing of Welded Joints	177
5a.	Procedures	177
5b.	CJP Groove Weld NDT	177
5c.	Access Hole NDT	178
5d.	Welded Joints Subjected to Fatigue	178
5e.	Reduction of Rate of Ultrasonic Testing	178

5f. Increase in Rate of Ultrasonic Testing	178
5g. Documentation	179
6. Inspection of High-Strength Bolting	179
7. Other Inspection Tasks	181
N6. Minimum Requirements for Inspection of Composite Construction	181
N7. Approved Fabricators and Erectors	182
N8. Nonconforming Material and Workmanship	182
APPENDIX 1. DESIGN BY INELASTIC ANALYSIS	183
1.1. General Requirements	183
1.2. Ductility Requirements	184
1. Material	184
2. Cross Section	184
3. Unbraced Length	185
4. Axial Force	186
1.3. Analysis Requirements	186
1. Material Properties and Yield Criteria	186
2. Geometric Imperfections	187
3. Residual Stress and Partial Yielding Effects	187
APPENDIX 2. DESIGN FOR PONDING	188
2.1. Simplified Design for Ponding	188
2.2. Improved Design for Ponding	189
APPENDIX 3. DESIGN FOR FATIGUE	192
3.1. General Provisions	192
3.2. Calculation of Maximum Stresses and Stress Ranges	193
3.3. Plain Material and Welded Joints	193
3.4. Bolts and Threaded Parts	196
3.5. Special Fabrication and Erection Requirements	197
APPENDIX 4. STRUCTURAL DESIGN FOR FIRE CONDITIONS	214
4.1. General Provisions	214
4.1.1. Performance Objective	214
4.1.2. Design by Engineering Analysis	214
4.1.3. Design by Qualification Testing	215
4.1.4. Load Combinations and Required Strength	215
4.2. Structural Design for Fire Conditions by Analysis	215
4.2.1. Design-Basis Fire	215
4.2.1.1. Localized Fire	215
4.2.1.2. Post-Flashover Compartment Fires	216
4.2.1.3. Exterior Fires	216
4.2.1.4. Active Fire Protection Systems	216
4.2.2. Temperatures in Structural Systems under Fire Conditions	216
4.2.3. Material Strengths at Elevated Temperatures	216

4.2.3.1.	Thermal Elongation	216
4.2.3.2.	Mechanical Properties at Elevated Temperatures	217
4.2.4.	Structural Design Requirements	218
4.2.4.1.	General Structural Integrity	218
4.2.4.2.	Strength Requirements and Deformation Limits	218
4.2.4.3.	Methods of Analysis	219
4.2.4.3a.	Advanced Methods of Analysis	219
4.2.4.3b.	Simple Methods of Analysis	219
4.2.4.4.	Design Strength	221
4.3.	Design by Qualification Testing	221
4.3.1.	Qualification Standards	221
4.3.2.	Restrained Construction	222
4.3.3.	Unrestrained Construction	222
APPENDIX 5. EVALUATION OF EXISTING STRUCTURES		223
5.1.	General Provisions	223
5.2.	Material Properties	223
1.	Determination of Required Tests	223
2.	Tensile Properties	223
3.	Chemical Composition	224
4.	Base Metal Notch Toughness	224
5.	Weld Metal	224
6.	Bolts and Rivets	224
5.3.	Evaluation by Structural Analysis	224
1.	Dimensional Data	224
2.	Strength Evaluation	225
3.	Serviceability Evaluation	225
5.4.	Evaluation by Load Tests	225
1.	Determination of Load Rating by Testing	225
2.	Serviceability Evaluation	226
5.5.	Evaluation Report	226
APPENDIX 6. STABILITY BRACING FOR COLUMNS AND BEAMS		227
6.1.	General Provisions	227
6.2.	Column Bracing	228
1.	Relative Bracing	228
2.	Nodal Bracing	228
6.3.	Beam Bracing	229
1.	Lateral Bracing	229
1a.	Relative Bracing	229
1b.	Nodal Bracing	230
2.	Torsional Bracing	230
2a.	Nodal Bracing	230
2b.	Continuous Bracing	231

6.4	Beam-Column Bracing	232
APPENDIX 7. ALTERNATIVE METHODS OF DESIGN		
	FOR STABILITY	233
7.1.	General Stability Requirements	233
7.2.	Effective Length Method	233
	1. Limitations	233
	2. Required Strengths	233
	3. Available Strengths	234
7.3	First-Order Analysis Method	235
	1. Limitations	235
	2. Required Strengths	235
	3. Available Strengths	235
APPENDIX 8. APPROXIMATE SECOND-ORDER ANALYSIS		
8.1.	Limitations	237
8.2.	Calculation Procedure	237
	1. Multiplier B_1 for P - δ Effects	238
	2. Multiplier B_2 for P - Δ Effects	239
COMMENTARY		
INTRODUCTION		241
COMMENTARY SYMBOLS		242
COMMENTARY GLOSSARY		244
A. GENERAL PROVISIONS		
A1.	Scope	246
A2.	Referenced Specifications, Codes and Standards	247
A3.	Material	247
	1. Structural Steel Materials	247
	1a. ASTM Designations	247
	1c. Rolled Heavy Shapes	250
	2. Steel Castings and Forgings	251
	3. Bolts, Washers and Nuts	251
	4. Anchor Rods and Threaded Rods	251
	5. Consumables for Welding	251
A4.	Structural Design Drawings and Specifications	252
B. DESIGN REQUIREMENTS		
B1.	General Provisions	253
B2.	Loads and Load Combinations	254
B3.	Design Basis	256
	1. Required Strength	257
	2. Limit States	257

3.	Design for Strength Using Load and Resistance Factor Design (LRFD)	258
4.	Design for Strength Using Allowable Strength Design (ASD)	260
5.	Design for Stability	262
6.	Design of Connections	262
7.	Moment Redistribution in Beams	266
8.	Diaphragms and Collectors	266
10.	Design for Ponding	267
12.	Design for Fire Conditions	267
13.	Design for Corrosion Effects	267
B4.	Member Properties	268
1.	Classifications of Sections for Local Buckling	268
2.	Design Wall Thickness for HSS	271
3.	Gross and Net Area Determination	271
3a.	Gross Area	271
3b.	Net Area	271
C.	DESIGN FOR STABILITY	272
C1.	General Stability Requirements	272
C2.	Calculation of Required Strengths	273
1.	General Analysis Requirements	274
2.	Consideration of Initial Imperfections	279
3.	Adjustments to Stiffness	279
C3.	Calculation of Available Strengths	281
D.	DESIGN OF MEMBERS FOR TENSION	282
D1.	Slenderness Limitations	282
D2.	Tensile Strength	282
D3.	Effective Net Area	282
D4.	Built-Up Members	287
D5.	Pin-Connected Members	287
1.	Tensile Strength	287
2.	Dimensional Requirements	287
D6.	Eyebars	288
1.	Tensile Strength	288
2.	Dimensional Requirements	288
E.	DESIGN OF MEMBERS FOR COMPRESSION	290
E1.	General Provisions	290
E2.	Effective Length	292
E3.	Flexural Buckling of Members Without Slender Elements	292
E4.	Torsional and Flexural-Torsional Buckling of Members Without Slender Elements	294
E5.	Single Angle Compression Members	296
E6.	Built-Up Members	297

1.	Compressive Strength	297
2.	Dimensional Requirements	297
E7.	Members with Slender Elements	298
1.	Slender Unstiffened Elements, Q_s	299
2.	Slender Stiffened Elements, Q_a	300
F.	DESIGN OF MEMBERS FOR FLEXURE	302
F1.	General Provisions	302
F2.	Doubly Symmetric Compact I-Shaped Members and Channels Bent About Their Major Axis	308
F3.	Doubly Symmetric I-Shaped Members With Compact Webs and Noncompact or Slender Flanges Bent About Their Major Axis	310
F4.	Other I-Shaped Members with Compact or Noncompact Webs Bent About Their Major Axis	310
F5.	Doubly Symmetric and Singly Symmetric I-Shaped Members with Slender Webs Bent About Their Major Axis	312
F6.	I-Shaped Members and Channels Bent About Their Minor Axis	312
F7.	Square and Rectangular HSS and Box-Shaped Members	312
F8.	Round HSS	314
F9.	Tees and Double Angles Loaded in the Plane of Symmetry	314
F10.	Single Angles	317
1.	Yielding	318
2.	Lateral-Torsional Buckling	318
3.	Leg Local Buckling	321
F11.	Rectangular Bars and Rounds	322
F12.	Unsymmetrical Shapes	323
F13.	Proportions of Beams and Girders	323
1.	Strength Reductions for Members With Holes in the Tension Flange	323
2.	Proportioning Limits for I-Shaped Members	323
3.	Cover Plates	324
5.	Unbraced Length for Moment Redistribution	324
G.	DESIGN OF MEMBERS FOR SHEAR	325
G1.	General Provisions	325
G2.	Members With Unstiffened or Stiffened Webs	325
1.	Shear Strength	325
2.	Transverse Stiffeners	327
G3.	Tension Field Action	327
1.	Limits on the Use of Tension Field Action	327
2.	Shear Strength With Tension Field Action	328
3.	Transverse Stiffeners	328
G4.	Single Angles	328
G5.	Rectangular HSS and Box-Shaped Members	329

G6.	Round HSS	330
G7.	Weak Axis Shear in Doubly and Singly Symmetric Shapes	330
G8.	Beams and Girders with Web Openings	330
H.	DESIGN OF MEMBERS FOR COMBINED FORCES AND TORSION	331
H1.	Doubly and Singly Symmetric Members Subject to Flexure and Axial Force	331
1.	Doubly and Singly Symmetric Members Subject to Flexure and Compression	331
2.	Doubly and Singly Symmetric Members in Flexure and Tension	335
3.	Doubly Symmetric Rolled Compact Members Subject to Single Axis Flexure and Compression	335
H2.	Unsymmetric and Other Members Subject to Flexure and Axial Force	338
H3.	Members Subject to Torsion and Combined Torsion, Flexure, Shear and/or Axial Force	341
1.	Round and Rectangular HSS Subject to Torsion	341
2.	HSS Subject to Combined Torsion, Shear, Flexure and Axial Force	342
3.	Non-HSS Members Subject to Torsion and Combined Stress	343
H4.	Rupture of Flanges With Holes Subject to Tension	343
I.	DESIGN OF COMPOSITE MEMBERS	344
I1.	General Provisions	345
1.	Concrete and Steel Reinforcement	345
2.	Nominal Strength of Composite Sections	346
2a.	Plastic Stress Distribution Method	346
2b.	Strain-Compatibility Approach	347
3.	Material Limitations	347
4.	Classification of Filled Composite Sections for Local Buckling	348
I2.	Axial Force	349
1.	Encased Composite Members	350
1a.	Limitations	350
1b.	Compressive Strength	350
1c.	Tensile Strength	351
2.	Filled Composite Members	351
2a.	Limitations	351
2b.	Compressive Strength	351
2c.	Tensile Strength	352
I3.	Flexure	352
1.	General	352
1a.	Effective Width	353
1b.	Strength During Construction	353
2.	Composite Beams With Steel Headed Stud or Steel Channel Anchors	353

2a.	Positive Flexural Strength	357
2b.	Negative Flexural Strength	359
2c.	Composite Beams With Formed Steel Deck	360
2d.	Load Transfer Between Steel Beam and Concrete Slab	360
3.	Encased Composite Members	362
4.	Filled Composite Members	363
14.	Shear	365
1.	Filled and Encased Composite Members	365
2.	Composite Beams With Formed Steel Deck	365
15.	Combined Flexure and Axial Force	365
16.	Load Transfer	370
1.	General Requirements	370
2.	Force Allocation	370
3.	Force Transfer Mechanisms	371
3a.	Direct Bearing	371
3b.	Shear Connection	372
3c.	Direct Bond Interaction	372
4.	Detailing Requirements	372
17.	Composite Diaphragms and Collector Beams	374
18.	Steel Anchors	376
1.	General	376
2.	Steel Anchors in Composite Beams	377
2a.	Strength of Steel Headed Stud Anchors	377
2b.	Strength of Steel Channel Anchors	379
2d.	Detailing Requirements	380
3.	Steel Anchors in Composite Components	380
19.	Special Cases	382
J.	DESIGN OF CONNECTIONS	383
J1.	General Provisions	383
1.	Design Basis	383
2.	Simple Connections	383
3.	Moment Connections	383
4.	Compression Members With Bearing Joints	384
5.	Splices in Heavy Sections	384
6.	Weld Access Holes	386
7.	Placement of Welds and Bolts	387
8.	Bolts in Combination With Welds	388
9.	High-Strength Bolts in Combination With Rivets	388
10.	Limitations on Bolted and Welded Connections	388
J2.	Welds	388
1.	Groove Welds	389
1a.	Effective Area	389

1b.	Limitations	389
2.	Fillet Welds	389
2a.	Effective Area	389
2b.	Limitations	389
3.	Plug and Slot Welds	395
3a.	Effective Area	395
3b.	Limitations	395
4.	Strength	396
5.	Combination of Welds	400
6.	Filler Metal Requirements	400
7.	Mixed Weld Metal	400
J3.	Bolts and Threaded Parts	400
1.	High-Strength Bolts	400
2.	Size and Use of Holes	401
3.	Minimum Spacing	402
4.	Minimum Edge Distance	402
5.	Maximum Spacing and Edge Distance	402
6.	Tension and Shear Strength of Bolts and Threaded Parts	402
7.	Combined Tension and Shear in Bearing-Type Connections	404
8.	High-Strength Bolts in Slip-Critical Connections	406
9.	Combined Tension and Shear in Slip-Critical Connections	410
10.	Bearing Strength at Bolt Holes	410
12.	Tension Fasteners	411
J4.	Affected Elements of Members and Connecting Elements	411
1.	Strength of Elements in Tension	411
2.	Strength of Elements in Shear	411
3.	Block Shear Strength	411
4.	Strength of Elements in Compression	413
J5.	Fillers	413
J7.	Bearing Strength	413
J8.	Column Bases and Bearing on Concrete	414
J9.	Anchor Rods and Embedments	414
J10.	Flanges and Webs with Concentrated Forces	415
1.	Flange Local Bending	416
2.	Web Local Yielding	417
3.	Web Local Crippling	417
4.	Web Sidesway Buckling	418
5.	Web Compression Buckling	418
6.	Web Panel-Zone Shear	419
7.	Unframed Ends of Beams and Girders	421
8.	Additional Stiffener Requirements for Concentrated Forces	422
9.	Additional Doubler Plate Requirements for Concentrated Forces	423

K. DESIGN OF HSS AND BOX MEMBER CONNECTIONS	425
K1. Concentrated Forces on HSS	425
1. Definitions of Parameters	425
2. Round HSS	425
3. Rectangular HSS	425
K2. HSS-to-HSS Truss Connections	428
1. Definitions of Parameters	431
2. Round HSS	431
3. Rectangular HSS	433
K3. HSS-to-HSS Moment Connections	436
K4. Welds of Plates and Branches to Rectangular HSS	437
L. DESIGN FOR SERVICEABILITY	439
L1. General Provisions	439
L2. Camber	440
L3. Deflections	440
L4. Drift	441
L5. Vibration	442
L6. Wind-Induced Motion	443
L7. Expansion and Contraction	444
L8. Connection Slip	444
M. FABRICATION AND ERECTION	445
M1. Shop and Erection Drawings	445
M2. Fabrication	445
1. Cambering, Curving and Straightening	445
2. Thermal Cutting	445
4. Welded Construction	446
5. Bolted Construction	446
10. Drain Holes	446
11. Requirements for Galvanized Members	447
M3. Shop Painting	448
1. General Requirements	448
3. Contact Surfaces	448
5. Surfaces Adjacent to Field Welds	448
M4. Erection	448
2. Stability and Connections	448
4. Fit of Column Compression Joints and Base Plates	448
5. Field Welding	449
N. QUALITY CONTROL AND QUALITY ASSURANCE	450
N1. Scope	450
N2. Fabricator and Erector Quality Control Program	451
N3. Fabricator and Erector Documents	452
1. Submittals for Steel Construction	452

- 2. Available Documents for Steel Construction 452
- N4. Inspection and Nondestructive Testing Personnel 453
 - 1. Quality Control Inspector Qualifications 453
 - 2. Quality Assurance Inspector Qualifications 453
 - 3. NDT Personnel Qualifications 453
- N5. Minimum Requirements for Inspection of Structural Steel Buildings 454
 - 1. Quality Control 454
 - 2. Quality Assurance 454
 - 3. Coordinated Inspection 455
 - 4. Inspection of Welding 456
 - 5. Nondestructive Testing of Welded Joints 460
 - 5a. Procedures 460
 - 5b. CJP Groove Weld NDT 460
 - 5c. Access Hole NDT 462
 - 5d. Welded Joints Subjected to Fatigue 462
 - 5e. Reduction of Rate of Ultrasonic Testing 462
 - 5f. Increase in Rate of Ultrasonic Testing 463
 - 6. Inspection of High-Strength Bolting 463
 - 7. Other Inspection Tasks 464
- N6. Minimum Requirements for Inspection of Composite Construction 466
- N7. Approved Fabricators and Erectors 466
- APPENDIX 1. DESIGN BY INELASTIC ANALYSIS 468**
 - 1.1. General Requirements 468
 - 1.2. Ductility Requirements 470
 - 1. Material 471
 - 2. Cross Section 471
 - 3. Unbraced Length 472
 - 4. Axial Force 473
 - 1.3. Analysis Requirements 473
 - 1. Material Properties and Yield Criteria 474
 - 2. Geometric Imperfections 474
 - 3. Residual Stresses and Partial Yielding Effects 474
- APPENDIX 2. DESIGN FOR PONDING 476**
- APPENDIX 3. DESIGN FOR FATIGUE 479**
 - 3.1. General 479
 - 3.2. Calculation of Maximum Stresses and Stress Ranges 479
 - 3.3. Plain Material and Welded Joints 480
 - 3.4. Bolts and Threaded Parts 481
 - 3.5. Special Fabrication and Erection Requirements 482
- APPENDIX 4. STRUCTURAL DESIGN FOR FIRE CONDITIONS 483**
 - 4.1. General Provisions 483

4.1.1.	Performance Objective	483
4.1.2.	Design by Engineering Analysis	483
4.1.4.	Load Combinations and Required Strength	484
4.2.	Structural Design for Fire Conditions by Analysis	485
4.2.1.	Design-Basis Fire	485
4.2.1.1.	Localized Fire	485
4.2.1.2.	Post-Flashover Compartment Fires	485
4.2.1.3.	Exterior Fires	486
4.2.1.4.	Active Fire Protection Systems	486
4.2.2.	Temperatures in Structural Systems Under Fire Conditions	486
4.2.3.	Material Strengths at Elevated Temperatures	490
4.2.4.	Structural Design Requirements	491
4.2.4.1.	General Structural Integrity	491
4.2.4.2.	Strength Requirements and Deformation Limits	491
4.2.4.3.	Methods of Analysis	491
4.2.4.3a.	Advanced Methods of Analysis	491
4.2.4.3b.	Simple Methods of Analysis	492
4.2.4.4.	Design Strength	492
4.3.	Design by Qualification Testing	493
4.3.1.	Qualification Standards	493
4.3.2.	Restrained Construction	493
4.3.3.	Unrestrained Construction	494
	Bibliography	495
APPENDIX 5. EVALUATION OF EXISTING STRUCTURES		497
5.1.	General Provisions	497
5.2.	Material Properties	497
1.	Determination of Required Tests	497
2.	Tensile Properties	497
4.	Base Metal Notch Toughness	498
5.	Weld Metal	498
6.	Bolts and Rivets	498
5.3.	Evaluation by Structural Analysis	498
2.	Strength Evaluation	498
5.4.	Evaluation by Load Tests	499
1.	Determination of Load Rating by Testing	499
2.	Serviceability Evaluation	499
5.5.	Evaluation Report	500
APPENDIX 6. STABILITY BRACING FOR COLUMNS AND BEAMS		501
6.1.	General Provisions	501
6.2.	Column Bracing	504
6.3.	Beam Bracing	505
1.	Lateral Bracing	506
2.	Torsional Bracing	506

6.4	Beam-Column Bracing	508
APPENDIX 7. ALTERNATIVE METHODS OF DESIGN FOR STABILITY ..		509
7.2.	Effective Length Method	509
7.3.	First-Order Analysis Method	518
APPENDIX 8. APPROXIMATE SECOND-ORDER ANALYSIS		520
REFERENCES		527

SYMBOLS

Some definitions in the list below have been simplified in the interest of brevity. In all cases, the definitions given in the body of the *Specification* govern. Symbols without text definitions, used only in one location and defined at that location are omitted in some cases. The section or table number in the right-hand column refers to the Section where the symbol is first used.

Symbol	Definition	Section
A_{BM}	Cross-sectional area of the base metal, in. ² (mm ²)	J2.4
A_b	Nominal unthreaded body area of bolt or threaded part, in. ² (mm ²)	J3.6
A_{bi}	Cross-sectional area of the overlapping branch, in. ² (mm ²)	K2.3
A_{bj}	Cross-sectional area of the overlapped branch, in. ² (mm ²)	K2.3
A_c	Area of concrete, in. ² (mm ²)	I2.1b
A_c	Area of concrete slab within effective width, in. ² (mm ²)	I3.2d
A_e	Effective net area, in. ² (mm ²)	D2
A_e	Summation of the effective areas of the cross section based on the reduced effective width, b_e , in. ² (mm ²)	E7.2
A_{fc}	Area of compression flange, in. ² (mm ²)	G3.1
A_{fg}	Gross area of tension flange, in. ² (mm ²)	F13.1
A_{fn}	Net area of tension flange, in. ² (mm ²)	F13.1
A_{ft}	Area of tension flange, in. ² (mm ²)	G3.1
A_g	Gross cross-sectional area of member, in. ² (mm ²)	B3.7
A_g	Gross area of composite member, in. ² (mm ²)	I2.1
A_{gv}	Gross area subject to shear, in. ² (mm ²)	J4.3
A_n	Net area of member, in. ² (mm ²)	B4.3
A_n	Area of the directly connected elements, in. ² (mm ²)	Table D3.1
A_{nt}	Net area subject to tension, in. ² (mm ²)	J4.3
A_{nv}	Net area subject to shear, in. ² (mm ²)	J4.3
A_{pb}	Projected area in bearing, in. ² (mm ²)	J7
A_s	Cross-sectional area of steel section, in. ² (mm ²)	I2.1b
A_{sa}	Cross-sectional area of steel headed stud anchor, in. ² (mm ²)	I8.2a
A_{sf}	Area on the shear failure path, in. ² (mm ²)	D5.1
A_{sr}	Area of continuous reinforcing bars, in. ² (mm ²)	I2.1
A_{sr}	Area of adequately developed longitudinal reinforcing steel within the effective width of the concrete slab, in. ² (mm ²)	I3.2d
A_t	Net area in tension, in. ² (mm ²)	App. 3.4
A_w	Area of web, the overall depth times the web thickness, dt_w , in. ² (mm ²)	G2.1
A_{we}	Effective area of the weld, in. ² (mm ²)	J2.4
A_{wei}	Effective area of weld throat of any i th weld element, in. ² (mm ²)	J2.4
A_1	Loaded area of concrete, in. ² (mm ²)	I6.3a
A_1	Area of steel concentrically bearing on a concrete support, in. ² (mm ²)	J8

Symbol	Definition	Section
A_2	Maximum area of the portion of the supporting surface that is geometrically similar to and concentric with the loaded area, in. ² (mm ²) . . .	J8
B	Overall width of rectangular HSS member, measured 90 ° to the plane of the connection, in. (mm)	Table D3.1
B	Overall width of rectangular steel section along face transferring load, in. (mm)	I6.3c
B_b	Overall width of rectangular HSS branch member, measured 90 ° to the plane of the connection, in. (mm)	K2.1
B_{bi}	Overall width of the overlapping branch, in. (mm)	K2.3
B_{bj}	Overall width of the overlapped branch, in. (mm)	K2.3
B_p	Width of plate, measured 90 ° to the plane of the connection, in. (mm)	K1.1
B_1	Multiplier to account for P - δ effects	App.8.2
B_2	Multiplier to account for P - Δ effects	App.8.2
C	HSS torsional constant	H3.1
C_b	Lateral-torsional buckling modification factor for nonuniform moment diagrams	F1
C_d	Coefficient accounting for increased required bracing stiffness at inflection point	App. 6.3.1
C_f	Constant from Table A-3.1 for the fatigue category	App. 3.3
C_m	Coefficient accounting for nonuniform moment	App. 8.2.1
C_p	Ponding flexibility coefficient for primary member in a flat roof	App. 2.1
C_r	Coefficient for web sidesway buckling	J10.4
C_s	Ponding flexibility coefficient for secondary member in a flat roof	App. 2.1
C_v	Web shear coefficient	G2.1
C_w	Warping constant, in. ⁶ (mm ⁶)	E4
C_2	Edge distance increment	Table J3.5
D	Outside diameter of round HSS, in. (mm)	Table B4.1
D	Outside diameter of round HSS main member, in. (mm)	K2.1
D	Nominal dead load, kips (N)	App. 2.2
D_b	Outside diameter of round HSS branch member, in. (mm)	K2.1
D_u	In slip-critical connections, a multiplier that reflects the ratio of the mean installed bolt pretension to the specified minimum bolt pretension	J3.8
E	Modulus of elasticity of steel = 29,000 ksi (200 000 MPa)	Table B4.1
E_c	Modulus of elasticity of concrete = $w_c^{1.5} \sqrt{f'_c}$, ksi ($0.043w_c^{1.5} \sqrt{f'_c}$, MPa)	I2.1b
$E_c(T)$	Modulus of elasticity of concrete at elevated temperature, ksi (MPa)	App. 4.2.3.2
E_s	Modulus of elasticity of steel = 29,000 ksi (200 000 MPa)	I2.1b
$E(T)$	Elastic modulus of elasticity of steel at elevated temperature, ksi (MPa)	App. 4.2.4.3

Symbol	Definition	Section
EI_{eff}	Effective stiffness of composite section, kip-in. ² (N-mm ²)	I2.1b
F_c	Available stress, ksi (MPa)	K1.1
F_{ca}	Available axial stress at the point of consideration, ksi (MPa)	H2
F_{cbw}, F_{cbz}	Available flexural stress at the point of consideration, ksi (MPa)	H2
F_{cr}	Critical stress, ksi (MPa)	E3
F_{cry}	Critical stress about the y-axis of symmetry, ksi (MPa)	E4
F_{crz}	Critical torsional buckling stress, ksi (MPa)	E4
F_e	Elastic buckling stress, ksi (MPa)	E3
$F_e(T)$	Critical elastic buckling stress with the elastic modulus $E(T)$ at elevated temperature, ksi (MPa)	App. 4.2.4.3
F_{ex}	Flexural elastic buckling stress about the major principal axis, ksi (MPa)	E4
F_{EXX}	Filler metal classification strength, ksi (MPa)	J2.4
F_{ey}	Flexural elastic buckling stress about the major principal axis, ksi (MPa)	E4
F_{ez}	Torsional elastic buckling stress, ksi (MPa)	E4
F_{in}	Nominal bond stress, 0.06 ksi (0.40 MPa)	I6.3c
F_L	Magnitude of flexural stress in compression flange at which flange local buckling or lateral-torsional buckling is influenced by yielding, ksi (MPa)	Table B4.1
F_n	Nominal stress, ksi (MPa)	H3.3
F_n	Nominal tensile stress, F_{nt} , or shear stress, F_{nv} , from Table J3.2, ksi (MPa)	J3.6
F_{nBM}	Nominal stress of the base metal, ksi (MPa)	J2.4
F_{nt}	Nominal tensile stress from Table J3.2, ksi (MPa)	J3.7
F'_{nt}	Nominal tensile stress modified to include the effects of shear stress, ksi (MPa)	J3.7
F_{nv}	Nominal shear stress from Table J3.2, ksi (MPa)	J3.7
F_{nw}	Nominal stress of the weld metal, ksi (MPa)	J2.4
F_{nw}	Nominal stress of the weld metal (Chapter J) with no increase in strength due to directionality of load, ksi (MPa)	K4
F_{nwi}	Nominal stress in i th weld element, ksi (MPa)	J2.4
F_{nwix}	x component of nominal stress, F_{nwi} , ksi (MPa)	J2.4
F_{nwiy}	y component of nominal stress, F_{nwi} , ksi (MPa)	J2.4
$F_p(T)$	Proportional limit at elevated temperatures, ksi (MPa)	App. 4.2.3.2
F_{SR}	Allowable stress range, ksi (MPa)	App. 3.3
F_{TH}	Threshold allowable stress range, maximum stress range for indefinite design life from Table A-3.1, ksi (MPa)	App. 3.1
F_u	Specified minimum tensile strength, ksi (MPa)	D2
$F_u(T)$	Minimum tensile strength at elevated temperature, ksi (MPa) . . .	App. 4.2.3.2
F_y	Specified minimum yield stress, ksi (MPa). As used in this Specification, “yield stress” denotes either the specified minimum yield point (for those steels that have a yield point) or specified yield strength (for those steels that do not have a yield point)	B3.7

Symbol	Definition	Section
F_{yb}	Specified minimum yield stress of HSS branch member material, ksi (MPa)	K2.1
F_{ybi}	Specified minimum yield stress of the overlapping branch material, ksi (MPa)	K2.3
F_{ybj}	Specified minimum yield stress of the overlapped branch material, ksi (MPa)	K2.3
F_{yf}	Specified minimum yield stress of the flange, ksi (MPa)	J10.1
F_{yp}	Specified minimum yield stress of plate, ksi (MPa)	K1.1
F_{ysr}	Specified minimum yield stress of reinforcing bars, ksi (MPa)	I2.1b
F_{yst}	Specified minimum yield stress of the stiffener material, ksi (MPa)	G3.3
$F_y(T)$	Yield stress at elevated temperature, ksi (MPa)	App. 4.2.4.3
F_{yw}	Specified minimum yield stress of the web material, ksi (MPa)	G3.3
G	Shear modulus of elasticity of steel = 11,200 ksi (77 200 MPa)	E4
$G(T)$	Shear modulus of elasticity of steel at elevated temperature, ksi (MPa)	App. 4.2.3.2
H	Flexural constant	E4
H	Story shear, in the direction of translation being considered, produced by the lateral forces used to compute Δ_H , kips (N)	App. 8.2.2
H	Overall height of rectangular HSS member, measured in the plane of the connection, in. (mm)	Table D3.1
H_b	Overall height of rectangular HSS branch member, measured in the plane of the connection, in. (mm)	K2.1
H_{bi}	Overall depth of the overlapping branch, in. (mm)	K2.3
I	Moment of inertia in the plane of bending, in. ⁴ (mm ⁴)	App. 8.2.1
I_c	Moment of inertia of the concrete section about the elastic neutral axis of the composite section, in. ⁴ (mm ⁴)	I2.1b
I_d	Moment of inertia of the steel deck supported on secondary members, in. ⁴ (mm ⁴)	App. 2.1
I_p	Moment of inertia of primary members, in. ⁴ (mm ⁴)	App. 2.1
I_s	Moment of inertia of secondary members, in. ⁴ (mm ⁴)	App. 2.1
I_s	Moment of inertia of steel shape about the elastic neutral axis of the composite section, in. ⁴ (mm ⁴)	I2.1b
I_{sr}	Moment of inertia of reinforcing bars about the elastic neutral axis of the composite section, in. ⁴ (mm ⁴)	I2.1b
I_{st}	Moment of inertia of transverse stiffeners about an axis in the web center for stiffener pairs, or about the face in contact with the web plate for single stiffeners, in. ⁴ (mm ⁴)	G3.3
I_{st1}	Minimum moment of inertia of transverse stiffeners required for development of the web shear buckling resistance in Section G2.2, in. ⁴ (mm ⁴)	G3.3
I_{st2}	Minimum moment of inertia of transverse stiffeners required for development of the full web shear buckling plus the web tension field resistance, $V_r = V_{c2}$, in. ⁴ (mm ⁴)	G3.3
I_x, I_y	Moment of inertia about the principal axes, in. ⁴ (mm ⁴)	E4

Symbol	Definition	Section
I_y	Out-of-plane moment of inertia, in. ⁴ (mm ⁴)	App. 6.3.2a
I_{yc}	Moment of inertia of the compression flange about the y -axis, in. ⁴ (mm ⁴)	F4.2
I_z	Minor principal axis moment of inertia, in. ⁴ (mm ⁴)	F10.2
J	Torsional constant, in. ⁴ (mm ⁴)	E4
K	Effective length factor	C3, E2
K_x	Effective length factor for flexural buckling about x -axis	E4
K_y	Effective length factor for flexural buckling about y -axis	E4
K_z	Effective length factor for torsional buckling	E4
K_1	Effective length factor in the plane of bending, calculated based on the assumption of no lateral translation at the member ends, set equal to 1.0 unless analysis justifies a smaller value	App. 8.2.1
L	Height of story, in. (mm)	App. 7.3.2
L	Length of member, in. (mm)	H3.1
L	Nominal occupancy live load	App. 4.1.4
L	Laterally unbraced length of member, in. (mm)	E2
L	Length of span, in. (mm)	App. 6.3.2a
L	Length of member between work points at truss chord centerlines, in. (mm)	E5
L_b	Length between points that are either braced against lateral displacement of compression flange or braced against twist of the cross section, in. (mm)	F2.2
L_b	Distance between braces, in. (mm)	App. 6.2
L_b	Largest laterally unbraced length along either flange at the point of load, in. (mm)	J10.4
L_m	Limiting laterally unbraced length for eligibility for moment redistribution in beams according to Section B3.7	F13.5
L_p	Limiting laterally unbraced length for the limit state of yielding, in. (mm)	F2.2
L_p	Length of primary members, ft (m)	App. 2.1
L_{pd}	Limiting laterally unbraced length for plastic analysis, in. (mm)	App. 1.2.3
L_r	Limiting laterally unbraced length for the limit state of inelastic lateral-torsional buckling, in. (mm)	F2.2
L_s	Length of secondary members, ft (m)	App. 2.1
L_v	Distance from maximum to zero shear force, in. (mm)	G6
M_A	Absolute value of moment at quarter point of the unbraced segment, kip-in. (N-mm)	F1
M_a	Required flexural strength using ASD load combinations, kip-in. (N-mm)	J10.4
M_B	Absolute value of moment at centerline of the unbraced segment, kip-in. (N-mm)	F1
M_C	Absolute value of moment at three-quarter point of the unbraced segment, kip-in. (N-mm)	F1
M_{cx}, M_{cy}	Available flexural strength determined in accordance with Chapter F, kip-in. (N-mm)	H1.1

Symbol	Definition	Section
M_{cx}	Available lateral-torsional strength for strong axis flexure determined in accordance with Chapter F using $C_b = 1.0$, kip-in. (N-mm)	H1.3
M_{cx}	Available flexural strength about the x -axis for the limit state of tensile rupture of the flange, kip-in. (N-mm)	H4
M_e	Elastic lateral-torsional buckling moment, kip-in. (N-mm)	F10.2
M_{lt}	First-order moment using LRFD or ASD load combinations, due to lateral translation of the structure only, kip-in. (N-mm)	App. 8.2
M_{max}	Absolute value of maximum moment in the unbraced segment, kip-in. (N-mm)	F1
M_{mid}	Moment at the middle of the unbraced length, kip-in. (N-mm)	App. 1.2.3
M_n	Nominal flexural strength, kip-in. (N-mm)	F1
M_{nt}	First-order moment using LRFD or ASD load combinations, with the structure restrained against lateral translation, kip-in. (N-mm)	App. 8.2
M_p	Plastic bending moment, kip-in. (N-mm)	Table B4.1
M_p	Moment corresponding to plastic stress distribution over the composite cross section, kip-in. (N-mm)	I3.4b
M_r	Required second-order flexural strength under LRFD or ASD load combinations, kip-in. (N-mm)	App. 8.2
M_r	Required flexural strength using LRFD or ASD load combinations, kip-in. (N-mm)	H1.1
M_{rb}	Required bracing moment using LRFD or ASD load combinations, kip-in. (N-mm)	App. 6.3.2
M_{r-ip}	Required in-plane flexural strength in branch using LRFD or ASD load combinations, kip-in. (N-mm)	K3.2
M_{r-op}	Required out-of-plane flexural strength in branch using LRFD or ASD load combinations, kip-in. (N-mm)	K3.2
M_{rx}, M_{ry}	Required flexural strength, kip-in. (N-mm)	H1.1
M_{rx}	Required flexural strength at the location of the bolt holes; positive for tension in the flange under consideration, negative for compression, kip-in. (N-mm)	H4
M_u	Required flexural strength using LRFD load combinations, kip-in. (N-mm)	J10.4
M_y	Moment at yielding of the extreme fiber, kip-in. (N-mm)	Table B4.1
M_y	Yield moment about the axis of bending, kip-in. (N-mm)	F10.1
M_{yc}	Moment at yielding of the extreme fiber in the compression flange, kip-in. (N-mm)	F4.2
M_{yt}	Moment at yielding of the extreme fiber in the tension flange, kip-in. (N-mm)	F4.4
M_1'	Effective moment at the end of the unbraced length opposite from M_2 , kip-in. (N-mm)	App. 1.2.3
M_1	Smaller moment at end of unbraced length, kip-in. (N-mm)	F13.5, App. 1.2.3
M_2	Larger moment at end of unbraced length, kip-in. (N-mm)	F13.5, App. 1.2.3

Symbol	Definition	Section
N_i	Notional load applied at level i , kips (N)	C2.2b
N_i	Additional lateral load, kips (N)	App. 7.3
O_v	Overlap connection coefficient	K2.2
P_c	Available axial strength, kips (N)	H1.1
P_{cy}	Available compressive strength out of the plane of bending, kips (N) . . .	H1.3
P_e	Elastic critical buckling load determined in accordance with Chapter C or Appendix 7, kips (N)	I2.1b
$P_{e \text{ story}}$	Elastic critical buckling strength for the story in the direction of translation being considered, kips (N)	App 8.2.2
P_{ey}	Elastic critical buckling load for buckling about the weak axis, kips (N)	H1.2
P_{e1}	Elastic critical buckling strength of the member in the plane of bending, kips (N)	App. 8.2.1
P_{lt}	First-order axial force using LRFD or ASD load combinations, due to lateral translation of the structure only, kips (N)	App. 8.2
P_{mf}	Total vertical load in columns in the story that are part of moment frames, if any, in the direction of translation being considered, kips (N)	App. 8.2.2
P_n	Nominal axial strength, kips (N)	D2
P_n	Nominal compressive strength, kips (N)	E1
P_{no}	Nominal compressive strength of zero length, doubly symmetric, axially loaded composite member, kips (N)	I2
P_{nt}	First-order axial force using LRFD and ASD load combinations, with the structure restrained against lateral translation, kips (N)	App. 8.2
P_p	Nominal bearing strength, kips (N)	J8
P_r	Required second-order axial strength using LRFD or ASD load combinations, kips (N)	App. 8.2
P_r	Required axial compressive strength using LRFD or ASD load combinations, kips (N)	C2.3
P_r	Required axial strength using LRFD or ASD load combinations, kips (N)	H1.1
P_r	Required axial strength of the member at the location of the bolt holes; positive in tension, negative in compression, kips (N)	H4
P_r	Required external force applied to the composite member, kips (N)	I6.2a
P_{rb}	Required brace strength using LRFD or ASD load combinations, kips (N)	App. 6.2
P_{ro}	Required axial strength in chord at a joint, on the side of joint with lower compression stress, kips (N)	Table K1.1
P_{story}	Total vertical load supported by the story using LRFD or ASD load combinations, as applicable, including loads in columns that are not part of the lateral force resisting system, kips (N)	App. 8.2.2
P_u	Required axial strength in chord using LRFD load combinations, kips (N)	K1.1
P_u	Required axial strength in compression, kips (N)	App. 1.2.2
P_y	Axial yield strength, kips (N)	C2.3
Q	Net reduction factor accounting for all slender compression elements	E7

Symbol	Definition	Section
Q_a	Reduction factor for slender stiffened elements	E7.2
Q_{ct}	Available tensile strength, kips (N)	I8.3c
Q_{cv}	Available shear strength, kips (N)	I8.3c
Q_f	Chord-stress interaction parameter	K2.2
Q_n	Nominal strength of one steel headed stud or steel channel anchor, kips (N)	I3.2
Q_{nt}	Nominal tensile strength of steel headed stud anchor, kips (N)	I8.3b
Q_{nv}	Nominal shear strength of steel headed stud anchor, kips (N)	I8.3a
Q_{rt}	Required tensile strength, kips (N)	I8.3c
Q_{rv}	Required shear strength, kips (N)	I8.3c
Q_s	Reduction factor for slender unstiffened elements	E7.1
R	Radius of joint surface, in. (mm)	Table J2.2
R	Nominal load due to rainwater or snow, exclusive of the ponding contribution, ksi (MPa)	App. 2.2
R	Seismic response modification coefficient	A1.1
R_a	Required strength using ASD load combinations	B3.4
R_{FIL}	Reduction factor for joints using a pair of transverse fillet welds only	App. 3.3
R_g	Coefficient to account for group effect	I8.2a
R_M	Coefficient to account for influence of $P-\delta$ on $P-\Delta$	App. 8.2.2
R_n	Nominal strength, specified in Chapters B through K	B3.3
R_n	Nominal slip resistance, kips (N)	J3.8
R_n	Nominal strength of the applicable force transfer mechanism, kips (N)	I6.3
R_{nwl}	Total nominal strength of longitudinally loaded fillet welds, as determined in accordance with Table J2.5, kips (N)	J2.4
R_{nwt}	Total nominal strength of transversely loaded fillet welds, as determined in accordance with Table J2.5 without the alternate in Section J2.4(a), kips (N)	J2.4
R_{nx}	Horizontal component of the nominal strength of a weld group, kips (N)	J2.4
R_{ny}	Vertical component of the nominal strength of a weld group, kips (N)	J2.4
R_p	Position effect factor for shear studs	I8.2a
R_{pc}	Web plastification factor	F4.1
R_{pg}	Bending strength reduction factor	F5.2
R_{PJP}	Reduction factor for reinforced or nonreinforced transverse partial-joint-penetration (PJP) groove welds	App. 3.3
R_{pt}	Web plastification factor corresponding to the tension flange yielding limit state	F4.4
R_u	Required strength using LRFD load combinations	B3.3
S	Elastic section modulus, in. ³ (mm ³)	F8.2
S	Spacing of secondary members, ft (m)	App. 2.1
S	Nominal snow load	App. 4.1.4
S_c	Elastic section modulus to the toe in compression relative to the axis of bending, in. ³ (mm ³).	F10.3

Symbol	Definition	Section
S_e	Effective section modulus about major axis, in. ³ (mm ³)	F7.2
S_{ip}	Effective elastic section modulus of welds for in-plane bending (Table K4.1), in. ³ (mm ³)	K4
S_{min}	Lowest elastic section modulus relative to the axis of bending, in. ³ (mm ³)	F12
S_{op}	Effective elastic section modulus of welds for out-of-plane bending (Table K4.1), in. ³ (mm ³)	K4
S_{xc}, S_{xt}	Elastic section modulus referred to compression and tension flanges, respectively, in. ³ (mm ³)	Table B4.1
S_x	Elastic section modulus taken about the <i>x</i> -axis, in. ³ (mm ³)	F2.2
S_y	Elastic section modulus taken about the <i>y</i> -axis. For a channel, the minimum section modulus, in. ³ (mm ³)	F6.2
T	Nominal forces and deformations due to the design-basis fire defined in Appendix Section 4.2.1	App. 4.1.4
T_a	Required tension force using ASD load combinations, kips (N)	J3.9
T_b	Minimum fastener tension given in Table J3.1 or J3.1M, kips (N)	J3.8
T_c	Available torsional strength, kip-in. (N-mm)	H3.2
T_n	Nominal torsional strength, kip-in. (N-mm)	H3.1
T_r	Required torsional strength using LRFD or ASD load combinations, kip-in. (N-mm)	H3.2
T_u	Required tension force using LRFD load combinations, kips (N)	J3.9
U	Shear lag factor	D3
U	Utilization ratio	K2.2
U_{bs}	Reduction coefficient, used in calculating block shear rupture strength	J4.3
U_p	Stress index for primary members	App. 2.2
U_s	Stress index for secondary members	App. 2.2
V'	Nominal shear force between the steel beam and the concrete slab transferred by steel anchors, kips (N)	I3.2d
V_c	Available shear strength, kips (N)	H3.2
V_{c1}	Smaller of the available shear strengths in the adjacent web panels with V_n as defined in Section G2.1, kips (N)	G3.3
V_{c2}	Smaller of the available shear strengths in the adjacent web panels with V_n as defined in Section G3.2, kips (N)	G3.3
V_n	Nominal shear strength, kips (N)	G1
V_r	Larger of the required shear strengths in the adjacent web panels using LRFD or ASD load combinations, kips (N)	G3.3
V_r	Required shear strength using LRFD or ASD load combinations, kips (N)	H3.2
V'_r	Required longitudinal shear force to be transferred to the steel or concrete, kips (N)	I6.2
Y_i	Gravity load applied at level <i>i</i> from the LRFD load combination or ASD load combination, as applicable, kips (N)	C2.2b, App. 7.3.2
Z	Plastic section modulus about the axis of bending, in. ³ (mm ³)	F7.1

Symbol	Definition	Section
Z_b	Plastic section modulus of branch about the axis of bending, in. ³ (mm ³)	K3.1
Z_x	Plastic section modulus about the x -axis, in. ³ (mm ³)	F2.1
Z_y	Plastic section modulus about the y -axis, in. ³ (mm ³)	F6.1
a	Clear distance between transverse stiffeners, in. (mm)	F13.2
a	Distance between connectors, in. (mm)	E6.1
a	Shortest distance from edge of pin hole to edge of member measured parallel to the direction of force, in. (mm)	D5.1
a	Half the length of the nonwelded root face in the direction of the thickness of the tension-loaded plate, in. (mm)	App. 3.3
a'	Weld length along both edges of the cover plate termination to the beam or girder, in. (mm)	F13.3
a_w	Ratio of two times the web area in compression due to application of major axis bending moment alone to the area of the compression flange components	F4.2
b	Full width of leg in compression, in. (mm)	F10.3
b	For flanges of I-shaped members, half the full-flange width, b_f ; for flanges of channels, the full nominal dimension of the flange, in. (mm)	F6.2
b	Full width of longest leg, in. (mm)	E7.1
b	Width of unstiffened compression element; width of stiffened compression element, in. (mm)	B4.1
b	Width of the leg resisting the shear force, in. (mm)	G4
b_{cf}	Width of column flange, in. (mm)	J10.6
b_e	Reduced effective width, in. (mm)	E7.2
b_e	Effective edge distance for calculation of tensile rupture strength of pin-connected member, in. (mm)	D5.1
b_{eoi}	Effective width of the branch face welded to the chord, in. (mm)	K2.3
b_{eov}	Effective width of the branch face welded to the overlapped brace, in. (mm)	K2.3
b_f	Width of flange, in. (mm)	B4.1
b_{fc}	Width of compression flange, in. (mm)	F4.2
b_{ft}	Width of tension flange, in. (mm)	G3.1
b_l	Length of longer leg of angle, in. (mm)	E5
b_s	Length of shorter leg of angle, in. (mm)	E5
b_s	Stiffener width for one-sided stiffeners, in. (mm)	App. 6.3.2
d	Nominal fastener diameter, in. (mm)	J3.3
d	Nominal bolt diameter, in. (mm)	J3.10
d	Full nominal depth of the section, in. (mm)	B4.1, J10.3
d	Depth of rectangular bar, in. (mm)	F11.2
d	Diameter, in. (mm)	J7
d	Diameter of pin, in. (mm)	D5.1
d_b	Depth of beam, in. (mm)	J10.6
d_b	Nominal diameter (body or shank diameter), in. (mm)	App. 3.4
d_c	Depth of column, in. (mm)	J10.6

Symbol	Definition	Section
e	Eccentricity in a truss connection, positive being away from the branches, in. (mm)	K2.1
e_{mid-ht}	Distance from the edge of steel headed stud anchor shank to the steel deck web, in. (mm)	I8.2a
f'_c	Specified compressive strength of concrete, ksi (MPa)	I1.2b
$f'_c(T)$	Compressive strength of concrete at elevated temperature, ksi (MPa)	I1.2b
f_o	Stress due to $D + R$ (D = nominal dead load, R = nominal load due to rainwater or snow exclusive of the ponding contribution), ksi (MPa)	App. 2.2
f_{ra}	Required axial stress at the point of consideration using LRFD or ASD load combinations, ksi (MPa)	H2
f_{rbw}, f_{rbz}	Required flexural stress at the point of consideration using LRFD or ASD load combinations, ksi (MPa)	H2
f_{rv}	Required shear stress using LRFD or ASD load combinations, ksi (MPa)	J3.7
g	Transverse center-to-center spacing (gage) between fastener gage lines, in. (mm)	B4.3
g	Gap between toes of branch members in a gapped K-connection, neglecting the welds, in. (mm)	K2.1
h	Width of stiffened compression element, in. (mm)	B4.1
h	Height of shear element, in. (mm)	G2.1b
h	Clear distance between flanges less the fillet or corner radius for rolled shapes; distance between adjacent lines of fasteners or the clear distance between flanges when welds are used for built-up shapes, in. (mm)	J10.4
h_c	Twice the distance from the center of gravity to the following: the inside face of the compression flange less the fillet or corner radius, for rolled shapes; the nearest line of fasteners at the compression flange or the inside faces of the compression flange when welds are used, for built-up sections, in. (mm)	B4.1
h_o	Distance between the flange centroids, in. (mm)	F2.2
h_p	Twice the distance from the plastic neutral axis to the nearest line of fasteners at the compression flange or the inside face of the compression flange when welds are used, in. (mm)	B4.1
h_r	Nominal height of rib, in. (mm)	I8.2a
k	Distance from outer face of flange to the web toe of fillet, in. (mm)	J10.2
k_c	Coefficient for slender unstiffened elements	Table B4.1
k_{sc}	Slip-critical combined tension and shear coefficient	J3.9
k_v	Web plate shear buckling coefficient	G2.1
l	Actual length of end-loaded weld, in. (mm)	J2.2
l	Length of connection, in. (mm)	Table D3.1
l_b	Length of bearing, in. (mm)	J7
l_c	Clear distance, in the direction of the force, between the edge of the hole and the edge of the adjacent hole or edge of the material, in. (mm)	J3.10

Symbol	Definition	Section
l_{ca}	Length of channel anchor, in. (mm)	I8.2b
l_e	Total effective weld length of groove and fillet welds to rectangular HSS for weld strength calculations, in. (mm)	K4
l_{ov}	Overlap length measured along the connecting face of the chord beneath the two branches, in. (mm)	K2.1
l_p	Projected length of the overlapping branch on the chord, in. (mm)	K2.1
n	Number of nodal braced points within the span	App. 6.3
n	Threads per inch (per mm)	App. 3.4
n_b	Number of bolts carrying the applied tension	J3.9
n_s	Number of slip planes required to permit the connection to slip	J3.8
n_{SR}	Number of stress range fluctuations in design life	App. 3.3
p	Pitch, in. per thread (mm per thread)	App. 3.4
p_i	Ratio of element i deformation to its deformation at maximum stress	J2.4
r	Radius of gyration, in. (mm)	E2
r_{cr}	Distance from instantaneous center of rotation to weld element with minimum Δ_u/r_i ratio, in. (mm)	J2.4
r_i	Minimum radius of gyration of individual component, in. (mm)	E6.1
r_i	Distance from instantaneous center of rotation to i th weld element, in. (mm)	J2.4
\bar{r}_o	Polar radius of gyration about the shear center, in. (mm)	E4
r_t	Radius of gyration of the flange components in flexural compression plus one-third of the web area in compression due to application of major axis bending moment alone, in. (mm)	F4.2
r_{ts}	Effective radius of gyration, in. (mm)	F2.2
r_x	Radius of gyration about the x -axis, in. (mm)	E4
r_x	Radius of gyration about the geometric axis parallel to the connected leg, in. (mm)	E5
r_y	Radius of gyration about y -axis, in. (mm)	E4
r_z	Radius of gyration about the minor principal axis, in. (mm)	E5
s	Longitudinal center-to-center spacing (pitch) of any two consecutive holes, in. (mm)	B4.3
t	Thickness of element, in. (mm)	E7.1
t	Thickness of wall, in. (mm)	E7.2
t	Thickness of angle leg, in. (mm)	F10.2
t	Width of rectangular bar parallel to axis of bending, in. (mm)	F11.2
t	Thickness of connected material, in. (mm)	J3.10
t	Thickness of plate, in. (mm)	D5.1
t	Total thickness of fillers, in. (mm)	J5.2
t	Design wall thickness of HSS member, in. (mm)	B4.1, K1.1
t_b	Design wall thickness of HSS branch member, in. (mm)	K2.1
t_{bi}	Thickness of overlapping branch, in. (mm)	K2.3
t_{bj}	Thickness of overlapped branch, in. (mm)	K2.3
t_{cf}	Thickness of column flange, in. (mm)	J10.6
t_f	Thickness of flange, in. (mm)	F6.2
t_f	Thickness of loaded flange, in. (mm)	J10.1

Symbol	Definition	Section
t_f	Thickness of flange of channel anchor, in. (mm)	I8.2b
t_{fc}	Thickness of compression flange, in. (mm)	F4.2
t_p	Thickness of plate, in. (mm)	K1.1
t_p	Thickness of tension loaded plate, in. (mm)	App. 3.3
t_{st}	Thickness of web stiffener, in. (mm)	App. 6.3.2a
t_w	Thickness of web, in. (mm)	Table B4.1
t_w	Smallest effective weld throat thickness around the perimeter of branch or plate, in. (mm)	K4
t_w	Thickness of channel anchor web, in. (mm)	I8.2b
w	Width of cover plate, in. (mm)	F13.3
w	Size of weld leg, in. (mm)	J2.2
w	Subscript relating symbol to major principal axis bending	H2
w	Width of plate, in. (mm)	Table D3.1
w	Leg size of the reinforcing or contouring fillet, if any, in the direction of the thickness of the tension-loaded plate, in. (mm)	App. 3.3
w_c	Weight of concrete per unit volume ($90 \leq w_c \leq 155$ lbs/ft ³ or $1500 \leq w_c \leq 2500$ kg/m ³)	I2.1
w_r	Average width of concrete rib or haunch, in. (mm)	I3.2
x	Subscript relating symbol to strong axis bending	H1.1
x_i	x component of r_i	J2.4
x_o, y_o	Coordinates of the shear center with respect to the centroid, in. (mm)	E4
\bar{x}	Eccentricity of connection, in. (mm)	Table D3.1
y	Subscript relating symbol to weak axis bending	H1.1
y_i	y component of r_i	J2.4
z	Subscript relating symbol to minor principal axis bending	H2
α	ASD/LRFD force level adjustment factor	C2.3
β	Reduction factor given by Equation J2-1	J2.2
β	Width ratio; the ratio of branch diameter to chord diameter for round HSS; the ratio of overall branch width to chord width for rectangular HSS	K2.1
β_T	Overall brace system stiffness, kip-in./rad (N-mm/rad)	App. 6.3.2a
β_{br}	Required brace stiffness, kips/in. (N/mm)	App. 6.2.1
β_{eff}	Effective width ratio; the sum of the perimeters of the two branch members in a K-connection divided by eight times the chord width	K2.1
β_{eop}	Effective outside punching parameter	K2.3
β_{sec}	Web distortional stiffness, including the effect of web transverse stiffeners, if any, kip-in./rad (N-mm/rad)	App. 6.3.2a
β_{Tb}	Required torsional stiffness for nodal bracing, kip-in./rad (N-mm/rad)	App. 6.3.2a
β_w	Section property for unequal leg angles, positive for short legs in compression and negative for long legs in compression	F10.2
Δ	First-order interstory drift due to the LRFD or ASD load combinations, in. (mm)	App. 7.3.2
Δ_H	First-order interstory drift due to lateral forces, in. (mm)	App. 8.2.2

Symbol	Definition	Section
Δ_i	Deformation of weld elements at intermediate stress levels, linearly proportioned to the critical deformation based on distance from the instantaneous center of rotation, r_i , in. (mm)	J2.4
Δ_{mi}	Deformation of weld element at maximum stress, in. (mm)	J2.4
Δ_{ui}	Deformation of weld element at ultimate stress (rupture), usually in element furthest from instantaneous center of rotation, in. (mm)	J2.4
$\varepsilon_{cu}(T)$	Maximum concrete strain at elevated temperature, %	App. 4.2.3.2
γ	Chord slenderness ratio; the ratio of one-half the diameter to the wall thickness for round HSS; the ratio of one-half the width to wall thickness for rectangular HSS	K2.1
ζ	Gap ratio; the ratio of the gap between the branches of a gapped K-connection to the width of the chord for rectangular HSS	K2.1
η	Load length parameter, applicable only to rectangular HSS; the ratio of the length of contact of the branch with the chord in the plane of the connection to the chord width	K2.1
λ	Slenderness parameter	F3.2
λ_p	Limiting slenderness parameter for compact element	B4
λ_{pd}	Limiting slenderness parameter for plastic design	App. 1.2
λ_{pf}	Limiting slenderness parameter for compact flange	F3.2
λ_{pw}	Limiting slenderness parameter for compact web	F4
λ_r	Limiting slenderness parameter for noncompact element	B4
λ_{rf}	Limiting slenderness parameter for noncompact flange	F3.2
λ_{rw}	Limiting slenderness parameter for noncompact web	F4.2
μ	Mean slip coefficient for Class A or B surfaces, as applicable, or as established by tests	J3.8
ϕ	Resistance factor, specified in Chapters B through K	B3.3
ϕ_B	Resistance factor for bearing on concrete	I6.3a
ϕ_b	Resistance factor for flexure	F1
ϕ_c	Resistance factor for compression	B3.7
ϕ_c	Resistance factor for axially loaded composite columns	I2.1b
ϕ_{sf}	Resistance factor for shear on the failure path	D5.1
ϕ_T	Resistance factor for torsion	H3.1
ϕ_t	Resistance factor for tension	D2
ϕ_t	Resistance factor for steel headed stud anchor in tension	I8.3b
ϕ_v	Resistance factor for shear	G1
ϕ_v	Resistance factor for steel headed stud anchor in shear	I8.3a
Ω	Safety factor, specified in Chapters B through K	B3.4
Ω_B	Safety factor for bearing on concrete	I6.1
Ω_b	Safety factor for flexure	F1
Ω_c	Safety factor for compression	B3.7
Ω_c	Safety factor for axially loaded composite columns	I2.1b
Ω_{sf}	Safety factor for shear on the failure path	D5.1
Ω_T	Safety factor for torsion	H3.1
Ω_t	Safety factor for tension	D2

Symbol	Definition	Section
Ω_t	Safety factor for steel headed stud anchor in tension	I8.3b
Ω_v	Safety factor for shear	G1
Ω_v	Safety factor for steel headed stud anchor in shear	I8.3a
ρ_{sr}	Minimum reinforcement ratio for longitudinal reinforcing	I2.1
ρ_{st}	The larger of F_{yw}/F_{yst} and 1.0	G3.3
θ	Angle of loading measured from the weld longitudinal axis, degrees	J2.4
θ	Acute angle between the branch and chord, degrees	K2.1
θ_i	Angle of loading measured from the longitudinal axis of <i>i</i> th weld element, degrees	J2.4
τ_b	Stiffness reduction parameter	C2.3

GLOSSARY

Terms defined in this Glossary are *italicized* in the Glossary and where they first appear within a section or long paragraph throughout the Specification.

Notes:

- (1) Terms designated with † are common AISI-AISC terms that are coordinated between the two standards development organizations.
- (2) Terms designated with * are usually qualified by the type of *load effect*; for example, *nominal tensile strength*, *available compressive strength*, and *design flexural strength*.
- (3) Terms designated with ** are usually qualified by the type of component; for example, *web local buckling* and *flange local bending*.

Active fire protection. Building materials and systems that are activated by a fire to mitigate adverse effects or to notify people to take some action to mitigate adverse effects.

Allowable strength†.* *Nominal strength* divided by the *safety factor*, R_n/Ω .

Allowable stress.* *Allowable strength* divided by the appropriate section property, such as section modulus or cross-section area.

Applicable building code†. Building code under which the structure is designed.

ASD (allowable strength design)†. Method of proportioning *structural components* such that the *allowable strength* equals or exceeds the *required strength* of the component under the action of the *ASD load combinations*.

ASD load combination†. Load combination in the *applicable building code* intended for allowable strength design (*allowable stress design*).

Authority having jurisdiction (AHJ). Organization, political subdivision, office or individual charged with the responsibility of administering and enforcing the provisions of the *applicable building code*.

Available strength†.* *Design strength* or *allowable strength*, as appropriate.

Available stress.* Design stress or *allowable stress*, as appropriate.

Average rib width. In a *formed steel deck*, average width of the rib of a corrugation.

Batten plate. Plate rigidly connected to two parallel components of a built-up *column* or *beam* designed to transmit shear between the components.

Beam. Nominally horizontal structural member that has the primary function of resisting bending moments.

Beam-column. Structural member that resists both axial force and bending moment.

Bearing†. In a *connection*, *limit state* of shear forces transmitted by the mechanical *fastener* to the connection elements.

Bearing (local compressive yielding)†. *Limit state* of *local compressive yielding* due to the action of a member bearing against another member or surface.

Bearing-type connection. Bolted *connection* where shear *forces* are transmitted by the bolt bearing against the connection elements.

- Block shear rupture*†. In a *connection*, *limit state* of tension rupture along one path and shear yielding or shear rupture along another path.
- Braced frame*†. Essentially vertical truss system that provides resistance to lateral forces and provides stability for the *structural system*.
- Bracing*. Member or system that provides stiffness and strength to limit the out-of-plane movement of another member at a brace point.
- Branch member*. In an *HSS connection*, member that terminates at a *chord member* or *main member*.
- Buckling*†. *Limit state* of sudden change in the geometry of a structure or any of its elements under a critical loading condition.
- Buckling strength*. Strength for *instability limit states*.
- Built-up member; cross section, section, shape*. Member, cross section, section or shape fabricated from structural steel elements that are welded or bolted together.
- Camber*. Curvature fabricated into a *beam* or truss so as to compensate for deflection induced by loads.
- Charpy V-notch impact test*. Standard dynamic test measuring notch toughness of a specimen.
- Chord member*. In an *HSS connection*, primary member that extends through a truss connection.
- Cladding*. Exterior covering of structure.
- Cold-formed steel structural member*†. Shape manufactured by press-braking blanks sheared from sheets, cut lengths of coils or plates, or by roll forming cold- or hot-rolled coils or sheets; both forming operations being performed at ambient room temperature, that is, without manifest addition of heat such as would be required for hot forming.
- Collector*. Also known as drag strut; member that serves to transfer loads between floor *diaphragms* and the members of the *lateral force resisting system*.
- Column*. Nominally vertical structural member that has the primary function of resisting axial compressive force.
- Column base*. Assemblage of structural shapes, plates, connectors, bolts and rods at the base of a *column* used to transmit forces between the steel superstructure and the foundation.
- Compact section*. Section capable of developing a fully plastic stress distribution and possessing a *rotation capacity* of approximately three before the onset of *local buckling*.
- Compartmentation*. Enclosure of a building space with elements that have a specific fire endurance.
- Complete-joint-penetration (CJP) groove weld*. *Groove weld* in which weld metal extends through the *joint* thickness, except as permitted for *HSS connections*.
- Composite*. Condition in which steel and concrete elements and members work as a unit in the distribution of internal forces.
- Composite beam*. Structural steel *beam* in contact with and acting compositely with a reinforced concrete slab.

Composite component. Member, connecting element or assemblage in which steel and concrete elements work as a unit in the distribution of internal forces, with the exception of the special case of *composite beams* where *steel anchors* are embedded in a solid concrete slab or in a slab cast on *formed steel deck*.

Concrete breakout surface. The surface delineating a volume of concrete surrounding a steel headed stud anchor that separates from the remaining concrete.

Concrete crushing. Limit state of compressive failure in concrete having reached the ultimate strain.

Concrete haunch. In a *composite* floor system constructed using a *formed steel deck*, the section of solid concrete that results from stopping the deck on each side of the *girder*.

Concrete-encased beam. Beam totally encased in concrete cast integrally with the slab.

Connection†. Combination of structural elements and *joints* used to transmit forces between two or more members.

Construction documents. *Design drawings*, *specifications*, shop drawings and erection drawings.

Cope. Cutout made in a structural member to remove a flange and conform to the shape of an intersecting member.

Cover plate. Plate welded or bolted to the flange of a member to increase cross-sectional area, section modulus or moment of inertia.

Cross connection. *HSS connection* in which forces in *branch members* or connecting elements transverse to the *main member* are primarily equilibrated by forces in other branch members or connecting elements on the opposite side of the main member.

Design-basis fire. Set of conditions that define the development of a *fire* and the spread of combustion products throughout a building or portion thereof.

Design drawings. Graphic and pictorial documents showing the design, location and dimensions of the work. These documents generally include plans, elevations, sections, details, schedules, diagrams and notes.

Design load†. Applied *load* determined in accordance with either *LFRD load combinations* or *ASD load combinations*, whichever is applicable.

*Design strength**†. Resistance factor multiplied by the *nominal strength*, ϕR_n .

Design wall thickness. *HSS* wall thickness assumed in the determination of section properties.

Diagonal stiffener. Web stiffener at *column panel zone* oriented diagonally to the flanges, on one or both sides of the web.

Diaphragm†. Roof, floor or other membrane or bracing system that transfers in-plane forces to the *lateral force resisting system*.

Diaphragm plate. Plate possessing in-plane shear stiffness and strength, used to transfer forces to the supporting elements.

Direct analysis method. Design method for stability that captures the effects of residual stresses and initial out-of-plumbness of frames by reducing stiffness and applying *notional loads* in a second-order analysis.

- Direct bond interaction.* In a *composite* section, mechanism by which force is transferred between steel and concrete by bond stress.
- Distortional failure.* Limit state of an HSS truss *connection* based on distortion of a rectangular HSS chord member into a rhomboidal shape.
- Distortional stiffness.* Out-of-plane flexural stiffness of web.
- Double curvature.* Deformed shape of a *beam* with one or more inflection points within the span.
- Double-concentrated forces.* Two equal and opposite forces applied normal to the same flange, forming a couple.
- Doubler.* Plate added to, and parallel with, a *beam* or *column* web to increase strength at locations of concentrated forces.
- Drift.* Lateral deflection of structure.
- Effective length.* Length of an otherwise identical *column* with the same strength when analyzed with pinned end conditions.
- Effective length factor, K.* Ratio between the *effective length* and the *unbraced length* of the member.
- Effective net area.* Net area modified to account for the effect of *shear lag*.
- Effective section modulus.* Section modulus reduced to account for buckling of slender compression elements.
- Effective width.* Reduced width of a plate or slab with an assumed uniform stress distribution which produces the same effect on the behavior of a structural member as the actual plate or slab width with its nonuniform stress distribution.
- Elastic analysis.* *Structural analysis* based on the assumption that the structure returns to its original geometry on removal of the *load*.
- Elevated temperatures.* Heating conditions experienced by building elements or structures as a result of *fire* which are in excess of the anticipated ambient conditions.
- Encased composite member.* Composite member consisting of a structural concrete member and one or more embedded steel shapes.
- End panel.* Web panel with an adjacent panel on one side only.
- End return.* Length of *fillet weld* that continues around a corner in the same plane.
- Engineer of record.* Licensed professional responsible for sealing the *design drawings* and *specifications*.
- Expansion rocker.* Support with curved surface on which a member bears that can tilt to accommodate expansion.
- Expansion roller.* Round steel bar on which a member bears that can roll to accommodate expansion.
- Eyebar.* Pin-connected tension member of uniform thickness, with forged or thermally cut head of greater width than the body, proportioned to provide approximately equal strength in the head and body.
- Factored load* †. Product of a *load factor* and the *nominal load*.
- Fastener.* Generic term for bolts, rivets or other connecting devices.

Fatigue†. *Limit state* of crack initiation and growth resulting from repeated application of *live loads*.

Faying surface. Contact surface of *connection* elements transmitting a shear force.

Filled composite member. *Composite member* consisting of a shell of *HSS* filled with structural concrete.

Filler. Plate used to build up the thickness of one component.

Filler metal. Metal or alloy added in making a welded *joint*.

Fillet weld. Weld of generally triangular cross section made between intersecting surfaces of elements.

Fillet weld reinforcement. *Fillet welds* added to *groove welds*.

Finished surface. Surfaces fabricated with a roughness height value measured in accordance with ANSI/ASME B46.1 that is equal to or less than 500.

Fire. Destructive burning, as manifested by any or all of the following: light, flame, heat or smoke.

Fire barrier. Element of construction formed of fire-resisting materials and tested in accordance with an approved standard *fire resistance* test, to demonstrate compliance with the *applicable building code*.

Fire resistance. Property of assemblies that prevents or retards the passage of excessive heat, hot gases or flames under conditions of use and enables them to continue to perform a stipulated function.

First-order analysis. *Structural analysis* in which equilibrium conditions are formulated on the undeformed structure; *second-order effects* are neglected.

Fitted bearing stiffener. *Stiffener* used at a support or concentrated *load* that fits tightly against one or both flanges of a *beam* so as to transmit load through bearing.

Flare bevel groove weld. Weld in a groove formed by a member with a curved surface in contact with a planar member.

Flare V-groove weld. Weld in a groove formed by two members with curved surfaces.

Flashover. Transition to a state of total surface involvement in a fire of combustible materials within an enclosure.

Flat width. Nominal width of rectangular *HSS* minus twice the outside corner radius. In the absence of knowledge of the corner radius, the flat width may be taken as the total section width minus three times the thickness.

Flexural buckling†. *Buckling* mode in which a compression member deflects laterally without twist or change in cross-sectional shape.

Flexural-torsional buckling†. *Buckling* mode in which a compression member bends and twists simultaneously without change in cross-sectional shape.

Force. Resultant of distribution of stress over a prescribed area.

Formed section. See *cold-formed steel structural member*.

Formed steel deck. In *composite* construction, steel cold formed into a decking profile used as a permanent concrete form.

Fully restrained moment connection. Connection capable of transferring moment with negligible rotation between connected members.

Gage. Transverse center-to-center spacing of *fasteners*.

Gapped connection. HSS truss connection with a gap or space on the *chord* face between intersecting *branch members*.

Geometric axis. Axis parallel to web, flange or angle leg.

Girder. See *Beam*.

Girder filler. In a *composite* floor system constructed using a *formed steel deck*, narrow piece of *sheet steel* used as a fill between the edge of a deck sheet and the flange of a *girder*.

Gouge. Relatively smooth surface groove or cavity resulting from plastic deformation or removal of material.

Gravity load. Load acting in the downward direction, such as dead and live loads.

Grip (of bolt). Thickness of material through which a bolt passes.

Groove weld. Weld in a groove between *connection* elements. See also AWS D1.1/D1.1M.

Gusset plate. Plate element connecting truss members or a strut or brace to a *beam* or *column*.

Heat flux. Radiant energy per unit surface area.

Heat release rate. Rate at which thermal energy is generated by a burning material.

High-strength bolt. Fastener in compliance with ASTM A325, A325M, A490, A490M, F1852, F2280 or an alternate fastener as permitted in Section J3.1.

Horizontal shear. In a *composite beam*, *force* at the interface between steel and concrete surfaces.

HSS. Square, rectangular or round hollow structural steel section produced in accordance with a *pipe* or *tubing* product *specification*.

Inelastic analysis. *Structural analysis* that takes into account inelastic material behavior, including *plastic analysis*.

In-plane instability†. *Limit state* involving *buckling* in the plane of the frame or the member.

Instability†. *Limit state* reached in the loading of a structural component, frame or structure in which a slight disturbance in the *loads* or geometry produces large displacements.

Introduction length. In an *encased composite column*, the length along which the *column force* is assumed to be transferred into or out of the steel shape.

Joint†. Area where two or more ends, surfaces or edges are attached. Categorized by type of *fastener* or weld used and method of *force* transfer.

Joint eccentricity. In an HSS truss connection, perpendicular distance from *chord member* center of gravity to intersection of *branch member* work points.

k-area. The region of the web that extends from the tangent point of the web and the flange-web fillet (AISC *k* dimension) a distance $1\frac{1}{2}$ in. (38 mm) into the web beyond the *k* dimension.

- K-connection.* *HSS connection* in which forces in *branch members* or connecting elements transverse to the *main member* are primarily equilibrated by forces in other branch members or connecting elements on the same side of the main member.
- Lacing.* Plate, angle or other steel shape, in a lattice configuration, that connects two steel shapes together.
- Lap joint.* Joint between two overlapping *connection* elements in parallel planes.
- Lateral bracing.* Member or system that is designed to inhibit lateral *buckling* or *lateral-torsional buckling* of structural members.
- Lateral force resisting system.* Structural system designed to resist lateral loads and provide *stability* for the structure as a whole.
- Lateral load.* Load acting in a lateral direction, such as wind or earthquake effects.
- Lateral-torsional buckling*†. Buckling mode of a flexural member involving deflection out of the plane of bending occurring simultaneously with twist about the shear center of the cross section.
- Leaning column.* Column designed to carry *gravity loads* only, with *connections* that are not intended to provide resistance to *lateral loads*.
- Length effects.* Consideration of the reduction in strength of a member based on its *unbraced length*.
- Lightweight concrete.* Structural concrete with an equilibrium density of 115 lb/ft³ (1840 kg/m³) or less as determined by ASTM C567.
- Limit state*†. Condition in which a structure or component becomes unfit for service and is judged either to be no longer useful for its intended function (*serviceability limit state*) or to have reached its ultimate load-carrying capacity (*strength limit state*).
- Load*†. Force or other action that results from the weight of building materials, occupants and their possessions, environmental effects, differential movement or restrained dimensional changes.
- Load effect*†. Forces, stresses and deformations produced in a *structural component* by the applied loads.
- Load factor*†. Factor that accounts for deviations of the *nominal load* from the actual load, for uncertainties in the analysis that transforms the load into a *load effect* and for the probability that more than one extreme load will occur simultaneously.
- Local bending*** †. *Limit state* of large deformation of a flange under a concentrated transverse force.
- Local buckling***†. *Limit state* of buckling of a compression element within a cross section.
- Local yielding***†. Yielding that occurs in a local area of an element.
- LRFD (load and resistance factor design)*†. Method of proportioning *structural components* such that the *design strength* equals or exceeds the *required strength* of the component under the action of the *LRFD load combinations*.
- LRFD load combination*†. Load combination in the *applicable building code* intended for strength design (*load and resistance factor design*).

Main member. In an *HSS connection*, *chord member*, *column* or other *HSS member* to which *branch members* or other connecting elements are attached.

Mechanism. *Structural system* that includes a sufficient number of real hinges, *plastic hinges* or both, so as to be able to articulate in one or more rigid body modes.

Mill scale. Oxide surface coating on steel formed by the hot rolling process.

Moment connection. *Connection* that transmits bending moment between connected members.

Moment frame†. Framing system that provides resistance to lateral loads and provides stability to the *structural system*, primarily by shear and flexure of the framing members and their *connections*.

Negative flexural strength. Flexural strength of a *composite beam* in regions with tension due to flexure on the top surface.

Net area. Gross area reduced to account for removed material.

Nodal brace. Brace that prevents lateral movement or twist independently of other braces at adjacent brace points (see *relative brace*).

Nominal dimension. Designated or theoretical dimension, as in tables of section properties.

Nominal load†. Magnitude of the *load* specified by the *applicable building code*.

Nominal rib height. In a *formed steel deck*, height of deck measured from the underside of the lowest point to the top of the highest point.

*Nominal strength**†. Strength of a structure or component (without the *resistance factor* or *safety factor* applied) to resist *load effects*, as determined in accordance with this *Specification*.

Noncompact section. Section that can develop the *yield stress* in its compression elements before *local buckling* occurs, but cannot develop a *rotation capacity* of three.

Nondestructive testing. Inspection procedure wherein no material is destroyed and the integrity of the material or component is not affected.

Notch toughness. Energy absorbed at a specified temperature as measured in the *Charpy V-notch impact test*.

Notional load. Virtual *load* applied in a *structural analysis* to account for destabilizing effects that are not otherwise accounted for in the design provisions.

Out-of-plane buckling†. *Limit state* of a *beam*, *column* or *beam-column* involving lateral or lateral-torsional buckling.

Overlapped connection. *HSS truss connection* in which intersecting *branch members* overlap.

Panel zone. Web area of *beam-to-column connection* delineated by the extension of beam and column flanges through the connection, transmitting moment through a shear panel.

Partial-joint-penetration (PJP) groove weld. *Groove weld* in which the penetration is intentionally less than the complete thickness of the connected element.

Partially restrained moment connection. *Connection* capable of transferring moment with rotation between connected members that is not negligible.

Percent elongation. Measure of ductility, determined in a tensile test as the maximum elongation of the gage length divided by the original gage length expressed as a percentage.

Pipe. See *HSS*.

Pitch. Longitudinal center-to-center spacing of *fasteners*. Center-to-center spacing of bolt threads along axis of bolt.

Plastic analysis. *Structural analysis* based on the assumption of rigid-plastic behavior, that is, that equilibrium is satisfied and the *stress* is at or below the *yield stress* throughout the structure.

Plastic hinge. Fully yielded zone that forms in a structural member when the *plastic moment* is attained.

Plastic moment. Theoretical resisting moment developed within a fully yielded cross section.

Plastic stress distribution method. In a *composite* member, method for determining *stresses* assuming that the steel section and the concrete in the cross section are fully plastic.

Plastification. In an *HSS connection*, *limit state* based on an out-of-plane flexural yield line mechanism in the *chord* at a *branch member* connection.

Plate girder. Built-up *beam*.

Plug weld. Weld made in a circular hole in one element of a *joint* fusing that element to another element.

Ponding. Retention of water due solely to the deflection of flat roof framing.

Positive flexural strength. Flexural strength of a *composite beam* in regions with compression due to flexure on the top surface.

Pretensioned bolt. Bolt tightened to the specified minimum pretension.

Pretensioned joint. *Joint* with high-strength bolts tightened to the specified minimum pretension.

Properly developed. Reinforcing bars detailed to yield in a ductile manner before crushing of the concrete occurs. Bars meeting the provisions of ACI 318, insofar as development length, spacing and cover, are deemed to be properly developed.

Prying action. Amplification of the tension force in a bolt caused by leverage between the point of applied *load*, the bolt and the reaction of the connected elements.

Punching load. In an *HSS connection*, component of *branch member* force perpendicular to a *chord*.

P- δ effect. Effect of *loads* acting on the deflected shape of a member between joints or nodes.

P- Δ effect. Effect of *loads* acting on the displaced location of joints or nodes in a structure. In tiered building structures, this is the effect of loads acting on the laterally displaced location of floors and roofs.

Quality assurance. Monitoring and inspection tasks performed by an agency or firm other than the fabricator or erector to ensure that the material provided and work performed by the fabricator and erector meet the requirements of the approved *construction documents* and referenced standards. *Quality assurance* includes those tasks designated “special inspection” by the *applicable building code*.

- Quality assurance inspector (QAI)*. Individual designated to provide *quality assurance* inspection for the work being performed.
- Quality assurance plan (QAP)*. Program in which the agency or firm responsible for *quality assurance* maintains detailed monitoring and inspection procedures to ensure conformance with the approved *construction documents* and referenced standards.
- Quality control*. Controls and inspections implemented by the fabricator or erector, as applicable, to ensure that the material provided and work performed meet the requirements of the approved *construction documents* and referenced standards.
- Quality control inspector (QCI)*. Individual designated to perform *quality control* inspection tasks for the work being performed.
- Quality control program (QCP)*. Program in which the fabricator or erector, as applicable, maintains detailed fabrication or erection and inspection procedures to ensure conformance with the approved *design drawings, specifications* and referenced standards.
- Reentrant*. In a *cope* or weld access hole, a cut at an abrupt change in direction in which the exposed surface is concave.
- Relative brace*. Brace that controls the relative movement of two adjacent brace points along the length of a *beam* or *column* or the relative lateral displacement of two stories in a frame (see *nodal brace*).
- Required strength*†*. *Forces, stresses* and deformations acting on a *structural component*, determined by either *structural analysis*, for the *LRFD* or *ASD load combinations*, as appropriate, or as specified by this *Specification* or Standard.
- Resistance factor ϕ †*. Factor that accounts for unavoidable deviations of the *nominal strength* from the actual strength and for the manner and consequences of failure.
- Restrained construction*. Floor and roof assemblies and individual *beams* in buildings where the surrounding or supporting structure is capable of resisting substantial thermal expansion throughout the range of anticipated *elevated temperatures*.
- Reverse curvature*. See *double curvature*.
- Root of joint*. Portion of a *joint* to be welded where the members are closest to each other.
- Rotation capacity*. Incremental angular rotation that a given shape can accept prior to excessive *load* shedding, defined as the ratio of the inelastic rotation attained to the idealized elastic rotation at first yield.
- Rupture strength†*. Strength limited by breaking or tearing of members or connecting elements.
- Safety factor; Ω †*. Factor that accounts for deviations of the actual strength from the *nominal strength*, deviations of the actual *load* from the *nominal load*, uncertainties in the analysis that transforms the load into a *load effect*, and for the manner and consequences of failure.
- Second-order effect*. Effect of *loads* acting on the deformed configuration of a structure; includes *P- δ effect* and *P- Δ effect*.
- Seismic response modification factor*. Factor that reduces seismic *load effects* to strength level.

- Service load*†. Load under which *serviceability limit states* are evaluated.
- Service load combination*. Load combination under which *serviceability limit states* are evaluated.
- Serviceability limit state*†. Limiting condition affecting the ability of a structure to preserve its appearance, maintainability, durability or the comfort of its occupants or function of machinery, under normal usage.
- Shear buckling*†. Buckling mode in which a plate element, such as the web of a *beam*, deforms under pure shear applied in the plane of the plate.
- Shear lag*. Nonuniform tensile stress distribution in a member or connecting element in the vicinity of a *connection*.
- Shear wall*†. Wall that provides resistance to *lateral loads* in the plane of the wall and provides *stability* for the *structural system*.
- Shear yielding (punching)*. In an *HSS connection*, *limit state* based on out-of-plane shear strength of the *chord wall* to which *branch members* are attached.
- Sheet steel*. In a *composite floor system*, steel used for closure plates or miscellaneous trimming in a *formed steel deck*.
- Shim*. Thin layer of material used to fill a space between faying or bearing surfaces.
- Sideways buckling (frame)*. *Stability limit state* involving lateral sideways *instability* of a frame.
- Simple connection*. *Connection* that transmits negligible bending moment between connected members.
- Single-concentrated force*. Tensile or compressive force applied normal to the flange of a member.
- Single curvature*. Deformed shape of a *beam* with no inflection point within the span.
- Slender-element section*. Cross section possessing plate components of sufficient slenderness such that *local buckling* in the elastic range will occur.
- Slip*. In a bolted *connection*, *limit state* of relative motion of connected parts prior to the attainment of the *available strength* of the connection.
- Slip-critical connection*. Bolted *connection* designed to resist movement by friction on the faying surface of the connection under the clamping force of the bolts.
- Slot weld*. Weld made in an elongated hole fusing an element to another element.
- Snug-tightened joint*. *Joint* with the connected plies in firm contact as specified in Chapter J.
- Specifications*. Written documents containing the requirements for materials, standards and workmanship.
- Specified minimum tensile strength*. Lower limit of *tensile strength* specified for a material as defined by ASTM.
- Specified minimum yield stress*†. Lower limit of *yield stress* specified for a material as defined by ASTM.
- Splice*. *Connection* between two structural elements joined at their ends to form a single, longer element.

- Stability.* Condition in the loading of a structural component, frame or structure in which a slight disturbance in the *loads* or geometry does not produce large displacements.
- Statically loaded.* Not subject to significant fatigue stresses. Gravity, wind and seismic loadings are considered to be static loadings.
- Steel anchor.* Headed stud or hot rolled channel welded to a steel member and embodied in concrete of a *composite member* to transmit shear, tension or a combination of shear and tension at the interface of the two materials.
- Stiffened element.* Flat compression element with adjoining out-of-plane elements along both edges parallel to the direction of loading.
- Stiffener.* Structural element, usually an angle or plate, attached to a member to distribute *load*, transfer shear or prevent *buckling*.
- Stiffness.* Resistance to deformation of a member or structure, measured by the ratio of the applied *force* (or moment) to the corresponding displacement (or rotation).
- Strain compatibility method.* In a *composite member*, method for determining the *stresses* considering the stress-strain relationships of each material and its location with respect to the neutral axis of the cross section.
- Strength limit state*†. Limiting condition in which the maximum strength of a structure or its components is reached.
- Stress.* Force per unit area caused by axial *force*, moment, shear or torsion.
- Stress concentration.* Localized *stress* considerably higher than average due to abrupt changes in geometry or localized loading.
- Strong axis.* Major principal centroidal axis of a cross section.
- Structural analysis*†. Determination of *load effects* on members and *connections* based on principles of structural mechanics.
- Structural component*†. Member, connector, connecting element or assemblage.
- Structural steel.* Steel elements as defined in Section 2.1 of the AISC *Code of Standard Practice for Steel Buildings and Bridges*.
- Structural system.* An assemblage of load-carrying components that are joined together to provide interaction or interdependence.
- T-connection.* *HSS connection* in which the *branch member* or connecting element is perpendicular to the *main member* and in which forces transverse to the main member are primarily equilibrated by shear in the main member.
- Tensile strength (of material)*†. Maximum tensile *stress* that a material is capable of sustaining as defined by ASTM.
- Tensile strength (of member).* Maximum tension *force* that a member is capable of sustaining.
- Tension and shear rupture*†. In a bolt or other type of mechanical *fastener*, *limit state* of rupture due to simultaneous tension and shear *force*.
- Tension field action.* Behavior of a panel under shear in which diagonal tensile forces develop in the web and compressive forces develop in the *transverse stiffeners* in a manner similar to a Pratt truss.
- Thermally cut.* Cut with gas, plasma or laser.

Tie plate. Plate element used to join two parallel components of a *built-up column*, *girder* or strut rigidly connected to the parallel components and designed to transmit shear between them.

Toe of fillet. Junction of a fillet weld face and base metal. Tangent point of a fillet in a rolled shape.

Torsional bracing. Bracing resisting twist of a *beam* or *column*.

Torsional buckling†. *Buckling* mode in which a compression member twists about its shear center axis.

Transverse reinforcement. In an *encased composite column*, steel reinforcement in the form of closed ties or welded wire fabric providing confinement for the concrete surrounding the steel shape.

Transverse stiffener. Web *stiffener* oriented perpendicular to the flanges, attached to the web.

Tubing. See *HSS*.

Turn-of-nut method. Procedure whereby the specified pretension in high-strength bolts is controlled by rotating the *fastener* component a predetermined amount after the bolt has been snug tightened.

Unbraced length. Distance between braced points of a member, measured between the centers of gravity of the bracing members.

Uneven load distribution. In an *HSS connection*, condition in which the *load* is not distributed through the cross section of connected elements in a manner that can be readily determined.

Unframed end. The end of a member not restrained against rotation by *stiffeners* or *connection elements*.

Unrestrained construction. Floor and roof assemblies and individual *beams* in buildings that are assumed to be free to rotate and expand throughout the range of anticipated *elevated temperatures*.

Unstiffened element. Flat compression element with an adjoining out-of-plane element along one edge parallel to the direction of loading.

Weak axis. Minor principal centroidal axis of a cross section.

Weathering steel. High-strength, low-alloy steel that, with suitable precautions, can be used in normal atmospheric exposures (not marine) without protective paint coating.

Web crippling†. *Limit* state of local failure of web plate in the immediate vicinity of a concentrated *load* or reaction.

Web sideways buckling. *Limit* state of lateral *buckling* of the tension flange opposite the location of a concentrated compression *force*.

Weld metal. Portion of a fusion weld that has been completely melted during welding. Weld metal has elements of filler metal and base metal melted in the weld thermal cycle.

Weld root. See *root of joint*.

Y-connection. *HSS connection* in which the *branch member* or connecting element is not perpendicular to the *main member* and in which forces transverse to the main member are primarily equilibrated by shear in the main member.

Yield moment†. In a member subjected to bending, the moment at which the extreme outer fiber first attains the *yield stress*.

Yield point†. First *stress* in a material at which an increase in strain occurs without an increase in stress as defined by ASTM.

Yield strength†. *Stress* at which a material exhibits a specified limiting deviation from the proportionality of stress to strain as defined by ASTM.

Yield stress†. Generic term to denote either *yield point* or *yield strength*, as appropriate for the material.

Yielding†. *Limit state* of inelastic deformation that occurs when the *yield stress* is reached.

Yielding (plastic moment)†. *Yielding* throughout the cross section of a member as the bending moment reaches the *plastic moment*.

Yielding (yield moment)†. *Yielding* at the extreme fiber on the cross section of a member when the bending moment reaches the *yield moment*.

CHAPTER A

GENERAL PROVISIONS

This chapter states the scope of the Specification, summarizes referenced *specifications*, codes and standards, and provides requirements for materials and structural design documents.

The chapter is organized as follows:

- A1. Scope
- A2. Referenced Specifications, Codes and Standards
- A3. Material
- A4. Structural Design Drawings and Specifications

A1. SCOPE

The *Specification for Structural Steel Buildings* (ANSI/AISC 360), hereafter referred to as the Specification, shall apply to the design of the *structural steel* system or systems with structural steel acting compositely with reinforced concrete, where the steel elements are defined in the AISC *Code of Standard Practice for Steel Buildings and Bridges*, Section 2.1, hereafter referred to as the *Code of Standard Practice*.

This Specification includes the Symbols, the Glossary, Chapters A through N, and Appendices 1 through 8. The Commentary and the User Notes interspersed throughout are not part of the Specification.

User Note: User notes are intended to provide concise and practical guidance in the application of the provisions.

This Specification sets forth criteria for the design, fabrication and erection of structural steel buildings and other structures, where other structures are defined as structures designed, fabricated and erected in a manner similar to buildings, with building-like vertical and *lateral load* resisting-elements.

Wherever this Specification refers to the *applicable building code* and there is none, the *loads*, load combinations, system limitations, and general design requirements shall be those in ASCE/SEI 7.

Where conditions are not covered by the Specification, designs are permitted to be based on tests or analysis, subject to the approval of the *authority having jurisdiction*.

Alternative methods of analysis and design are permitted, provided such alternative methods or criteria are acceptable to the authority having jurisdiction.

User Note: For the design of structural members, other than hollow structural sections (*HSS*) that are cold-formed to shapes with elements not more than 1 in. (25 mm) in thickness, the provisions of the *AISI North American Specification for the Design of Cold-Formed Steel Structural Members* are recommended.

1. Seismic Applications

The *Seismic Provisions for Structural Steel Buildings* (ANSI/AISC 341) shall apply to the design of seismic force resisting systems of *structural steel* or of structural steel acting compositely with reinforced concrete, unless specifically exempted by the *applicable building code*.

User Note: ASCE/SEI 7 (Table 12.2-1, Item H) specifically exempts structural steel systems, but not *composite* systems, in seismic design categories B and C if they are designed according to the *Specification* and the seismic loads are computed using a *seismic response modification factor*, R , of 3. For seismic design category A, ASCE/SEI 7 does specify lateral forces to be used as the seismic loads and effects, but these calculations do not involve the use of an R factor. Thus for seismic design category A it is not necessary to define a seismic force resisting system that meets any special requirements and the *Seismic Provisions for Structural Steel Buildings* do not apply.

The provisions of Appendix 1 of this Specification shall not apply to the seismic design of buildings and other structures.

2. Nuclear Applications

The design, fabrication and erection of nuclear structures shall comply with the requirements of the *Specification for Safety-Related Steel Structures for Nuclear Facilities* (ANSI/AISC N690), in addition to the provisions of this Specification.

A2. REFERENCED SPECIFICATIONS, CODES AND STANDARDS

The following *specifications*, codes and standards are referenced in this Specification:

ACI International (ACI)

ACI 318-08 *Building Code Requirements for Structural Concrete and Commentary*

ACI 318M-08 *Metric Building Code Requirements for Structural Concrete and Commentary*

ACI 349-06 *Code Requirements for Nuclear Safety-Related Concrete Structures and Commentary*

American Institute of Steel Construction (AISC)

AISC 303-10 *Code of Standard Practice for Steel Buildings and Bridges*

ANSI/AISC 341-10 *Seismic Provisions for Structural Steel Buildings*

ANSI/AISC N690-06 *Specification for Safety-Related Steel Structures for Nuclear Facilities*

American Society of Civil Engineers (ASCE)*ASCE/SEI 7-10 Minimum Design Loads for Buildings and Other Structures**ASCE/SEI/SFPE 29-05 Standard Calculation Methods for Structural Fire Protection*American Society of Mechanical Engineers (ASME)*ASME B18.2.6-06 Fasteners for Use in Structural Applications**ASME B46.1-02 Surface Texture, Surface Roughness, Waviness, and Lay*American Society for Nondestructive Testing (ASNT)*ANSI/ASNT CP-189-2006 Standard for Qualification and Certification of Nondestructive Testing Personnel**Recommended Practice No. SNT-TC-1A-2006 Personnel Qualification and Certification in Nondestructive Testing*ASTM International (ASTM)*A6/A6M-09 Standard Specification for General Requirements for Rolled Structural Steel Bars, Plates, Shapes, and Sheet Piling**A36/A36M-08 Standard Specification for Carbon Structural Steel**A53/A53M-07 Standard Specification for Pipe, Steel, Black and Hot-Dipped, Zinc-Coated, Welded and Seamless**A193/A193M-08b Standard Specification for Alloy-Steel and Stainless Steel Bolting Materials for High Temperature or High Pressure Service and Other Special Purpose Applications**A194/A194M-09 Standard Specification for Carbon and Alloy Steel Nuts for Bolts for High Pressure or High Temperature Service, or Both**A216/A216M-08 Standard Specification for Steel Castings, Carbon, Suitable for Fusion Welding, for High Temperature Service**A242/A242M-04(2009) Standard Specification for High-Strength Low-Alloy Structural Steel**A283/A283M-03(2007) Standard Specification for Low and Intermediate Tensile Strength Carbon Steel Plates**A307-07b Standard Specification for Carbon Steel Bolts and Studs, 60,000 PSI Tensile Strength**A325-09 Standard Specification for Structural Bolts, Steel, Heat Treated, 120/105 ksi Minimum Tensile Strength**A325M-09 Standard Specification for Structural Bolts, Steel, Heat Treated 830 MPa Minimum Tensile Strength (Metric)**A354-07a Standard Specification for Quenched and Tempered Alloy Steel Bolts, Studs, and Other Externally Threaded Fasteners**A370-09 Standard Test Methods and Definitions for Mechanical Testing of Steel Products**A449-07b Standard Specification for Hex Cap Screws, Bolts and Studs, Steel, Heat Treated, 120/105/90 ksi Minimum Tensile Strength, General Use**A490-08b Standard Specification for Heat-Treated Steel Structural Bolts, Alloy Steel, Heat Treated, 150 ksi Minimum Tensile Strength**A490M-08 Standard Specification for High-Strength Steel Bolts, Classes 10.9 and 10.9.3, for Structural Steel Joints (Metric)*

- A500/A500M-07 *Standard Specification for Cold-Formed Welded and Seamless Carbon Steel Structural Tubing in Rounds and Shapes*
- A501-07 *Standard Specification for Hot-Formed Welded and Seamless Carbon Steel Structural Tubing*
- A502-03 *Standard Specification for Steel Structural Rivets, Steel, Structural*
- A514/A514M-05 *Standard Specification for High-Yield Strength, Quenched and Tempered Alloy Steel Plate, Suitable for Welding*
- A529/A529M-05 *Standard Specification for High-Strength Carbon-Manganese Steel of Structural Quality*
- A563-07a *Standard Specification for Carbon and Alloy Steel Nuts*
- A563M-07 *Standard Specification for Carbon and Alloy Steel Nuts [Metric]*
- A568/A568M-09 *Standard Specification for Steel, Sheet, Carbon, Structural, and High-Strength, Low-Alloy, Hot-Rolled and Cold-Rolled, General Requirements for*
- A572/A572M-07 *Standard Specification for High-Strength Low-Alloy Columbium-Vanadium Structural Steel*
- A588/A588M-05 *Standard Specification for High-Strength Low-Alloy Structural Steel, up to 50 ksi [345 MPa] Minimum Yield Point, with Atmospheric Corrosion Resistance*
- A606/A606M-09 *Standard Specification for Steel, Sheet and Strip, High-Strength, Low-Alloy, Hot-Rolled and Cold-Rolled, with Improved Atmospheric Corrosion Resistance*
- A618/A618M-04 *Standard Specification for Hot-Formed Welded and Seamless High-Strength Low-Alloy Structural Tubing*
- A668/A668M-04 *Standard Specification for Steel Forgings, Carbon and Alloy, for General Industrial Use*
- A673/A673M-04 *Standard Specification for Sampling Procedure for Impact Testing of Structural Steel*
- A709/A709M-09 *Standard Specification for Structural Steel for Bridges*
- A751-08 *Standard Test Methods, Practices, and Terminology for Chemical Analysis of Steel Products*
- A847/A847M-05 *Standard Specification for Cold-Formed Welded and Seamless High-Strength, Low-Alloy Structural Tubing with Improved Atmospheric Corrosion Resistance*
- A852/A852M-03(2007) *Standard Specification for Quenched and Tempered Low-Alloy Structural Steel Plate with 70 ksi [485 MPa] Minimum Yield Strength to 4 in. [100 mm] Thick*
- A913/A913M-07 *Standard Specification for High-Strength Low-Alloy Steel Shapes of Structural Quality, Produced by Quenching and Self-Tempering Process (QST)*
- A992/A992M-06a *Standard Specification for Structural Steel Shapes*

User Note: ASTM A992 is the most commonly referenced specification for W-shapes.

- A1011/A1011M-09a *Standard Specification for Steel, Sheet and Strip, Hot-Rolled, Carbon, Structural, High-Strength Low-Alloy, High-Strength Low-Alloy with Improved Formability, and Ultra-High Strength*
- A1043/A1043M-05 *Standard Specification for Structural Steel with Low Yield to Tensile Ratio for Use in Buildings*

- C567-05a *Standard Test Method for Determining Density of Structural Lightweight Concrete*
- E119-08a *Standard Test Methods for Fire Tests of Building Construction and Materials*
- E165-02 *Standard Test Method for Liquid Penetrant Examination*
- E709-08 *Standard Guide for Magnetic Particle Examination*
- F436-09 *Standard Specification for Hardened Steel Washers*
- F436M-09 *Standard Specification for Hardened Steel Washers (Metric)*
- F606-07 *Standard Test Methods for Determining the Mechanical Properties of Externally and Internally Threaded Fasteners, Washers, Direct Tension Indicators, and Rivets*
- F606M-07 *Standard Test Methods for Determining the Mechanical Properties of Externally and Internally Threaded Fasteners, Washers, and Rivets (Metric)*
- F844-07a *Standard Specification for Washers, Steel, Plain (Flat), Unhardened for General Use*
- F959-09 *Standard Specification for Compressible-Washer-Type Direct Tension Indicators for Use with Structural Fasteners*
- F959M-07 *Standard Specification for Compressible-Washer-Type Direct Tension Indicators for Use with Structural Fasteners (Metric)*
- F1554-07a *Standard Specification for Anchor Bolts, Steel, 36, 55, and 105 ksi Yield Strength*

User Note: ASTM F1554 is the most commonly referenced specification for anchor rods. Grade and weldability must be specified.

- F1852-08 *Standard Specification for “Twist-Off” Type Tension Control Structural Bolt/Nut/Washer Assemblies, Steel, Heat Treated, 120/105 ksi Minimum Tensile Strength*
- F2280-08 *Standard Specification for “Twist Off” Type Tension Control Structural Bolt/Nut/Washer Assemblies, Steel, Heat Treated, 150 ksi Minimum Tensile Strength*
- American Welding Society (AWS)
- AWS A5.1/A5.1M-2004 *Specification for Carbon Steel Electrodes for Shielded Metal Arc Welding*
- AWS A5.5/A5.5M-2004 *Specification for Low-Alloy Steel Electrodes for Shielded Metal Arc Welding*
- AWS A5.17/A5.17M-1997 (R2007) *Specification for Carbon Steel Electrodes and Fluxes for Submerged Arc Welding*
- AWS A5.18/A5.18M-2005 *Specification for Carbon Steel Electrodes and Rods for Gas Shielded Arc Welding*
- AWS A5.20/A5.20M-2005 *Specification for Carbon Steel Electrodes for Flux Cored Arc Welding*
- AWS A5.23/A5.23M-2007 *Specification for Low-Alloy Steel Electrodes and Fluxes for Submerged Arc Welding*
- AWS A5.25/A5.25M-1997 (R2009) *Specification for Carbon and Low-Alloy Steel Electrodes and Fluxes for Electroslag Welding*
- AWS A5.26/A5.26M-1997 (R2009) *Specification for Carbon and Low-Alloy Steel Electrodes for Electrogas Welding*

AWS A5.28/A5.28M-2005 *Specification for Low-Alloy Steel Electrodes and Rods for Gas Shielded Arc Welding*

AWS A5.29/A5.29M-2005 *Specification for Low-Alloy Steel Electrodes for Flux Cored Arc Welding*

AWS A5.32/A5.32M-1997 (R2007) *Specification for Welding Shielding Gases*

AWS B5.1-2003 *Specification for the Qualification of Welding Inspectors*

AWS D1.1/D1.1M-2010 *Structural Welding Code—Steel*

AWS D1.3 -2008 *Structural Welding Code—Sheet Steel*

Research Council on Structural Connections (RCSC)

Specification for Structural Joints Using High-Strength Bolts, 2009

A3. MATERIAL

1. Structural Steel Materials

Material test reports or reports of tests made by the fabricator or a testing laboratory shall constitute sufficient evidence of conformity with one of the ASTM standards listed in Section A3.1a. For hot-rolled structural shapes, plates, and bars, such tests shall be made in accordance with ASTM A6/A6M; for sheets, such tests shall be made in accordance with ASTM A568/A568M; for *tubing* and *pipe*, such tests shall be made in accordance with the requirements of the applicable ASTM standards listed above for those product forms.

1a. ASTM Designations

Structural steel material conforming to one of the following ASTM *specifications* is approved for use under this Specification:

(1) Hot-rolled structural shapes

ASTM A36/A36M	ASTM A709/A709M
ASTM A529/A529M	ASTM A913/A913M
ASTM A572/A572M	ASTM A992/ A992M
ASTM A588/A588M	ASTM A1043/A1043M

(2) Structural tubing

ASTM A500	ASTM A618/A618M
ASTM A501	ASTM A847/A847M

(3) Pipe

ASTM A53/A53M, Gr. B

(4) Plates

ASTM A36/A36M	ASTM A588/A588M
ASTM A242/A242M	ASTM A709/A709M
ASTM A283/A283M	ASTM A852/A852M
ASTM A514/A514M	ASTM A1011/A1011M
ASTM A529/A529M	ASTM A1043/A1043M
ASTM A572/A572M	

(5) Bars

ASTM A36/A36M	ASTM A572/A572M
ASTM A529/A529M	ASTM A709/A709M

(6) Sheets

ASTM A606/A606M

ASTM A1011/A1011M SS, HSLAS, AND HSLAS-F

1b. Unidentified Steel

Unidentified steel, free of injurious defects, is permitted to be used only for members or details whose failure will not reduce the strength of the structure, either locally or overall. Such use shall be subject to the approval of the *engineer of record*.

User Note: Unidentified steel may be used for details where the precise mechanical properties and weldability are not of concern. These are commonly curb plates, *shims* and other similar pieces.

1c. Rolled Heavy Shapes

ASTM A6/A6M hot-rolled shapes with a flange thickness exceeding 2 in. (50 mm) are considered to be rolled heavy shapes. Rolled heavy shapes used as members subject to primary (computed) tensile *forces* due to tension or flexure and spliced or connected using *complete-joint-penetration groove welds* that fuse through the thickness of the flange or the flange and the web, shall be specified as follows. The structural design documents shall require that such shapes be supplied with *Charpy V-notch (CVN) impact test* results in accordance with ASTM A6/A6M, Supplementary Requirement S30, *Charpy V-Notch Impact Test for Structural Shapes – Alternate Core Location*. The impact test shall meet a minimum average value of 20 ft-lb (27 J) absorbed energy at a maximum temperature of +70 °F (+21 °C).

The above requirements do not apply if the *splices* and *connections* are made by bolting. Where a rolled heavy shape is welded to the surface of another shape using groove welds, the requirement above applies only to the shape that has *weld metal* fused through the cross section.

User Note: Additional requirements for joints in heavy rolled members are given in Sections J1.5, J1.6, J2.6 and M2.2.

1d. Built-Up Heavy Shapes

Built-up cross sections consisting of plates with a thickness exceeding 2 in. (50 mm) are considered built-up heavy shapes. Built-up heavy shapes used as members subject to primary (computed) tensile *forces* due to tension or flexure and spliced or connected to other members using *complete-joint-penetration groove welds* that fuse through the thickness of the plates, shall be specified as follows. The structural design documents shall require that the steel be supplied with *Charpy V-notch impact test* results in accordance with ASTM A6/A6M, Supplementary Requirement S5, *Charpy V-Notch Impact Test*. The impact test shall be conducted in accordance with ASTM A673/A673M, Frequency P, and shall meet a minimum average value of 20 ft-lb (27 J) absorbed energy at a maximum temperature of +70 °F (+21 °C).

When a built-up heavy shape is welded to the face of another member using groove welds, the requirement above applies only to the shape that has *weld metal* fused through the cross section.

User Note: Additional requirements for joints in heavy *built-up members* are given in Sections J1.5, J1.6, J2.6 and M2.2.

2. Steel Castings and Forgings

Steel castings shall conform to ASTM A216/A216M, Grade WCB with Supplementary Requirement S11. Steel forgings shall conform to ASTM A668/A668M. Test reports produced in accordance with the above reference standards shall constitute sufficient evidence of conformity with such standards.

3. Bolts, Washers and Nuts

Bolt, washer and nut material conforming to one of the following ASTM *specifications* is approved for use under this Specification:

(1) Bolts

ASTM A307	ASTM A490
ASTM A325	ASTM A490M
ASTM A325M	ASTM F1852
ASTM A354	ASTM F2280
ASTM A449	

(2) Nuts

ASTM A194/A194M	ASTM A563M
ASTM A563	

(3) Washers

ASTM F436	ASTM F844
ASTM F436M	

(4) Compressible-Washer-Type Direct Tension Indicators

ASTM F959
ASTM F959M

Manufacturer's certification shall constitute sufficient evidence of conformity with the standards.

4. Anchor Rods and Threaded Rods

Anchor rod and threaded rod material conforming to one of the following ASTM *specifications* is approved for use under this Specification:

ASTM A36/A36M	ASTM A572/A572M
ASTM A193/A193M	ASTM A588/A588M
ASTM A354	ASTM F1554
ASTM A449	

User Note: ASTM F1554 is the preferred material specification for anchor rods.

A449 material is acceptable for high-strength anchor rods and threaded rods of any diameter.

Threads on anchor rods and threaded rods shall conform to the Unified Standard Series of ASME B18.2.6 and shall have Class 2A tolerances.

Manufacturer's certification shall constitute sufficient evidence of conformity with the standards.

5. Consumables for Welding

Filler metals and fluxes shall conform to one of the following *specifications* of the American Welding Society:

AWS A5.1/A5.1M	AWS A5.25/A5.25M
AWS A5.5/A5.5M	AWS A5.26/A5.26M
AWS A5.17/A5.17M	AWS A5.28/A5.28M
AWS A5.18/A5.18M	AWS A5.29/A5.29M
AWS A5.20/A5.20M	AWS A5.32/A5.32M
AWS A5.23/A5.23M	

Manufacturer's certification shall constitute sufficient evidence of conformity with the standards. Filler metals and fluxes that are suitable for the intended application shall be selected.

6. Headed Stud Anchors

Steel headed stud anchors shall conform to the requirements of the *Structural Welding Code—Steel* (AWS D1.1/D1.1M).

Manufacturer's certification shall constitute sufficient evidence of conformity with AWS D1.1/D1.1M.

A4. STRUCTURAL DESIGN DRAWINGS AND SPECIFICATIONS

The structural *design drawings* and *specifications* shall meet the requirements in the *Code of Standard Practice*.

User Note: Provisions in this Specification contain information that is to be shown on design drawings. These include:

Section A3.1c Rolled heavy shapes where alternate core Charpy V-notch toughness (CVN) is required

Section A3.1d Built-up heavy shapes where CVN toughness is required

Section J3.1 Locations of connections using *pretensioned bolts*

Other information is needed by the fabricator or erector and should be shown on design drawings including:

Fatigue details requiring *nondestructive testing* (Appendix 3; e.g., Table A3.1, Cases 5.1 to 5.4)

Risk category (Chapter N)

Indication of complete-joint-penetration (CJP) welds subject to tension (Chapter N)

CHAPTER B

DESIGN REQUIREMENTS

This chapter addresses general requirements for the analysis and design of steel structures applicable to all chapters of the specification.

The chapter is organized as follows:

- B1. General Provisions
- B2. Loads and Load Combinations
- B3. Design Basis
- B4. Member Properties
- B5. Fabrication and Erection
- B6. Quality Control and Quality Assurance
- B7. Evaluation of Existing Structures

B1. GENERAL PROVISIONS

The design of members and *connections* shall be consistent with the intended behavior of the framing system and the assumptions made in the *structural analysis*. Unless restricted by the *applicable building code*, *lateral load* resistance and *stability* may be provided by any combination of members and connections.

B2. LOADS AND LOAD COMBINATIONS

The *loads* and load combinations shall be as stipulated by the *applicable building code*. In the absence of a building code, the loads and load combinations shall be those stipulated in *Minimum Design Loads for Buildings and Other Structures* (ASCE/SEI 7). For design purposes, the *nominal loads* shall be taken as the loads stipulated by the applicable building code.

User Note: When using ASCE/SEI 7, for design according to Section B3.3 (LRFD), the load combinations in ASCE/SEI 7, Section 2.3 apply. For design according to Section B3.4 (ASD), the load combinations in ASCE/SEI 7, Section 2.4 apply.

B3. DESIGN BASIS

Designs shall be made according to the provisions for *load and resistance factor design (LRFD)* or to the provisions for *allowable strength design (ASD)*.

1. Required Strength

The *required strength* of structural members and *connections* shall be determined by *structural analysis* for the appropriate *load* combinations as stipulated in Section B2.

Design by *elastic, inelastic* or *plastic analysis* is permitted. Provisions for inelastic and plastic analysis are as stipulated in Appendix 1, Design by Inelastic Analysis.

2. Limit States

Design shall be based on the principle that no applicable strength or *serviceability limit state* shall be exceeded when the structure is subjected to all appropriate *load combinations*.

Design for structural integrity requirements of the *applicable building code* shall be based on *nominal strength* rather than *design strength* (LRFD) or *allowable strength* (ASD), unless specifically stated otherwise in the applicable building code. Limit states for connections based on limiting deformations or *yielding* of the connection components need not be considered for meeting structural integrity requirements.

For the purpose of satisfying structural integrity provisions of the applicable building code, *bearing* bolts in connections with short-slotted holes parallel to the direction of the tension load are permitted, and shall be assumed to be located at the end of the slot.

3. Design for Strength Using Load and Resistance Factor Design (LRFD)

Design according to the provisions for *load and resistance factor design* (LRFD) satisfies the requirements of this Specification when the *design strength* of each *structural component* equals or exceeds the *required strength* determined on the basis of the *LRFD load combinations*. All provisions of this Specification, except for those in Section B3.4, shall apply.

Design shall be performed in accordance with Equation B3-1:

$$R_u \leq \phi R_n \quad (\text{B3-1})$$

where

R_u = required strength using LRFD load combinations

R_n = *nominal strength*, specified in Chapters B through K

ϕ = *resistance factor*, specified in Chapters B through K

ϕR_n = design strength

4. Design for Strength Using Allowable Strength Design (ASD)

Design according to the provisions for *allowable strength design* (ASD) satisfies the requirements of this Specification when the *allowable strength* of each *structural component* equals or exceeds the *required strength* determined on the basis of the *ASD load combinations*. All provisions of this Specification, except those of Section B3.3, shall apply.

Design shall be performed in accordance with Equation B3-2:

$$R_a \leq R_n / \Omega \quad (\text{B3-2})$$

where

R_a = required strength using ASD load combinations

R_n = *nominal strength*, specified in Chapters B through K

Ω = *safety factor*, specified in Chapters B through K

R_n / Ω = allowable strength

5. Design for Stability

Stability of the structure and its elements shall be determined in accordance with Chapter C.

6. Design of Connections

Connection elements shall be designed in accordance with the provisions of Chapters J and K. The *forces* and deformations used in design shall be consistent with the intended performance of the connection and the assumptions used in the *structural analysis*. Self-limiting inelastic deformations of the connections are permitted. At points of support, *beams*, *girders* and trusses shall be restrained against rotation about their longitudinal axis unless it can be shown by analysis that the restraint is not required.

User Note: Section 3.1.2 of the *Code of Standard Practice* addresses communication of necessary information for the design of connections.

6a. Simple Connections

A *simple connection* transmits a negligible moment. In the analysis of the structure, simple connections may be assumed to allow unrestrained relative rotation between the framing elements being connected. A simple connection shall have sufficient *rotation capacity* to accommodate the required rotation determined by the analysis of the structure.

6b. Moment Connections

Two types of moment connections, fully restrained and partially restrained, are permitted, as specified below.

(a) Fully Restrained (FR) Moment Connections

A *fully restrained (FR) moment connection* transfers moment with a negligible rotation between the connected members. In the analysis of the structure, the connection may be assumed to allow no relative rotation. An FR connection shall have sufficient strength and *stiffness* to maintain the angle between the connected members at the *strength limit states*.

(b) Partially Restrained (PR) Moment Connections

Partially restrained (PR) moment connections transfer moments, but the rotation between connected members is not negligible. In the analysis of the structure, the force-deformation response characteristics of the connection shall be included. The response characteristics of a PR connection shall be documented in the technical literature or established by analytical or experimental means. The component elements of a PR connection shall have sufficient strength, stiffness and deformation capacity at the strength limit states.

7. Moment Redistribution in Beams

The *required flexural strength of beams* composed of *compact sections*, as defined in Section B4.1, and satisfying the *unbraced length* requirements of Section F13.5

may be taken as nine-tenths of the negative moments at the points of support, produced by the *gravity loading* and determined by an *elastic analysis* satisfying the requirements of Chapter C, provided that the maximum positive moment is increased by one-tenth of the average negative moment determined by an elastic analysis. This reduction is not permitted for moments in members with F_y exceeding 65 ksi (450 MPa), for moments produced by loading on cantilevers, for design using *partially restrained (PR) moment connections*, or for design by *inelastic analysis* using the provisions of Appendix 1. This reduction is permitted for design according to Section B3.3 (LRFD) and for design according to Section B3.4 (ASD). The required axial strength shall not exceed $0.15\phi_c F_y A_g$ for LRFD or $0.15F_y A_g / \Omega_c$ for ASD where ϕ_c and Ω_c are determined from Section E1, and A_g = gross area of member, in.² (mm²), and F_y = *specified minimum yield stress*, ksi (MPa).

8. Diaphragms and Collectors

Diaphragms and *collectors* shall be designed for forces that result from *loads* as stipulated in Section B2. They shall be designed in conformance with the provisions of Chapters C through K, as applicable.

9. Design for Serviceability

The overall structure and the individual members and connections shall be checked for serviceability. Requirements for serviceability design are given in Chapter L.

10. Design for Ponding

The roof system shall be investigated through *structural analysis* to assure adequate strength and *stability* under *ponding* conditions, unless the roof surface is provided with a slope of $\frac{1}{4}$ in. per ft (20 mm per meter) or greater toward points of free drainage or an adequate system of drainage is provided to prevent the accumulation of water.

Methods of checking ponding are provided in Appendix 2, Design for Ponding.

11. Design for Fatigue

Fatigue shall be considered in accordance with Appendix 3, Design for Fatigue, for members and their *connections* subject to repeated *loading*. Fatigue need not be considered for seismic effects or for the effects of wind loading on normal building *lateral force resisting systems* and building enclosure components.

12. Design for Fire Conditions

Two methods of design for *fire* conditions are provided in Appendix 4, Structural Design for Fire Conditions: by Analysis and by Qualification Testing. Compliance with the fire protection requirements in the *applicable building code* shall be deemed to satisfy the requirements of this section and Appendix 4.

Nothing in this section is intended to create or imply a contractual requirement for the *engineer of record* responsible for the structural design or any other member of the design team.

User Note: Design by qualification testing is the prescriptive method specified in most building codes. Traditionally, on most projects where the architect is the prime professional, the architect has been the responsible party to specify and coordinate fire protection requirements. Design by analysis is a new engineering approach to fire protection. Designation of the person(s) responsible for designing for fire conditions is a contractual matter to be addressed on each project.

13. Design for Corrosion Effects

Where corrosion may impair the strength or serviceability of a structure, *structural components* shall be designed to tolerate corrosion or shall be protected against corrosion.

14. Anchorage to Concrete

Anchorage between steel and concrete acting compositely shall be designed in accordance with Chapter I. The design of *column bases* and anchor rods shall be in accordance with Chapter J.

B4. MEMBER PROPERTIES

1. Classification of Sections for Local Buckling

For compression, sections are classified as nonslender element or *slender-element sections*. For a nonslender element section, the width-to-thickness ratios of its compression elements shall not exceed λ_r from Table B4.1a. If the width-to-thickness ratio of any compression element exceeds λ_r , the section is a slender-element section.

For flexure, sections are classified as *compact*, *noncompact* or slender-element sections. For a section to qualify as compact, its flanges must be continuously connected to the web or webs and the width-to-thickness ratios of its compression elements shall not exceed the limiting width-to-thickness ratios, λ_p , from Table B4.1b. If the width-to-thickness ratio of one or more compression elements exceeds λ_p , but does not exceed λ_r from Table B4.1b, the section is noncompact. If the width-to-thickness ratio of any compression element exceeds λ_r , the section is a slender-element section.

1a. Unstiffened Elements

For *unstiffened elements* supported along only one edge parallel to the direction of the compression *force*, the width shall be taken as follows:

- (a) For flanges of I-shaped members and tees, the width, b , is one-half the full-flange width, b_f .
- (b) For legs of angles and flanges of channels and zees, the width, b , is the full *nominal dimension*.
- (c) For plates, the width, b , is the distance from the free edge to the first row of *fasteners* or line of welds.
- (d) For stems of tees, d is taken as the full nominal depth of the section.

User Note: Refer to Table B4.1 for the graphic representation of unstiffened element dimensions.

1b. Stiffened Elements

For *stiffened elements* supported along two edges parallel to the direction of the compression *force*, the width shall be taken as follows:

- (a) For webs of rolled or *formed sections*, h is the clear distance between flanges less the fillet or corner radius at each flange; h_c is twice the distance from the center of gravity to the inside face of the compression flange less the fillet or corner radius.
- (b) For webs of *built-up sections*, h is the distance between adjacent lines of *fasteners* or the clear distance between flanges when welds are used, and h_c is twice the distance from the center of gravity to the nearest line of fasteners at the compression flange or the inside face of the compression flange when welds are used; h_p is twice the distance from the plastic neutral axis to the nearest line of fasteners at the compression flange or the inside face of the compression flange when welds are used.
- (c) For flange or *diaphragm plates* in built-up sections, the width, b , is the distance between adjacent lines of fasteners or lines of welds.
- (d) For flanges of rectangular hollow structural sections (*HSS*), the width, b , is the clear distance between webs less the inside corner radius on each side. For webs of rectangular HSS, h is the clear distance between the flanges less the inside corner radius on each side. If the corner radius is not known, b and h shall be taken as the corresponding outside dimension minus three times the thickness. The thickness, t , shall be taken as the *design wall thickness*, per Section B4.2.
- (e) For perforated *cover plates*, b is the transverse distance between the nearest line of fasteners, and the *net area* of the plate is taken at the widest hole.

User Note: Refer to Table B4.1 for the graphic representation of stiffened element dimensions.

For tapered flanges of rolled sections, the thickness is the nominal value halfway between the free edge and the corresponding face of the web.

2. Design Wall Thickness for HSS

The *design wall thickness*, t , shall be used in calculations involving the wall thickness of hollow structural sections (*HSS*). The design wall thickness, t , shall be taken equal to 0.93 times the nominal wall thickness for electric-resistance-welded (ERW) HSS and equal to the nominal thickness for submerged-arc-welded (SAW) HSS.

TABLE B4.1a
Width-to-Thickness Ratios: Compression Elements
Members Subject to Axial Compression







Case	Description of Element	Width-to-Thickness Ratio	Limiting Width-to-Thickness Ratio λ_r (nonslender/slender)	Examples	
Unstiffened Elements	1	Flanges of rolled I-shaped sections, plates projecting from rolled I-shaped sections; outstanding legs of pairs of angles connected with continuous contact, flanges of channels, and flanges of tees	b/t	$0.56 \sqrt{\frac{E}{F_y}}$	
	2	Flanges of built-up I-shaped sections and plates or angle legs projecting from built-up I-shaped sections	b/t	$0.64 \sqrt{\frac{k_c E}{F_y}}$ ^[a]	
	3	Legs of single angles, legs of double angles with separators, and all other unstiffened elements	b/t	$0.45 \sqrt{\frac{E}{F_y}}$	
	4	Stems of tees	d/t	$0.75 \sqrt{\frac{E}{F_y}}$	
Stiffened Elements	5	Webs of doubly-symmetric I-shaped sections and channels	h/t_w	$1.49 \sqrt{\frac{E}{F_y}}$	
	6	Walls of rectangular HSS and boxes of uniform thickness	b/t	$1.40 \sqrt{\frac{E}{F_y}}$	
	7	Flange cover plates and diaphragm plates between lines of fasteners or welds	b/t	$1.40 \sqrt{\frac{E}{F_y}}$	
	8	All other stiffened elements	b/t	$1.49 \sqrt{\frac{E}{F_y}}$	
	9	Round HSS	D/t	$0.11 \frac{E}{F_y}$	

TABLE B4.1b
Width-to-Thickness Ratios: Compression Elements
Members Subject to Flexure

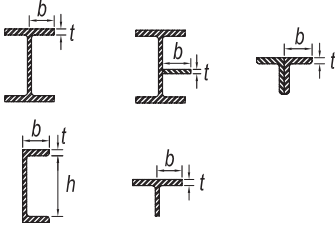
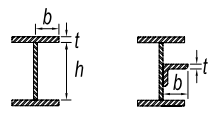
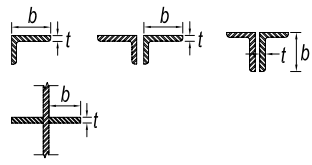
Case	Description of Element	Width-to-Thickness Ratio	Limiting Width-to-Thickness Ratio		Examples
			λ_p (compact/ noncompact)	λ_r (noncompact/ slender)	
Unstiffened Elements	10 Flanges of rolled I-shaped sections, channels, and tees	b/t	$0.38\sqrt{\frac{E}{F_y}}$	$1.0\sqrt{\frac{E}{F_y}}$	
	11 Flanges of doubly and singly symmetric I-shaped built-up sections	b/t	$0.38\sqrt{\frac{E}{F_y}}$	$0.95\sqrt{\frac{k_c E}{F_L}}$ [a] [b]	
	12 Legs of single angles	b/t	$0.54\sqrt{\frac{E}{F_y}}$	$0.91\sqrt{\frac{E}{F_y}}$	
	13 Flanges of all I-shaped sections and channels in flexure about the weak axis	b/t	$0.38\sqrt{\frac{E}{F_y}}$	$1.0\sqrt{\frac{E}{F_y}}$	
	14 Stems of tees	d/t	$0.84\sqrt{\frac{E}{F_y}}$	$1.03\sqrt{\frac{E}{F_y}}$	
Stiffened Elements	15 Webs of doubly-symmetric I-shaped sections and channels	h/t_w	$3.76\sqrt{\frac{E}{F_y}}$	$5.70\sqrt{\frac{E}{F_y}}$	
	16 Webs of singly-symmetric I-shaped sections	h_c/t_w	$\frac{h_c}{h_o}\sqrt{\frac{E}{F_y}}$ [c] $\left(\frac{0.54 M_p}{M_y} - 0.09\right) \leq \lambda_r$	$5.70\sqrt{\frac{E}{F_y}}$	
	17 Flanges of rectangular HSS and boxes of uniform thickness	b/t	$1.12\sqrt{\frac{E}{F_y}}$	$1.40\sqrt{\frac{E}{F_y}}$	
	18 Flange cover plates and diaphragm plates between lines of fasteners or welds	b/t	$1.12\sqrt{\frac{E}{F_y}}$	$1.40\sqrt{\frac{E}{F_y}}$	
	19 Webs of rectangular HSS and boxes	h/t	$2.42\sqrt{\frac{E}{F_y}}$	$5.70\sqrt{\frac{E}{F_y}}$	
20 Round HSS	D/t	$0.07\frac{E}{F_y}$	$0.31\frac{E}{F_y}$		

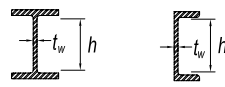
[a] $k_c = 4\sqrt{h/t_w}$ but shall not be taken less than 0.35 nor greater than 0.76 for calculation purposes.
 [b] $F_L = 0.7F_y$ for major axis bending of compact and noncompact web built-up I-shaped members with $S_{xt}/S_{xc} \geq 0.7$;
 $F_L = F_y S_{xt}/S_{xc} \geq 0.5F_y$ for major-axis bending of compact and noncompact web built-up I-shaped members with $S_{xt}/S_{xc} < 0.7$.
 [c] M_p is the moment at yielding of the extreme fiber. M_y = plastic bending moment, kip-in. (N-mm)
 E = modulus of elasticity of steel = 29,000 ksi (200 000 MPa)
 F_y = specified minimum yield stress, ksi (MPa)

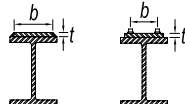
User Note: A *pipe* can be designed using the provisions of the Specification for round HSS sections as long as the pipe conforms to ASTM A53 Class B and the appropriate limitations of the Specification are used.

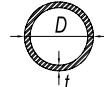
ASTM A500 HSS and ASTM A53 Grade B pipe are produced by an ERW process. An SAW process is used for cross sections that are larger than those permitted by ASTM A500.

3. Gross and Net Area Determination

3a. Gross Area

The gross area, A_g , of a member is the total cross-sectional area.

3b. Net Area

The *net area*, A_n , of a member is the sum of the products of the thickness and the net width of each element computed as follows:

In computing net area for tension and shear, the width of a bolt hole shall be taken as $1/16$ in. (2 mm) greater than the *nominal dimension* of the hole.

For a chain of holes extending across a part in any diagonal or zigzag line, the net width of the part shall be obtained by deducting from the gross width the sum of the diameters or slot dimensions as provided in this section, of all holes in the chain, and adding, for each *gage space* in the chain, the quantity $s^2/4g$,

where

s = longitudinal center-to-center spacing (*pitch*) of any two consecutive holes, in. (mm)

g = transverse center-to-center spacing (*gage*) between *fastener gage lines*, in. (mm)

For angles, the *gage* for holes in opposite adjacent legs shall be the sum of the gages from the back of the angles less the thickness.

For slotted HSS welded to a *gusset plate*, the net area, A_n , is the gross area minus the product of the thickness and the total width of material that is removed to form the slot.

In determining the net area across plug or *slot welds*, the *weld metal* shall not be considered as adding to the net area.

For members without holes, the net area, A_n , is equal to the gross area, A_g .

User Note: Section J4.1(b) limits A_n to a maximum of $0.85A_g$ for *splice plates* with holes.

B5. FABRICATION AND ERECTION

Shop drawings, fabrication, shop painting and erection shall satisfy the requirements stipulated in Chapter M, Fabrication and Erection.

B6. QUALITY CONTROL AND QUALITY ASSURANCE

Quality control and *quality assurance* activities shall satisfy the requirements stipulated in Chapter N, Quality Control and Quality Assurance.

B7. EVALUATION OF EXISTING STRUCTURES

The evaluation of existing structures shall satisfy the requirements stipulated in Appendix 5, Evaluation of Existing Structures.

CHAPTER C

DESIGN FOR STABILITY

This chapter addresses requirements for the design of structures for *stability*. The *direct analysis method* is presented herein; alternative methods are presented in Appendix 7.

The chapter is organized as follows:

- C1. General Stability Requirements
- C2. Calculation of Required Strengths
- C3. Calculation of Available Strengths

C1. GENERAL STABILITY REQUIREMENTS

Stability shall be provided for the structure as a whole and for each of its elements. The effects of all of the following on the stability of the structure and its elements shall be considered: (1) flexural, shear and axial member deformations, and all other deformations that contribute to displacements of the structure; (2) *second-order effects* (both P - Δ and P - δ effects); (3) geometric imperfections; (4) *stiffness reductions* due to inelasticity; and (5) uncertainty in stiffness and strength. All *load-dependent effects* shall be calculated at a level of loading corresponding to *LRFD load combinations* or 1.6 times *ASD load combinations*.

Any rational method of design for stability that considers all of the listed effects is permitted; this includes the methods identified in Sections C1.1 and C1.2.

For structures designed by *inelastic analysis*, the provisions of Appendix 1 shall be satisfied.

User Note: The term “design” as used in these provisions is the combination of analysis to determine the *required strengths* of components and the proportioning of components to have adequate *available strength*.

See Commentary Section C1 and Table C-C1.1 for explanation of how requirements (1) through (5) of Section C1 are satisfied in the methods of design listed in Sections C1.1 and C1.2.

1. Direct Analysis Method of Design

The *direct analysis method* of design, which consists of the calculation of *required strengths* in accordance with Section C2 and the calculation of *available strengths* in accordance with Section C3, is permitted for all structures.

2. Alternative Methods of Design

The *effective length* method and the *first-order analysis* method, defined in Appendix 7, are permitted as alternatives to the *direct analysis method* for structures that satisfy the constraints specified in that appendix.

C2. CALCULATION OF REQUIRED STRENGTHS

For the *direct analysis method* of design, the *required strengths* of components of the structure shall be determined from an analysis conforming to Section C2.1. The analysis shall include consideration of initial imperfections in accordance with Section C2.2 and adjustments to *stiffness* in accordance with Section C2.3.

1. General Analysis Requirements

The analysis of the structure shall conform to the following requirements:

- (1) The analysis shall consider flexural, shear and axial member deformations, and all other component and *connection* deformations that contribute to displacements of the structure. The analysis shall incorporate reductions in all *stiffnesses* that are considered to contribute to the *stability* of the structure, as specified in Section C2.3.
- (2) The analysis shall be a *second-order analysis* that considers both P - Δ and P - δ effects, except that it is permissible to neglect the effect of P - δ on the response of the structure when the following conditions are satisfied: (a) The structure supports *gravity loads* primarily through nominally-vertical *columns*, walls or frames; (b) the ratio of maximum second-order *drift* to maximum first-order drift (both determined for *LRFD load combinations* or 1.6 times *ASD load combinations*, with stiffnesses adjusted as specified in Section C2.3) in all stories is equal to or less than 1.7; and (c) no more than one-third of the total gravity load on the structure is supported by columns that are part of moment-resisting frames in the direction of translation being considered. It is necessary in all cases to consider P - δ effects in the evaluation of individual members subject to compression and flexure.

User Note: A P - Δ -only second-order analysis (one that neglects the effects of P - δ on the response of the structure) is permitted under the conditions listed. The requirement for considering P - δ effects in the evaluation of individual members can be satisfied by applying the B_1 multiplier defined in Appendix 8.

Use of the approximate method of second-order analysis provided in Appendix 8 is permitted as an alternative to a rigorous second-order analysis.

- (3) The analysis shall consider all gravity and other applied *loads* that may influence the stability of the structure.

User Note: It is important to include in the analysis all gravity loads, including loads on *leaning columns* and other elements that are not part of the *lateral force resisting system*.

- (4) For design by *LRFD*, the second-order analysis shall be carried out under LRFD load combinations. For design by *ASD*, the second-order analysis shall be carried out under 1.6 times the ASD load combinations, and the results shall be divided by 1.6 to obtain the *required strengths* of components.

2. Consideration of Initial Imperfections

The effect of initial imperfections on the *stability* of the structure shall be taken into account either by direct modeling of imperfections in the analysis as specified in Section C2.2a or by the application of *notional loads* as specified in Section C2.2b.

User Note: The imperfections considered in this section are imperfections in the locations of points of intersection of members. In typical building structures, the important imperfection of this type is the out-of-plumbness of *columns*. Initial out-of-straightness of individual members is not addressed in this section; it is accounted for in the compression member design provisions of Chapter E and need not be considered explicitly in the analysis as long as it is within the limits specified in the AISC *Code of Standard Practice*.

2a. Direct Modeling of Imperfections

In all cases, it is permissible to account for the effect of initial imperfections by including the imperfections directly in the analysis. The structure shall be analyzed with points of intersection of members displaced from their nominal locations. The magnitude of the initial displacements shall be the maximum amount considered in the design; the pattern of initial displacements shall be such that it provides the greatest destabilizing effect.

User Note: Initial displacements similar in configuration to both displacements due to loading and anticipated *buckling* modes should be considered in the modeling of imperfections. The magnitude of the initial displacements should be based on permissible construction tolerances, as specified in the AISC *Code of Standard Practice* or other governing requirements, or on actual imperfections if known.

In the analysis of structures that support *gravity loads* primarily through nominally-vertical *columns*, walls or frames, where the ratio of maximum second-order *drift* to maximum first-order drift (both determined for *LRFD load combinations* or 1.6 times *ASD load combinations*, with *stiffnesses* adjusted as specified in Section C2.3) in all stories is equal to or less than 1.7, it is permissible to include initial imperfections only in the analysis for gravity-only load combinations and not in the analysis for load combinations that include applied *lateral loads*.

2b. Use of Notional Loads to Represent Imperfections

For structures that support *gravity loads* primarily through nominally-vertical *columns*, walls or frames, it is permissible to use *notional loads* to represent the effects of initial imperfections in accordance with the requirements of this section. The notional load shall be applied to a model of the structure based on its nominal geometry.

User Note: The notional load concept is applicable to all types of structures, but the specific requirements in Sections C2.2b(1) through C2.2b(4) are applicable only for the particular class of structure identified above.

- (1) Notional loads shall be applied as *lateral loads* at all levels. The notional loads shall be additive to other lateral loads and shall be applied in all load combinations, except as indicated in (4), below. The magnitude of the notional loads shall be:

$$N_i = 0.002\alpha Y_i \quad (\text{C2-1})$$

where

$\alpha = 1.0$ (LRFD); $\alpha = 1.6$ (ASD)

N_i = notional load applied at level i , kips (N)

Y_i = gravity load applied at level i from the *LRFD load combination* or *ASD load combination*, as applicable, kips (N)

User Note: The notional loads can lead to additional (generally small) fictitious base shears in the structure. The correct horizontal reactions at the foundation may be obtained by applying an additional horizontal force at the base of the structure, equal and opposite in direction to the sum of all notional loads, distributed among vertical load-carrying elements in the same proportion as the gravity load supported by those elements. The notional loads can also lead to additional overturning effects, which are not fictitious.

- (2) The notional load at any level, N_i , shall be distributed over that level in the same manner as the gravity load at the level. The notional loads shall be applied in the direction that provides the greatest destabilizing effect.

User Note: For most building structures, the requirement regarding notional load direction may be satisfied as follows: For load combinations that do not include lateral loading, consider two alternative orthogonal directions of notional load application, in a positive and a negative sense in each of the two directions, in the same direction at all levels; for load combinations that include lateral loading, apply all notional loads in the direction of the resultant of all lateral loads in the combination.

- (3) The notional load coefficient of 0.002 in Equation C2-1 is based on a nominal initial story out-of-plumbness ratio of 1/500; where the use of a different maximum out-of-plumbness is justified, it is permissible to adjust the notional load coefficient proportionally.

User Note: An out-of-plumbness of 1/500 represents the maximum tolerance on column plumbness specified in the AISC *Code of Standard Practice*. In some cases, other specified tolerances such as those on plan location of columns will govern and will require a tighter plumbness tolerance.

- (4) For structures in which the ratio of maximum second-order *drift* to maximum first-order drift (both determined for LRFD load combinations or 1.6 times ASD load combinations, with stiffnesses adjusted as specified in Section C2.3) in all stories is equal to or less than 1.7, it is permissible to apply the notional load, N_i ,

only in gravity-only load combinations and not in combinations that include other lateral loads.

3. Adjustments to Stiffness

The analysis of the structure to determine the *required strengths* of components shall use reduced *stiffnesses*, as follows:

- (1) A factor of 0.80 shall be applied to all stiffnesses that are considered to contribute to the *stability* of the structure. It is permissible to apply this reduction factor to all stiffnesses in the structure.

User Note: Applying the stiffness reduction to some members and not others can, in some cases, result in artificial distortion of the structure under *load* and possible unintended redistribution of forces. This can be avoided by applying the reduction to all members, including those that do not contribute to the stability of the structure.

- (2) An additional factor, τ_b , shall be applied to the flexural stiffnesses of all members whose flexural stiffnesses are considered to contribute to the stability of the structure.

- (a) When $\alpha P_r/P_y \leq 0.5$

$$\tau_b = 1.0 \quad (\text{C2-2a})$$

- (b) When $\alpha P_r/P_y > 0.5$

$$\tau_b = 4(\alpha P_r/P_y)[1 - (\alpha P_r/P_y)] \quad (\text{C2-2b})$$

where

$\alpha = 1.0$ (LRFD); $\alpha = 1.6$ (ASD)

P_r = required axial compressive strength using *LRFD* or *ASD load combinations*, kips (N)

P_y = axial *yield strength* ($= F_y A_g$), kips (N)

User Note: Taken together, sections (1) and (2) require the use of $0.8\tau_b$ times the nominal elastic flexural stiffness and 0.8 times other nominal elastic stiffnesses for *structural steel* members in the analysis.

- (3) In structures to which Section C2.2b is applicable, in lieu of using $\tau_b < 1.0$ where $\alpha P_r/P_y > 0.5$, it is permissible to use $\tau_b = 1.0$ for all members if a *notional load* of $0.001\alpha Y_i$ [where Y_i is as defined in Section C2.2b(1)] is applied at all levels, in the direction specified in Section C2.2b(2), in all load combinations. These notional loads shall be added to those, if any, used to account for imperfections and shall not be subject to Section C2.2b(4).
- (4) Where components comprised of materials other than structural steel are considered to contribute to the stability of the structure and the governing codes and *specifications* for the other materials require greater reductions in stiffness, such greater stiffness reductions shall be applied to those components.

C3. CALCULATION OF AVAILABLE STRENGTHS

For the *direct analysis method* of design, the *available strengths* of members and connections shall be calculated in accordance with the provisions of Chapters D, E, F, G, H, I, J and K, as applicable, with no further consideration of overall structure *stability*. The *effective length factor*, K , of all members shall be taken as unity unless a smaller value can be justified by rational analysis.

Bracing intended to define the *unbraced lengths* of members shall have sufficient *stiffness* and strength to control member movement at the braced points.

Methods of satisfying bracing requirements for individual columns, beams and beam-columns are provided in Appendix 6. The requirements of Appendix 6 are not applicable to bracing that is included as part of the overall force-resisting system.

CHAPTER D

DESIGN OF MEMBERS FOR TENSION

This chapter applies to members subject to axial tension caused by static *forces* acting through the centroidal axis.

The chapter is organized as follows:

- D1. Slenderness Limitations
- D2. Tensile Strength
- D3. Effective Net Area
- D4. Built-Up Members
- D5. Pin-Connected Members
- D6. Eyebars

User Note: For cases not included in this chapter the following sections apply:

- B3.11 Members subject to *fatigue*
- Chapter H Members subject to combined axial tension and flexure
- J3 Threaded rods
- J4.1 Connecting elements in tension
- J4.3 *Block shear rupture* strength at end connections of tension members

D1. SLENDERNESS LIMITATIONS

There is no maximum slenderness limit for members in tension.

User Note: For members designed on the basis of tension, the slenderness ratio L/r preferably should not exceed 300. This suggestion does not apply to rods or hangers in tension.

D2. TENSILE STRENGTH

The *design tensile strength*, $\phi_t P_n$, and the *allowable tensile strength*, P_n/Ω_t , of tension members shall be the lower value obtained according to the *limit states of tensile yielding* in the gross section and *tensile rupture* in the net section.

(a) For tensile yielding in the gross section:

$$P_n = F_y A_g \quad (D2-1)$$

$$\phi_t = 0.90 \text{ (LRFD)} \quad \Omega_t = 1.67 \text{ (ASD)}$$

(b) For tensile rupture in the net section:

$$P_n = F_u A_e \quad (D2-2)$$

$$\phi_t = 0.75 \text{ (LRFD)} \quad \Omega_t = 2.00 \text{ (ASD)}$$

where

A_e = effective net area, in.² (mm²)

A_g = gross area of member, in.² (mm²)

F_y = specified minimum yield stress, ksi (MPa)

F_u = specified minimum tensile strength, ksi (MPa)

When members without holes are fully connected by welds, the effective net area used in Equation D2-2 shall be as defined in Section D3. When holes are present in a member with welded end *connections*, or at the welded connection in the case of plug or *slot welds*, the effective net area through the holes shall be used in Equation D2-2.

D3. EFFECTIVE NET AREA

The gross area, A_g , and *net area*, A_n , of tension members shall be determined in accordance with the provisions of Section B4.3.

The *effective net area* of tension members shall be determined as follows:

$$A_e = A_n U \quad (D3-1)$$

where U , the *shear lag* factor, is determined as shown in Table D3.1.

For open cross sections such as W, M, S, C or HP shapes, WTs, STs, and single and double angles, the shear lag factor, U , need not be less than the ratio of the gross area of the connected element(s) to the member gross area. This provision does not apply to closed sections, such as *HSS* sections, nor to plates.

User Note: For bolted *splice* plates $A_e = A_n \leq 0.85A_g$, according to Section J4.1.

D4. BUILT-UP MEMBERS

For limitations on the longitudinal spacing of connectors between elements in continuous contact consisting of a plate and a shape or two plates, see Section J3.5.

Either perforated *cover plates* or *tie plates* without *lacing* are permitted to be used on the open sides of built-up tension members. Tie plates shall have a length not less than two-thirds the distance between the lines of welds or *fasteners* connecting them to the components of the member. The thickness of such tie plates shall not be less than one-fiftieth of the distance between these lines. The longitudinal spacing of intermittent welds or fasteners at tie plates shall not exceed 6 in. (150 mm).

User Note: The longitudinal spacing of connectors between components should preferably limit the slenderness ratio in any component between the connectors to 300.

TABLE D3.1
Shear Lag Factors for Connections
to Tension Members

Case	Description of Element		Shear Lag Factor, U	Example
1	All tension members where the tension load is transmitted directly to each of the cross-sectional elements by fasteners or welds (except as in Cases 4, 5 and 6).		$U = 1.0$	
2	All tension members, except plates and HSS, where the tension load is transmitted to some but not all of the cross-sectional elements by fasteners or longitudinal welds or by longitudinal welds in combination with transverse welds. (Alternatively, for W, M, S and HP, Case 7 may be used. For angles, Case 8 may be used.)		$U = 1 - \bar{x}/l$	
3	All tension members where the tension load is transmitted only by transverse welds to some but not all of the cross-sectional elements.		$U = 1.0$ and $A_n =$ area of the directly connected elements	
4	Plates where the tension load is transmitted by longitudinal welds only.		$l \geq 2w \dots U = 1.0$ $2w > l \geq 1.5w \dots U = 0.87$ $1.5w > l \geq w \dots U = 0.75$	
5	Round HSS with a single concentric gusset plate		$l \geq 1.3D \dots U = 1.0$ $D \leq l < 1.3D \dots U = 1 - \bar{x}/l$ $\bar{x} = D/\pi$	
6	Rectangular HSS	with a single concentric gusset plate	$l \geq H \dots U = 1 - \bar{x}/l$ $\bar{x} = \frac{B^2 + 2BH}{4(B+H)}$	
		with two side gusset plates	$l \geq H \dots U = 1 - \bar{x}/l$ $\bar{x} = \frac{B^2}{4(B+H)}$	
7	W, M, S or HP Shapes or Tees cut from these shapes. (If U is calculated per Case 2, the larger value is permitted to be used.)	with flange connected with 3 or more fasteners per line in the direction of loading	$b_f \geq 2/3d \dots U = 0.90$ $b_f < 2/3d \dots U = 0.85$	
		with web connected with 4 or more fasteners per line in the direction of loading	$U = 0.70$	
8	Single and double angles (If U is calculated per Case 2, the larger value is permitted to be used.)	with 4 or more fasteners per line in the direction of loading	$U = 0.80$	
		with 3 fasteners per line in the direction of loading (With fewer than 3 fasteners per line in the direction of loading, use Case 2.)	$U = 0.60$	

l = length of connection, in. (mm); w = plate width, in. (mm); \bar{x} = eccentricity of connection, in. (mm); B = overall width of rectangular HSS member, measured 90° to the plane of the connection, in. (mm); H = overall height of rectangular HSS member, measured in the plane of the connection, in. (mm)

D5. PIN-CONNECTED MEMBERS

1. Tensile Strength

The *design tensile strength*, $\phi_t P_n$, and the *allowable tensile strength*, P_n/Ω_t , of pin-connected members, shall be the lower value determined according to the *limit states of tensile rupture, shear rupture, bearing and yielding*.

(a) For tensile rupture on the net effective area:

$$P_n = F_u (2tb_e) \quad (D5-1)$$

$$\phi_t = 0.75 \text{ (LRFD)} \quad \Omega_t = 2.00 \text{ (ASD)}$$

(b) For shear rupture on the effective area:

$$P_n = 0.6F_u A_{sf} \quad (D5-2)$$

$$\phi_{sf} = 0.75 \text{ (LRFD)} \quad \Omega_{sf} = 2.00 \text{ (ASD)}$$

where

A_{sf} = area on the shear failure path = $2t(a + d / 2)$, in.² (mm²)

a = shortest distance from edge of the pin hole to the edge of the member measured parallel to the direction of the *force*, in. (mm)

$b_e = 2t + 0.63$, in. (= $2t + 16$, mm), but not more than the actual distance from the edge of the hole to the edge of the part measured in the direction normal to the applied force, in. (mm)

d = diameter of pin, in. (mm)

t = thickness of plate, in. (mm)

(c) For bearing on the projected area of the pin, use Section J7.

(d) For yielding on the gross section, use Section D2(a).

2. Dimensional Requirements

The pin hole shall be located midway between the edges of the member in the direction normal to the applied *force*. When the pin is expected to provide for relative movement between connected parts while under full *load*, the diameter of the pin hole shall not be more than $1/32$ in. (1 mm) greater than the diameter of the pin.

The width of the plate at the pin hole shall not be less than $2b_e + d$ and the minimum extension, a , beyond the *bearing* end of the pin hole, parallel to the axis of the member, shall not be less than $1.33b_e$.

The corners beyond the pin hole are permitted to be cut at 45° to the axis of the member, provided the *net area* beyond the pin hole, on a plane perpendicular to the cut, is not less than that required beyond the pin hole parallel to the axis of the member.

D6. EYEBARS

1. Tensile Strength

The *available tensile strength* of *eyebars* shall be determined in accordance with Section D2, with A_g taken as the cross-sectional area of the body.

For calculation purposes, the width of the body of the eyebars shall not exceed eight times its thickness.

2. Dimensional Requirements

Eyebars shall be of uniform thickness, without reinforcement at the pin holes, and have circular heads with the periphery concentric with the pin hole.

The radius of transition between the circular head and the eyebar body shall not be less than the head diameter.

The pin diameter shall not be less than seven-eighths times the eyebar body width, and the pin hole diameter shall not be more than $1/32$ in. (1 mm) greater than the pin diameter.

For steels having F_y greater than 70 ksi (485 MPa), the hole diameter shall not exceed five times the plate thickness, and the width of the eyebar body shall be reduced accordingly.

A thickness of less than $1/2$ in. (13 mm) is permissible only if external nuts are provided to tighten pin plates and *filler* plates into snug contact. The width from the hole edge to the plate edge perpendicular to the direction of applied *load* shall be greater than two-thirds and, for the purpose of calculation, not more than three-fourths times the eyebar body width.

CHAPTER E

DESIGN OF MEMBERS FOR COMPRESSION

This chapter addresses members subject to axial compression through the centroidal axis.

The chapter is organized as follows:

- E1. General Provisions
- E2. Effective Length
- E3. Flexural Buckling of Members without Slender Elements
- E4. Torsional and Flexural-Torsional Buckling of Members without Slender Elements
- E5. Single Angle Compression Members
- E6. Built-Up Members
- E7. Members with Slender Elements

User Note: For cases not included in this chapter the following sections apply:

- H1 – H2 Members subject to combined axial compression and flexure
- H3 Members subject to axial compression and torsion
- I2 Composite axially loaded members
- J4.4 Compressive strength of connecting elements







E1. GENERAL PROVISIONS

The *design compressive strength*, $\phi_c P_n$, and the *allowable compressive strength*, P_n/Ω_c , are determined as follows.

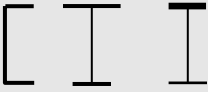
The *nominal compressive strength*, P_n , shall be the lowest value obtained based on the applicable *limit states* of *flexural buckling*, *torsional buckling*, and *flexural-torsional buckling*.

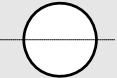
$$\phi_c = 0.90 \text{ (LRFD)} \quad \Omega_c = 1.67 \text{ (ASD)}$$

TABLE USER NOTE E1.1
Selection Table for the Application of
Chapter E Sections

Cross Section	Without Slender Elements		With Slender Elements	
	Sections in Chapter E	Limit States	Sections in Chapter E	Limit States
	E3 E4	FB TB	E7	LB FB TB
	E3 E4	FB FTB	E7	LB FB FTB
	E3	FB	E7	LB FB
	E3	FB	E7	LB FB
	E3 E4	FB FTB	E7	LB FB FTB
	E6 E3 E4	FB FTB	E6 E7	LB FB FTB
	E5		E5	
	E3	FB	N/A	N/A
Unsymmetrical shapes other than single angles	E4	FTB	E7	LB FTB

FB = flexural buckling, TB = torsional buckling, FTB = flexural-torsional buckling, LB = local buckling

E2. EFFECTIVE LENGTH

The *effective length factor*, K , for calculation of member slenderness, KL/r ; shall be determined in accordance with Chapter C or Appendix 7,

where

L = laterally *unbraced length* of the member, in. (mm)

r = radius of gyration, in. (mm)

User Note: For members designed on the basis of compression, the effective slenderness ratio KL/r preferably should not exceed 200.

E3. FLEXURAL BUCKLING OF MEMBERS WITHOUT SLENDER ELEMENTS

This section applies to nonslender element compression members as defined in Section B4.1 for elements in uniform compression.

User Note: When the torsional *unbraced length* is larger than the lateral unbraced length, Section E4 may control the design of wide flange and similarly shaped columns.

The *nominal compressive strength*, P_n , shall be determined based on the *limit state of flexural buckling*.

$$P_n = F_{cr} A_g \quad (\text{E3-1})$$

The *critical stress*, F_{cr} , is determined as follows:

$$(a) \text{ When } \frac{KL}{r} \leq 4.71 \sqrt{\frac{E}{F_y}} \quad \left(\text{or } \frac{F_y}{F_e} \leq 2.25 \right)$$

$$F_{cr} = \left[0.658 \frac{F_y}{F_e} \right] F_y \quad (\text{E3-2})$$

$$(b) \text{ When } \frac{KL}{r} > 4.71 \sqrt{\frac{E}{F_y}} \quad \left(\text{or } \frac{F_y}{F_e} > 2.25 \right)$$

$$F_{cr} = 0.877 F_e \quad (\text{E3-3})$$

where

F_e = elastic *buckling stress* determined according to Equation E3-4, as specified in Appendix 7, Section 7.2.3(b), or through an elastic buckling analysis, as applicable, ksi (MPa)

$$F_e = \frac{\pi^2 E}{\left(\frac{KL}{r} \right)^2} \quad (\text{E3-4})$$

User Note: The two inequalities for calculating the limits and applicability of Sections E3(a) and E3(b), one based on KL/r and one based on F_y/F_e , provide the same result.

E4. TORSIONAL AND FLEXURAL-TORSIONAL BUCKLING OF MEMBERS WITHOUT SLENDER ELEMENTS

This section applies to singly symmetric and unsymmetric members and certain doubly symmetric members, such as cruciform or built-up *columns* without slender elements, as defined in Section B4.1 for elements in uniform compression. In addition, this section applies to all doubly symmetric members without slender elements when the torsional *unbraced length* exceeds the lateral unbraced length. These provisions are required for single angles with $b/t > 20$.

The *nominal compressive strength*, P_n , shall be determined based on the *limit states* of *torsional* and *flexural-torsional buckling*, as follows:

$$P_n = F_{cr} A_g \quad (\text{E4-1})$$

The *critical stress*, F_{cr} , is determined as follows:

(a) For double angle and tee-shaped compression members:

$$F_{cr} = \left(\frac{F_{cry} + F_{crz}}{2H} \right) \left[1 - \sqrt{1 - \frac{4F_{cry}F_{crz}H}{(F_{cry} + F_{crz})^2}} \right] \quad (\text{E4-2})$$

where F_{cry} is taken as F_{cr} from Equation E3-2 or E3-3 for *flexural buckling* about the y -axis of symmetry, and $\frac{KL}{r} = \frac{K_y L}{r_y}$ for tee-shaped compression members, and $\frac{KL}{r} = \left(\frac{KL}{r} \right)_m$ from Section E6 for double angle compression members, and

$$F_{crz} = \frac{GJ}{A_g \bar{r}_o^2} \quad (\text{E4-3})$$

(b) For all other cases, F_{cr} shall be determined according to Equation E3-2 or E3-3, using the torsional or flexural-torsional elastic *buckling stress*, F_e , determined as follows:

(i) For doubly symmetric members:

$$F_e = \left[\frac{\pi^2 EC_w}{(K_z L)^2} + GJ \right] \frac{1}{I_x + I_y} \quad (\text{E4-4})$$

(ii) For singly symmetric members where y is the axis of symmetry:

$$F_e = \left(\frac{F_{ey} + F_{ez}}{2H} \right) \left[1 - \sqrt{1 - \frac{4F_{ey}F_{ez}H}{(F_{ey} + F_{ez})^2}} \right] \quad (\text{E4-5})$$

(iii) For unsymmetric members, F_e is the lowest root of the cubic equation:

$$(F_e - F_{ex})(F_e - F_{ey})(F_e - F_{ez}) - F_e^2(F_e - F_{ey})\left(\frac{x_o}{\bar{r}_o}\right)^2 - F_e^2(F_e - F_{ex})\left(\frac{y_o}{\bar{r}_o}\right)^2 = 0 \quad (\text{E4-6})$$

where

A_g = gross cross-sectional area of member, in.² (mm²)

C_w = warping constant, in.⁶ (mm⁶)

$$F_{ex} = \frac{\pi^2 E}{\left(\frac{K_x L}{r_x}\right)^2} \quad (\text{E4-7})$$

$$F_{ey} = \frac{\pi^2 E}{\left(\frac{K_y L}{r_y}\right)^2} \quad (\text{E4-8})$$

$$F_{ez} = \left(\frac{\pi^2 E C_w}{(K_z L)^2} + GJ \right) \frac{1}{A_g \bar{r}_o^2} \quad (\text{E4-9})$$

G = shear modulus of elasticity of steel = 11,200 ksi (77 200 MPa)

$$H = 1 - \frac{x_o^2 + y_o^2}{\bar{r}_o^2} \quad (\text{E4-10})$$

I_x, I_y = moment of inertia about the principal axes, in.⁴ (mm⁴)

J = torsional constant, in.⁴ (mm⁴)

K_x = effective length factor for flexural buckling about x -axis

K_y = effective length factor for flexural buckling about y -axis

K_z = effective length factor for torsional buckling

\bar{r}_o = polar radius of gyration about the shear center, in. (mm)

$$\bar{r}_o^2 = x_o^2 + y_o^2 + \frac{I_x + I_y}{A_g} \quad (\text{E4-11})$$

r_x = radius of gyration about x -axis, in. (mm)

r_y = radius of gyration about y -axis, in. (mm)

x_o, y_o = coordinates of the shear center with respect to the centroid, in. (mm)

User Note: For doubly symmetric I-shaped sections, C_w may be taken as $I_y h_o^2/4$, where h_o is the distance between flange centroids, in lieu of a more precise analysis. For tees and double angles, omit the term with C_w when computing F_{ez} and take x_o as 0.

E5. SINGLE ANGLE COMPRESSION MEMBERS

The *nominal compressive strength*, P_n , of single angle members shall be determined in accordance with Section E3 or Section E7, as appropriate, for axially loaded members. For single angles with $b/t > 20$, Section E4 shall be used. Members meeting the criteria imposed in Section E5(a) or E5(b) are permitted to be designed as axially loaded members using the specified effective slenderness ratio, KL/r .

The effects of eccentricity on single angle members are permitted to be neglected when evaluated as axially loaded compression members using one of the effective slenderness ratios specified in Section E5(a) or E5(b), provided that:

- (1) members are loaded at the ends in compression through the same one leg;
- (2) members are attached by welding or by *connections* with a minimum of two bolts; and
- (3) there are no intermediate transverse loads.

Single angle members with different end conditions from those described in Section E5(a) or (b), with the ratio of long leg width to short leg width greater than 1.7 or with transverse loading, shall be evaluated for combined axial load and flexure using the provisions of Chapter H.

- (a) For equal-leg angles or unequal-leg angles connected through the longer leg that are individual members or are web members of planar trusses with adjacent web members attached to the same side of the *gusset plate* or chord:

- (i) When $\frac{L}{r_x} \leq 80$:

$$\frac{KL}{r} = 72 + 0.75 \frac{L}{r_x} \quad (\text{E5-1})$$

- (ii) When $\frac{L}{r_x} > 80$:

$$\frac{KL}{r} = 32 + 1.25 \frac{L}{r_x} \leq 200 \quad (\text{E5-2})$$

For unequal-leg angles with leg length ratios less than 1.7 and connected through the shorter leg, KL/r from Equations E5-1 and E5-2 shall be increased by adding $4[(b_l/b_s)^2 - 1]$, but KL/r of the members shall not be taken as less than $0.95L/r_z$.

- (b) For equal-leg angles or unequal-leg angles connected through the longer leg that are web members of box or space trusses with adjacent web members attached to the same side of the *gusset plate* or chord:

- (i) When $\frac{L}{r_x} \leq 75$:

$$\frac{KL}{r} = 60 + 0.8 \frac{L}{r_x} \quad (\text{E5-3})$$

- (ii) When $\frac{L}{r_x} > 75$:

$$\frac{KL}{r} = 45 + \frac{L}{r_x} \leq 200 \quad (\text{E5-4})$$

For unequal-leg angles with leg length ratios less than 1.7 and connected through the shorter leg, KL/r from Equations E5-3 and E5-4 shall be increased by adding $6[(b_l/b_s)^2 - 1]$, but KL/r of the member shall not be taken as less than $0.82L/r_z$

where

L = length of member between work points at truss chord centerlines, in. (mm)

b_l = length of longer leg of angle, in. (mm)

b_s = length of shorter leg of angle, in. (mm)

r_x = radius of gyration about the *geometric axis* parallel to the connected leg, in. (mm)

r_z = radius of gyration about the minor principal axis, in. (mm)

E6. BUILT-UP MEMBERS

1. Compressive Strength

This section applies to *built-up members* composed of two shapes either (a) interconnected by bolts or welds, or (b) with at least one open side interconnected by perforated *cover plates* or *lacing* with *tie plates*. The end *connection* shall be welded or connected by means of *pretensioned bolts* with Class A or B *faying surfaces*.

User Note: It is acceptable to design a bolted end connection of a built-up compression member for the full compressive *load* with bolts in *bearing* and bolt design based on the shear strength; however, the bolts must be pretensioned. In built-up compression members, such as double-angle struts in trusses, a small relative *slip* between the elements especially at the end connections can increase the *effective length* of the combined cross section to that of the individual components and significantly reduce the compressive strength of the strut. Therefore, the connection between the elements at the ends of built-up members should be designed to resist slip.

The *nominal compressive strength* of built-up members composed of two shapes that are interconnected by bolts or welds shall be determined in accordance with Sections E3, E4 or E7 subject to the following modification. In lieu of more accurate analysis, if the *buckling* mode involves relative deformations that produce shear *forces* in the connectors between individual shapes, KL/r is replaced by $(KL/r)_m$ determined as follows:

(a) For intermediate connectors that are bolted snug-tight:

$$\left(\frac{KL}{r}\right)_m = \sqrt{\left(\frac{KL}{r}\right)_o^2 + \left(\frac{a}{l_i}\right)^2} \quad (\text{E6-1})$$

(b) For intermediate connectors that are welded or are connected by means of pretensioned bolts:

(i) When $\frac{a}{r_i} \leq 40$

$$\left(\frac{KL}{r}\right)_m = \left(\frac{KL}{r}\right)_o \quad (\text{E6-2a})$$

(ii) When $\frac{a}{r_i} > 40$

$$\left(\frac{KL}{r}\right)_m = \sqrt{\left(\frac{KL}{r}\right)_o^2 + \left(\frac{K_i a}{r_i}\right)^2} \quad (\text{E6-2b})$$

where

$\left(\frac{KL}{r}\right)_m$ = modified slenderness ratio of built-up member

$\left(\frac{KL}{r}\right)_o$ = slenderness ratio of built-up member acting as a unit in the buckling direction being considered

K_i = 0.50 for angles back-to-back
 = 0.75 for channels back-to-back
 = 0.86 for all other cases

a = distance between connectors, in. (mm)

r_i = minimum radius of gyration of individual component, in. (mm)

2. Dimensional Requirements

Individual components of compression members composed of two or more shapes shall be connected to one another at intervals, a , such that the effective slenderness ratio, Ka/r_i , of each of the component shapes between the *fasteners* does not exceed three-fourths times the governing slenderness ratio of the *built-up member*. The least radius of gyration, r_i , shall be used in computing the slenderness ratio of each component part.

At the ends of built-up compression members *bearing* on base plates or *finished surfaces*, all components in contact with one another shall be connected by a weld having a length not less than the maximum width of the member or by bolts spaced longitudinally not more than four diameters apart for a distance equal to 1½ times the maximum width of the member.

Along the length of built-up compression members between the end connections required above, longitudinal spacing for intermittent welds or bolts shall be adequate to provide for the transfer of the *required strength*. For limitations on the longitudinal spacing of fasteners between elements in continuous contact consisting of a plate and a shape or two plates, see Section J3.5. Where a component of a built-up compression member consists of an outside plate, the maximum spacing shall not exceed the thickness of the thinner outside plate times $0.75\sqrt{E/F_y}$ nor 12 in. (305 mm), when intermittent welds are provided along the edges of the components or when fasteners are provided on all *gage* lines at each section. When fasteners are staggered, the maximum spacing of fasteners on each gage line shall not exceed the thickness of the thinner outside plate times $1.12\sqrt{E/F_y}$ nor 18 in. (460 mm).

Open sides of compression members built up from plates or shapes shall be provided with continuous *cover plates* perforated with a succession of access holes. The unsupported width of such plates at access holes, as defined in Section B4.1, is assumed to contribute to the *available strength* provided the following requirements are met:

(1) The width-to-thickness ratio shall conform to the limitations of Section B4.1.

User Note: It is conservative to use the limiting width-to-thickness ratio for Case 7 in Table B4.1a with the width, b , taken as the transverse distance between the nearest lines of fasteners. The *net area* of the plate is taken at the widest hole. In lieu of this approach, the limiting width-to-thickness ratio may be determined through analysis.

- (2) The ratio of length (in direction of *stress*) to width of hole shall not exceed 2.
- (3) The clear distance between holes in the direction of stress shall be not less than the transverse distance between nearest lines of connecting fasteners or welds.
- (4) The periphery of the holes at all points shall have a minimum radius of $1\frac{1}{2}$ in. (38 mm).

As an alternative to perforated cover plates, *lacing with tie plates* is permitted at each end and at intermediate points if the lacing is interrupted. Tie plates shall be as near the ends as practicable. In members providing available strength, the end tie plates shall have a length of not less than the distance between the lines of fasteners or welds connecting them to the components of the member. Intermediate tie plates shall have a length not less than one-half of this distance. The thickness of tie plates shall be not less than one-fiftieth of the distance between lines of welds or fasteners connecting them to the segments of the members. In welded construction, the welding on each line connecting a tie plate shall total not less than one-third the length of the plate. In bolted construction, the spacing in the direction of stress in tie plates shall be not more than six diameters and the tie plates shall be connected to each segment by at least three fasteners.

Lacing, including flat bars, angles, channels or other shapes employed as lacing, shall be so spaced that the L/r ratio of the flange element included between their connections shall not exceed three-fourths times the governing slenderness ratio for the member as a whole. Lacing shall be proportioned to provide a shearing strength normal to the axis of the member equal to 2% of the *available compressive strength* of the member. The L/r ratio for lacing bars arranged in single systems shall not exceed 140. For double lacing this ratio shall not exceed 200. Double lacing bars shall be joined at the intersections. For lacing bars in compression, L is permitted to be taken as the unsupported length of the lacing bar between welds or fasteners connecting it to the components of the built-up member for single lacing, and 70% of that distance for double lacing.

User Note: The inclination of lacing bars to the axis of the member shall preferably be not less than 60° for single lacing and 45° for double lacing. When the distance between the lines of welds or fasteners in the flanges is more than 15 in. (380 mm), the lacing shall preferably be double or be made of angles.

For additional spacing requirements, see Section J3.5.

E7. MEMBERS WITH SLENDER ELEMENTS

This section applies to slender-element compression members, as defined in Section B4.1 for elements in uniform compression.

The *nominal compressive strength*, P_n , shall be the lowest value based on the applicable *limit states* of *flexural buckling*, *torsional buckling*, and *flexural-torsional buckling*.

$$P_n = F_{cr} A_g \quad (\text{E7-1})$$

The critical *stress*, F_{cr} , shall be determined as follows:

$$\begin{aligned} \text{(a) When } \frac{KL}{r} \leq 4.71 \sqrt{\frac{E}{QF_y}} \quad \left(\text{or } \frac{QF_y}{F_e} \leq 2.25 \right) \\ F_{cr} = Q \left[0.658 \frac{QF_y}{F_e} \right] F_y \end{aligned} \quad (\text{E7-2})$$

$$\begin{aligned} \text{(b) When } \frac{KL}{r} > 4.71 \sqrt{\frac{E}{QF_y}} \quad \left(\text{or } \frac{QF_y}{F_e} > 2.25 \right) \\ F_{cr} = 0.877 F_e \end{aligned} \quad (\text{E7-3})$$

where

F_e = elastic *buckling stress*, calculated using Equations E3-4 and E4-4 for doubly symmetric members, Equations E3-4 and E4-5 for singly symmetric members, and Equation E4-6 for unsymmetric members, except for single angles with $b/t \leq 20$, where F_e is calculated using Equation E3-4, ksi (MPa)

Q = net reduction factor accounting for all slender compression elements;
= 1.0 for members without slender elements, as defined in Section B4.1, for elements in uniform compression

= $Q_s Q_a$ for members with *slender-element sections*, as defined in Section B4.1, for elements in uniform compression.

User Note: For cross sections composed of only unstiffened slender elements, $Q = Q_s$ ($Q_a = 1.0$). For cross sections composed of only stiffened slender elements, $Q = Q_a$ ($Q_s = 1.0$). For cross sections composed of both stiffened and unstiffened slender elements, $Q = Q_s Q_a$. For cross sections composed of multiple unstiffened slender elements, it is conservative to use the smaller Q_s from the more slender element in determining the member strength for pure compression.

1. Slender Unstiffened Elements, Q_s

The reduction factor, Q_s , for slender *unstiffened elements* is defined as follows:

(a) For flanges, angles and plates projecting from rolled *columns* or other compression members:

$$(i) \text{ When } \frac{b}{t} \leq 0.56 \sqrt{\frac{E}{F_y}}$$

$$Q_s = 1.0 \quad (E7-4)$$

$$(ii) \text{ When } 0.56 \sqrt{\frac{E}{F_y}} < \frac{b}{t} < 1.03 \sqrt{\frac{E}{F_y}}$$

$$Q_s = 1.415 - 0.74 \left(\frac{b}{t} \right) \sqrt{\frac{F_y}{E}} \quad (E7-5)$$

$$(iii) \text{ When } \frac{b}{t} \geq 1.03 \sqrt{\frac{E}{F_y}}$$

$$Q_s = \frac{0.69E}{F_y \left(\frac{b}{t} \right)^2} \quad (E7-6)$$

(b) For flanges, angles and plates projecting from built-up I-shaped columns or other compression members:

$$(i) \text{ When } \frac{b}{t} \leq 0.64 \sqrt{\frac{Ek_c}{F_y}}$$

$$Q_s = 1.0 \quad (E7-7)$$

$$(ii) \text{ When } 0.64 \sqrt{\frac{Ek_c}{F_y}} < \frac{b}{t} \leq 1.17 \sqrt{\frac{Ek_c}{F_y}}$$

$$Q_s = 1.415 - 0.65 \left(\frac{b}{t} \right) \sqrt{\frac{F_y}{Ek_c}} \quad (E7-8)$$

$$(iii) \text{ When } \frac{b}{t} > 1.17 \sqrt{\frac{Ek_c}{F_y}}$$

$$Q_s = \frac{0.90Ek_c}{F_y \left(\frac{b}{t} \right)^2} \quad (E7-9)$$

where

b = width of unstiffened compression element, as defined in Section B4.1, in. (mm)

$k_c = \frac{4}{\sqrt{h/t_w}}$, and shall not be taken less than 0.35 nor greater than 0.76 for calculation purposes

t = thickness of element, in. (mm)

(c) For single angles

$$(i) \text{ When } \frac{b}{t} \leq 0.45 \sqrt{\frac{E}{F_y}}$$

$$Q_s = 1.0 \quad (\text{E7-10})$$

$$(ii) \text{ When } 0.45 \sqrt{\frac{E}{F_y}} < \frac{b}{t} \leq 0.91 \sqrt{\frac{E}{F_y}}$$

$$Q_s = 1.34 - 0.76 \left(\frac{b}{t} \right) \sqrt{\frac{F_y}{E}} \quad (\text{E7-11})$$

$$(iii) \text{ When } \frac{b}{t} > 0.91 \sqrt{\frac{E}{F_y}}$$

$$Q_s = \frac{0.53E}{F_y \left(\frac{b}{t} \right)^2} \quad (\text{E7-12})$$

where

b = full width of longest leg, in. (mm)

(d) For stems of tees

$$(i) \text{ When } \frac{d}{t} \leq 0.75 \sqrt{\frac{E}{F_y}}$$

$$Q_s = 1.0 \quad (\text{E7-13})$$

$$(ii) \text{ When } 0.75 \sqrt{\frac{E}{F_y}} < \frac{d}{t} \leq 1.03 \sqrt{\frac{E}{F_y}}$$

$$Q_s = 1.908 - 1.22 \left(\frac{d}{t} \right) \sqrt{\frac{F_y}{E}} \quad (\text{E7-14})$$

$$(iii) \text{ When } \frac{d}{t} > 1.03 \sqrt{\frac{E}{F_y}}$$

$$Q_s = \frac{0.69E}{F_y \left(\frac{d}{t} \right)^2} \quad (\text{E7-15})$$

where

d = full nominal depth of tee, in. (mm)

2. Slender Stiffened Elements, Q_a

The reduction factor, Q_a , for slender *stiffened elements* is defined as follows:

$$Q_a = \frac{A_e}{A_g} \quad (\text{E7-16})$$

where

A_g = gross cross-sectional area of member, in.² (mm²)

A_e = summation of the effective areas of the cross section based on the reduced *effective width*, b_e , in.² (mm²)

The reduced effective width, b_e , is determined as follows:

- (a) For uniformly compressed slender elements, with $\frac{b}{t} \geq 1.49 \sqrt{\frac{E}{f}}$, except flanges of square and rectangular sections of uniform thickness:

$$b_e = 1.92t \sqrt{\frac{E}{f}} \left[1 - \frac{0.34}{(b/t)} \sqrt{\frac{E}{f}} \right] \leq b \quad (\text{E7-17})$$

where

f is taken as F_{cr} with F_{cr} calculated based on $Q = 1.0$

- (b) For flanges of square and rectangular *slender-element sections* of uniform thickness with $\frac{b}{t} \geq 1.40 \sqrt{\frac{E}{f}}$:

$$b_e = 1.92t \sqrt{\frac{E}{f}} \left[1 - \frac{0.38}{(b/t)} \sqrt{\frac{E}{f}} \right] \leq b \quad (\text{E7-18})$$

where

$f = P_n/A_e$

User Note: In lieu of calculating $f = P_n/A_e$, which requires iteration, f may be taken equal to F_y . This will result in a slightly conservative estimate of *column available strength*.

- (c) For axially loaded circular sections:

When $0.11 \frac{E}{F_y} < \frac{D}{t} < 0.45 \frac{E}{F_y}$

$$Q = Q_a = \frac{0.038E}{F_y(D/t)} + \frac{2}{3} \quad (\text{E7-19})$$

where

D = outside diameter of round *HSS*, in. (mm)

t = thickness of wall, in. (mm)

CHAPTER F

DESIGN OF MEMBERS FOR FLEXURE

This chapter applies to members subject to simple bending about one principal axis. For simple bending, the member is loaded in a plane parallel to a principal axis that passes through the shear center or is restrained against twisting at *load* points and supports.

The chapter is organized as follows:







- F1. General Provisions
- F2. Doubly Symmetric Compact I-Shaped Members and Channels Bent About Their Major Axis
- F3. Doubly Symmetric I-Shaped Members with Compact Webs and Noncompact or Slender Flanges Bent About Their Major Axis
- F4. Other I-Shaped Members With Compact or Noncompact Webs Bent About Their Major Axis
- F5. Doubly Symmetric and Singly Symmetric I-Shaped Members With Slender Webs Bent About Their Major Axis
- F6. I-Shaped Members and Channels Bent About Their Minor Axis
- F7. Square and Rectangular HSS and Box-Shaped Members
- F8. Round HSS
- F9. Tees and Double Angles Loaded in the Plane of Symmetry
- F10. Single Angles
- F11. Rectangular Bars and Rounds
- F12. Unsymmetrical Shapes
- F13. Proportions of Beams and Girders

User Note: For cases not included in this chapter the following sections apply:

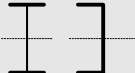
- Chapter G Design provisions for shear
- H1–H3 Members subject to biaxial flexure or to combined flexure and axial force
- H3 Members subject to flexure and torsion
- Appendix 3 Members subject to *fatigue*

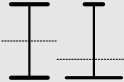
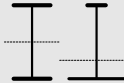
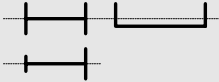
For guidance in determining the appropriate sections of this chapter to apply, Table User Note F1.1 may be used.

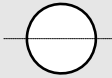
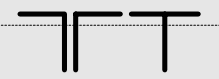
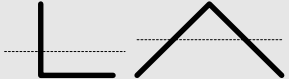
TABLE USER NOTE F1.1
Selection Table for the Application
of Chapter F Sections

Section in Chapter F	Cross Section	Flange Slenderness	Web Slenderness	Limit States
F2		C	C	Y, LTB
F3		NC, S	C	LTB, FLB
F4		C, NC, S	C, NC	Y, LTB, FLB, TFY
F5		C, NC, S	S	Y, LTB, FLB, TFY
F6		C, NC, S	N/A	Y, FLB
F7		C, NC, S	C, NC	Y, FLB, WLB
F8		N/A	N/A	Y, LB
F9		C, NC, S	N/A	Y, LTB, FLB
F10		N/A	N/A	Y, LTB, LLB
F11		N/A	N/A	Y, LTB
F12	Unsymmetrical shapes, other than single angles	N/A	N/A	All limit states

Y = yielding, LTB = lateral-torsional buckling, FLB = flange local buckling, WLB = web local buckling, TFY = tension flange yielding, LLB = leg local buckling, LB = local buckling, C = compact, NC = noncompact, S = slender

F1. GENERAL PROVISIONS

The *design flexural strength*, $\phi_b M_n$, and the *allowable flexural strength*, M_n/Ω_b , shall be determined as follows:

- (1) For all provisions in this chapter

$$\phi_b = 0.90 \text{ (LRFD)} \quad \Omega_b = 1.67 \text{ (ASD)}$$

and the *nominal flexural strength*, M_n , shall be determined according to Sections F2 through F13.

- (2) The provisions in this chapter are based on the assumption that points of support for *beams* and *girders* are restrained against rotation about their longitudinal axis.
- (3) For singly symmetric members in *single curvature* and all doubly symmetric members:

C_b , the *lateral-torsional buckling* modification factor for nonuniform moment diagrams when both ends of the segment are braced is determined as follows:

$$C_b = \frac{12.5M_{max}}{2.5M_{max} + 3M_A + 4M_B + 3M_C} \quad (\text{F1-1})$$

where

M_{max} = absolute value of maximum moment in the unbraced segment, kip-in. (N-mm)

M_A = absolute value of moment at quarter point of the unbraced segment, kip-in. (N-mm)

M_B = absolute value of moment at centerline of the unbraced segment, kip-in. (N-mm)

M_C = absolute value of moment at three-quarter point of the unbraced segment, kip-in. (N-mm)

For cantilevers or overhangs where the free end is unbraced, $C_b = 1.0$.

User Note: For doubly symmetric members with no transverse loading between brace points, Equation F1-1 reduces to 1.0 for the case of equal end moments of opposite sign (uniform moment), 2.27 for the case of equal end moments of the same sign (*reverse curvature* bending), and to 1.67 when one end moment equals zero. For singly symmetric members, a more detailed analysis for C_b is presented in the Commentary.

- (4) In singly symmetric members subject to reverse curvature bending, the *lateral-torsional buckling strength* shall be checked for both flanges. The available flexural strength shall be greater than or equal to the maximum required moment causing compression within the flange under consideration.

F2. DOUBLY SYMMETRIC COMPACT I-SHAPED MEMBERS AND CHANNELS BENT ABOUT THEIR MAJOR AXIS

This section applies to doubly symmetric I-shaped members and channels bent about their major axis, having compact webs and compact flanges as defined in Section B4.1 for flexure.

User Note: All current ASTM A6 W, S, M, C and MC shapes except W21×48, W14×99, W14×90, W12×65, W10×12, W8×31, W8×10, W6×15, W6×9, W6×8.5 and M4×6 have compact flanges for $F_y = 50$ ksi (345 MPa); all current ASTM A6 W, S, M, HP, C and MC shapes have compact webs at $F_y \leq 65$ ksi (450 MPa).

The *nominal flexural strength*, M_n , shall be the lower value obtained according to the *limit states of yielding (plastic moment)* and *lateral-torsional buckling*.

1. Yielding

$$M_n = M_p = F_y Z_x \quad (\text{F2-1})$$

where

$F_y =$ specified minimum yield stress of the type of steel being used, ksi (MPa)
 $Z_x =$ plastic section modulus about the x -axis, in.³ (mm³)

2. Lateral-Torsional Buckling

(a) When $L_b \leq L_p$, the *limit state of lateral-torsional buckling* does not apply.

(b) When $L_p < L_b \leq L_r$

$$M_n = C_b \left[M_p - (M_p - 0.7F_y S_x) \left(\frac{L_b - L_p}{L_r - L_p} \right) \right] \leq M_p \quad (\text{F2-2})$$

(c) When $L_b > L_r$

$$M_n = F_{cr} S_x \leq M_p \quad (\text{F2-3})$$

where

$L_b =$ length between points that are either braced against lateral displacement of the compression flange or braced against twist of the cross section, in. (mm)

$$F_{cr} = \frac{C_b \pi^2 E}{\left(\frac{L_b}{r_{ts}} \right)^2} \sqrt{1 + 0.078 \frac{Jc}{S_x h_o} \left(\frac{L_b}{r_{ts}} \right)^2} \quad (\text{F2-4})$$

and where

$E =$ modulus of elasticity of steel = 29,000 ksi (200 000 MPa)

$J =$ torsional constant, in.⁴ (mm⁴)

$S_x =$ elastic section modulus taken about the x -axis, in.³ (mm³)

$h_o =$ distance between the flange centroids, in. (mm)

User Note: The square root term in Equation F2-4 may be conservatively taken equal to 1.0.

User Note: Equations F2-3 and F2-4 provide identical solutions to the following expression for lateral-torsional buckling of doubly symmetric sections that has been presented in past editions of the AISC LRFD Specification:

$$M_{cr} = C_b \frac{\pi}{L_b} \sqrt{EI_y GJ + \left(\frac{\pi E}{L_b}\right)^2 I_y C_w}$$

The advantage of Equations F2-3 and F2-4 is that the form is very similar to the expression for lateral-torsional buckling of singly symmetric sections given in Equations F4-4 and F4-5.

The limiting lengths L_p and L_r are determined as follows:

$$L_p = 1.76 r_y \sqrt{\frac{E}{F_y}} \quad (\text{F2-5})$$

$$L_r = 1.95 r_{ts} \frac{E}{0.7 F_y} \sqrt{\frac{Jc}{S_x h_o} + \sqrt{\left(\frac{Jc}{S_x h_o}\right)^2 + 6.76 \left(\frac{0.7 F_y}{E}\right)^2}} \quad (\text{F2-6})$$

where

$$r_{ts}^2 = \frac{\sqrt{I_y C_w}}{S_x} \quad (\text{F2-7})$$

and the coefficient c is determined as follows:

(a) For doubly symmetric I-shapes: $c = 1$ (F2-8a)

(b) For channels: $c = \frac{h_o}{2} \sqrt{\frac{I_y}{C_w}}$ (F2-8b)

User Note: For doubly symmetric I-shapes with rectangular flanges, $C_w = \frac{I_y h_o^2}{4}$ and thus Equation F2-7 becomes

$$r_{ts}^2 = \frac{I_y h_o}{2 S_x}$$

r_{ts} may be approximated accurately and conservatively as the radius of gyration of the compression flange plus one-sixth of the web:

$$r_{ts} = \frac{b_f}{\sqrt{12 \left(1 + \frac{1}{6} \frac{h t_w}{b_f t_f}\right)}}$$

F3. DOUBLY SYMMETRIC I-SHAPED MEMBERS WITH COMPACT WEBS AND NONCOMPACT OR SLENDER FLANGES BENT ABOUT THEIR MAJOR AXIS

This section applies to doubly symmetric I-shaped members bent about their major axis having compact webs and noncompact or slender flanges as defined in Section B4.1 for flexure.

User Note: The following shapes have noncompact flanges for $F_y = 50$ ksi (345 MPa): W21×48, W14×99, W14×90, W12×65, W10×12, W8×31, W8×10, W6×15, W6×9, W6×8.5 and M4×6. All other ASTM A6 W, S and M shapes have compact flanges for $F_y \leq 50$ ksi (345 MPa).

The nominal flexural strength, M_n , shall be the lower value obtained according to the *limit states of lateral-torsional buckling* and *compression flange local buckling*.

1. Lateral-Torsional Buckling

For *lateral-torsional buckling*, the provisions of Section F2.2 shall apply.

2. Compression Flange Local Buckling

(a) For sections with noncompact flanges

$$M_n = M_p - (M_p - 0.7F_y S_x) \left(\frac{\lambda - \lambda_{pf}}{\lambda_{rf} - \lambda_{pf}} \right) \quad (\text{F3-1})$$

(b) For sections with slender flanges

$$M_n = \frac{0.9E k_c S_x}{\lambda^2} \quad (\text{F3-2})$$

where

$$\lambda = \frac{b_f}{2t_f}$$

$\lambda_{pf} = \lambda_p$ is the limiting slenderness for a compact flange, Table B4.1b

$\lambda_{rf} = \lambda_r$ is the limiting slenderness for a noncompact flange, Table B4.1b

$k_c = \frac{4}{\sqrt{h/t_w}}$ and shall not be taken less than 0.35 nor greater than 0.76 for calculation purposes

h = distance as defined in Section B4.1b, in. (mm)

F4. OTHER I-SHAPED MEMBERS WITH COMPACT OR NONCOMPACT WEBS BENT ABOUT THEIR MAJOR AXIS

This section applies to doubly symmetric I-shaped members bent about their major axis with noncompact webs and singly symmetric I-shaped members with webs attached to the mid-width of the flanges, bent about their major axis, with compact or noncompact webs, as defined in Section B4.1 for flexure.

User Note: I-shaped members for which this section is applicable may be designed conservatively using Section F5.

The nominal flexural strength, M_n , shall be the lowest value obtained according to the *limit states* of compression flange yielding, lateral-torsional buckling, compression flange local buckling, and tension flange yielding.

1. Compression Flange Yielding

$$M_n = R_{pc}M_{yc} = R_{pc}F_yS_{xc} \quad (\text{F4-1})$$

where

M_{yc} = yield moment in the compression flange, kip-in. (N-mm)

2. Lateral-Torsional Buckling

(a) When $L_b \leq L_p$, the *limit state* of lateral-torsional buckling does not apply.

(b) When $L_p < L_b \leq L_r$

$$M_n = C_b \left[R_{pc}M_{yc} - (R_{pc}M_{yc} - F_L S_{xc}) \left(\frac{L_b - L_p}{L_r - L_p} \right) \right] \leq R_{pc}M_{yc} \quad (\text{F4-2})$$

(c) When $L_b > L_r$

$$M_n = F_{cr}S_{xc} \leq R_{pc}M_{yc} \quad (\text{F4-3})$$

where

$$M_{yc} = F_y S_{xc} \quad (\text{F4-4})$$

$$F_{cr} = \frac{C_b \pi^2 E}{\left(\frac{L_b}{r_t} \right)^2} \sqrt{1 + 0.078 \frac{J}{S_{xc} h_o} \left(\frac{L_b}{r_t} \right)^2} \quad (\text{F4-5})$$

For $\frac{I_{yc}}{I_y} \leq 0.23$, J shall be taken as zero

where

I_{yc} = moment of inertia of the compression flange about the y-axis, in.⁴ (mm⁴)

The *stress*, F_L , is determined as follows:

(i) When $\frac{S_{xt}}{S_{xc}} \geq 0.7$

$$F_L = 0.7F_y \quad (\text{F4-6a})$$

(ii) When $\frac{S_{xt}}{S_{xc}} < 0.7$

$$F_L = F_y \frac{S_{xt}}{S_{xc}} \geq 0.5F_y \quad (\text{F4-6b})$$

The limiting laterally *unbraced length* for the limit state of *yielding*, L_p , is determined as:

$$L_p = 1.1r_t \sqrt{\frac{E}{F_y}} \quad (\text{F4-7})$$

The limiting unbraced length for the limit state of inelastic lateral-torsional buckling, L_r , is determined as:

$$L_r = 1.95r_t \frac{E}{F_L} \sqrt{\frac{J}{S_{xc}h_o} + \sqrt{\left(\frac{J}{S_{xc}h_o}\right)^2 + 6.76\left(\frac{F_L}{E}\right)^2}} \quad (\text{F4-8})$$

The web *plastification* factor, R_{pc} , shall be determined as follows:

(i) When $I_{yc}/I_y > 0.23$

(a) When $\frac{h_c}{t_w} \leq \lambda_{pw}$

$$R_{pc} = \frac{M_p}{M_{yc}} \quad (\text{F4-9a})$$

(b) When $\frac{h_c}{t_w} > \lambda_{pw}$

$$R_{pc} = \left[\frac{M_p}{M_{yc}} - \left(\frac{M_p}{M_{yc}} - 1 \right) \left(\frac{\lambda - \lambda_{pw}}{\lambda_{rw} - \lambda_{pw}} \right) \right] \leq \frac{M_p}{M_{yc}} \quad (\text{F4-9b})$$

(ii) When $I_{yc}/I_y \leq 0.23$

$$R_{pc} = 1.0 \quad (\text{F4-10})$$

where

$$M_p = F_y Z_x \leq 1.6F_y S_{xc}$$

S_{xc}, S_{xt} = elastic section modulus referred to compression and tension flanges, respectively, in.³ (mm³)

$$\lambda = \frac{h_c}{t_w}$$

λ_{pw} = λ_p , the limiting slenderness for a compact web, Table B4.1b

λ_{rw} = λ_r , the limiting slenderness for a noncompact web, Table B4.1b

h_c = twice the distance from the centroid to the following: the inside face of the compression flange less the fillet or corner radius, for rolled shapes; the nearest line of *fasteners* at the compression flange or the inside faces of the compression flange when welds are used, for *built-up sections*, in. (mm)

The effective radius of gyration for lateral-torsional buckling, r_t , is determined as follows:

- (i) For I-shapes with a rectangular compression flange

$$r_t = \frac{b_{fc}}{\sqrt{12 \left(\frac{h_o}{d} + \frac{1}{6} a_w \frac{h^2}{h_o d} \right)}} \quad (\text{F4-11})$$

where

$$a_w = \frac{h_c t_w}{b_{fc} t_{fc}} \quad (\text{F4-12})$$

b_{fc} = width of compression flange, in. (mm)

t_{fc} = compression flange thickness, in. (mm)

- (ii) For I-shapes with a channel cap or a *cover plate* attached to the compression flange

r_t = radius of gyration of the flange components in flexural compression plus one-third of the web area in compression due to application of major axis bending moment alone, in. (mm)

a_w = the ratio of two times the web area in compression due to application of major axis bending moment alone to the area of the compression flange components

User Note: For I-shapes with a rectangular compression flange, r_t may be approximated accurately and conservatively as the radius of gyration of the compression flange plus one-third of the compression portion of the web; in other words

$$r_t = \frac{b_{fc}}{\sqrt{12 \left(1 + \frac{1}{6} a_w \right)}}$$

3. Compression Flange Local Buckling

- (a) For sections with compact flanges, the *limit state* of *local buckling* does not apply.
 (b) For sections with noncompact flanges

$$M_n = R_{pc} M_{yc} - (R_{pc} M_{yc} - F_L S_{xc}) \left(\frac{\lambda - \lambda_{pf}}{\lambda_{rf} - \lambda_{pf}} \right) \quad (\text{F4-13})$$

- (c) For sections with slender flanges

$$M_n = \frac{0.9 E k_c S_{xc}}{\lambda^2} \quad (\text{F4-14})$$

where

F_L is defined in Equations F4-6a and F4-6b

R_{pc} is the web *plastification* factor, determined by Equations F4-9

$k_c = \frac{4}{\sqrt{h/t_w}}$ and shall not be taken less than 0.35 nor greater than 0.76 for calculation purposes

$$\lambda = \frac{b_{fc}}{2t_{fc}}$$

$\lambda_{pf} = \lambda_p$, the limiting slenderness for a compact flange, Table B4.1b

$\lambda_{rf} = \lambda_r$, the limiting slenderness for a noncompact flange, Table B4.1b

4. Tension Flange Yielding

(a) When $S_{xt} \geq S_{xc}$, the *limit state* of tension flange yielding does not apply.

(b) When $S_{xt} < S_{xc}$

$$M_n = R_{pt} M_{yt} \tag{F4-15}$$

where

$$M_{yt} = F_y S_{xt}$$

The web *plastification* factor corresponding to the tension flange yielding limit state, R_{pt} , is determined as follows:

(i) When $\frac{h_c}{t_w} \leq \lambda_{pw}$

$$R_{pt} = \frac{M_p}{M_{yt}} \tag{F4-16a}$$

(ii) When $\frac{h_c}{t_w} > \lambda_{pw}$

$$R_{pt} = \left[\frac{M_p}{M_{yt}} - \left(\frac{M_p}{M_{yt}} - 1 \right) \left(\frac{\lambda - \lambda_{pw}}{\lambda_{rw} - \lambda_{pw}} \right) \right] \leq \frac{M_p}{M_{yt}} \tag{F4-16b}$$

where

$$\lambda = \frac{h_c}{t_w}$$

$\lambda_{pw} = \lambda_p$, the limiting slenderness for a compact web, defined in Table B4.1b

$\lambda_{rw} = \lambda_r$, the limiting slenderness for a noncompact web, defined in Table B4.1b

F5. DOUBLY SYMMETRIC AND SINGLY SYMMETRIC I-SHAPED MEMBERS WITH SLENDER WEBS BENT ABOUT THEIR MAJOR AXIS

This section applies to doubly symmetric and singly symmetric I-shaped members with slender webs attached to the mid-width of the flanges and bent about their major axis as defined in Section B4.1 for flexure.

The nominal flexural strength, M_n , shall be the lowest value obtained according to the *limit states* of compression flange yielding, lateral-torsional buckling, compression flange local buckling, and tension flange yielding.

1. Compression Flange Yielding

$$M_n = R_{pg} F_y S_{xc} \quad (\text{F5-1})$$

2. Lateral-Torsional Buckling

$$M_n = R_{pg} F_{cr} S_{xc} \quad (\text{F5-2})$$

(a) When $L_b \leq L_p$, the *limit state* of lateral-torsional buckling does not apply.

(b) When $L_p < L_b \leq L_r$

$$F_{cr} = C_b \left[F_y - (0.3F_y) \left(\frac{L_b - L_p}{L_r - L_p} \right) \right] \leq F_y \quad (\text{F5-3})$$

(c) When $L_b > L_r$

$$F_{cr} = \frac{C_b \pi^2 E}{\left(\frac{L_b}{r_t} \right)^2} \leq F_y \quad (\text{F5-4})$$

where

L_p is defined by Equation F4-7

$$L_r = \pi r_t \sqrt{\frac{E}{0.7F_y}} \quad (\text{F5-5})$$

R_{pg} , the bending strength reduction factor is determined as follows:

$$R_{pg} = 1 - \frac{a_w}{1,200 + 300a_w} \left(\frac{h_c}{t_w} - 5.7 \sqrt{\frac{E}{F_y}} \right) \leq 1.0 \quad (\text{F5-6})$$

where

a_w is defined by Equation F4-12 but shall not exceed 10

r_t is the effective radius of gyration for lateral buckling as defined in Section F4

3. Compression Flange Local Buckling

$$M_n = R_{pg} F_{cr} S_{xc} \quad (\text{F5-7})$$

- (a) For sections with compact flanges, the *limit state* of compression flange *local buckling* does not apply.
 (b) For sections with noncompact flanges

$$F_{cr} = \left[F_y - (0.3F_y) \left(\frac{\lambda - \lambda_{pf}}{\lambda_{rf} - \lambda_{pf}} \right) \right] \quad (\text{F5-8})$$

- (c) For sections with slender flanges

$$F_{cr} = \frac{0.9Ek_c}{\left(\frac{b_f}{2t_f} \right)^2} \quad (\text{F5-9})$$

where

$$k_c = \frac{4}{\sqrt{h/t_w}} \text{ and shall not be taken less than } 0.35 \text{ nor greater than } 0.76 \text{ for calculation purposes}$$

$$\lambda = \frac{b_{fc}}{2t_{fc}}$$

$\lambda_{pf} = \lambda_p$, the limiting slenderness for a compact flange, Table B4.1b

$\lambda_{rf} = \lambda_r$, the limiting slenderness for a noncompact flange, Table B4.1b

4. Tension Flange Yielding

- (a) When $S_{xt} \geq S_{xc}$, the *limit state* of tension flange *yielding* does not apply.
 (b) When $S_{xt} < S_{xc}$

$$M_n = F_y S_{xt} \quad (\text{F5-10})$$

F6. I-SHAPED MEMBERS AND CHANNELS BENT ABOUT THEIR MINOR AXIS

This section applies to I-shaped members and channels bent about their minor axis.

The nominal flexural strength, M_n , shall be the lower value obtained according to the *limit states* of *yielding (plastic moment)* and *flange local buckling*.

1. Yielding

$$M_n = M_p = F_y Z_y \leq 1.6F_y S_y \quad (\text{F6-1})$$

2. Flange Local Buckling

- (a) For sections with compact flanges the *limit state* of flange *local buckling* does not apply.

User Note: All current ASTM A6 W, S, M, C and MC shapes except W21×48, W14×99, W14×90, W12×65, W10×12, W8×31, W8×10, W6×15, W6×9, W6×8.5 and M4×6 have compact flanges at $F_y = 50$ ksi (345 MPa).

(b) For sections with noncompact flanges

$$M_n = \left[M_p - (M_p - 0.7F_y S_y) \left(\frac{\lambda - \lambda_{pf}}{\lambda_{rf} - \lambda_{pf}} \right) \right] \quad (F6-2)$$

(c) For sections with slender flanges

$$M_n = F_{cr} S_y \quad (F6-3)$$

where

$$F_{cr} = \frac{0.69E}{\left(\frac{b}{t_f} \right)^2} \quad (F6-4)$$

$$\lambda = \frac{b}{t_f}$$

$\lambda_{pf} = \lambda_p$, the limiting slenderness for a compact flange, Table B4.1b

$\lambda_{rf} = \lambda_r$, the limiting slenderness for a noncompact flange, Table B4.1b

b = for flanges of I-shaped members, half the full-flange width, b_f ; for flanges of channels, the full *nominal dimension* of the flange, in. (mm)

t_f = thickness of the flange, in. (mm)

S_y = elastic section modulus taken about the y-axis, in.³ (mm³); for a channel, the minimum section modulus

F7. SQUARE AND RECTANGULAR HSS AND BOX-SHAPED MEMBERS

This section applies to square and rectangular *HSS*, and doubly symmetric box-shaped members bent about either axis, having compact or noncompact webs and compact, noncompact or slender flanges as defined in Section B4.1 for flexure.

The nominal flexural strength, M_n , shall be the lowest value obtained according to the *limit states* of *yielding (plastic moment)*, *flange local buckling* and *web local buckling* under pure flexure.

User Note: Very long rectangular *HSS* bent about the major axis are subject to *lateral-torsional buckling*; however, the Specification provides no strength equation for this limit state since *beam* deflection will control for all reasonable cases.

1. Yielding

$$M_n = M_p = F_y Z \quad (F7-1)$$

where

Z = plastic section modulus about the axis of bending, in.³ (mm³)

2. Flange Local Buckling

- (a) For *compact sections*, the *limit state* of flange *local buckling* does not apply.
 (b) For sections with noncompact flanges

$$M_n = M_p - (M_p - F_y S) \left(3.57 \frac{b}{t_f} \sqrt{\frac{F_y}{E}} - 4.0 \right) \leq M_p \quad (\text{F7-2})$$

- (c) For sections with slender flanges

$$M_n = F_y S_e \quad (\text{F7-3})$$

where

S_e = effective section modulus determined with the effective width, b_e , of the compression flange taken as:

$$b_e = 1.92 t_f \sqrt{\frac{E}{F_y}} \left[1 - \frac{0.38}{b/t_f} \sqrt{\frac{E}{F_y}} \right] \leq b \quad (\text{F7-4})$$

3. Web Local Buckling

- (a) For *compact sections*, the *limit state* of web *local buckling* does not apply.
 (b) For sections with noncompact webs

$$M_n = M_p - (M_p - F_y S) \left(0.305 \frac{h}{t_w} \sqrt{\frac{F_y}{E}} - 0.738 \right) \leq M_p \quad (\text{F7-5})$$

F8. ROUND HSS

This section applies to round *HSS* having D/t ratios of less than $\frac{0.45E}{F_y}$.

The nominal flexural strength, M_n , shall be the lower value obtained according to the *limit states* of *yielding (plastic moment)* and *local buckling*.

1. Yielding

$$M_n = M_p = F_y Z \quad (\text{F8-1})$$

2. Local Buckling

- (a) For *compact sections*, the *limit state* of flange *local buckling* does not apply.
 (b) For *noncompact sections*

$$M_n = \left(\frac{0.021E}{\left(\frac{D}{t}\right)} + F_y \right) S \quad (\text{F8-2})$$

- (c) For sections with slender walls

$$M_n = F_{cr} S \quad (\text{F8-3})$$

where

$$F_{cr} = \frac{0.33E}{\left(\frac{D}{t}\right)} \quad (\text{F8-4})$$

S = elastic section modulus, in.³ (mm³)

t = thickness of wall, in. (mm)

F9. TEES AND DOUBLE ANGLES LOADED IN THE PLANE OF SYMMETRY

This section applies to tees and double angles loaded in the plane of symmetry.

The nominal flexural strength, M_n , shall be the lowest value obtained according to the *limit states* of *yielding (plastic moment)*, *lateral-torsional buckling*, *flange local buckling*, and local buckling of tee stems.

1. Yielding

$$M_n = M_p \quad (\text{F9-1})$$

where

(a) For stems in tension

$$M_p = F_y Z_x \leq 1.6M_y \quad (\text{F9-2})$$

(b) For stems in compression

$$M_p = F_y Z_x \leq M_y \quad (\text{F9-3})$$

2. Lateral-Torsional Buckling

$$M_n = M_{cr} = \frac{\pi\sqrt{EI_y GJ}}{L_b} \left(B + \sqrt{1 + B^2} \right) \quad (\text{F9-4})$$

where

$$B = \pm 2.3 \left(\frac{d}{L_b} \right) \sqrt{\frac{I_y}{J}} \quad (\text{F9-5})$$

The plus sign for B applies when the stem is in tension and the minus sign applies when the stem is in compression. If the tip of the stem is in compression anywhere along the *unbraced length*, the negative value of B shall be used.

3. Flange Local Buckling of Tees

(a) For sections with a compact flange in flexural compression, the *limit state* of *flange local buckling* does not apply.

(b) For sections with a noncompact flange in flexural compression

$$M_n = M_p - (M_p - 0.7F_y S_{xc}) \left(\frac{\lambda - \lambda_{pf}}{\lambda_{rf} - \lambda_{pf}} \right) \leq 1.6M_y \quad (\text{F9-6})$$

(c) For sections with a slender flange in flexural compression

$$M_n = \frac{0.7ES_{xc}}{\left(\frac{b_f}{2t_f} \right)^2} \quad (\text{F9-7})$$

where

S_{xc} = elastic section modulus referred to the compression flange, in.³ (mm³)

$$\lambda = \frac{b_f}{2t_f}$$

$\lambda_{pf} = \lambda_p$, the limiting slenderness for a compact flange, Table B4.1b

$\lambda_{rf} = \lambda_r$, the limiting slenderness for a noncompact flange, Table B4.1b

User Note: For double angles with flange legs in compression, M_n based on local buckling is to be determined using the provisions of Section F10.3 with b/t of the flange legs and Equation F10-1 as an upper limit.

4. Local Buckling of Tee Stems in Flexural Compression

$$M_n = F_{cr} S_x \quad (\text{F9-8})$$

where

S_x = elastic section modulus, in.³ (mm³)

The critical *stress*, F_{cr} , is determined as follows:

(a) When $\frac{d}{t_w} \leq 0.84 \sqrt{\frac{E}{F_y}}$

$$F_{cr} = F_y \quad (\text{F9-9})$$

(b) When $0.84 \sqrt{\frac{E}{F_y}} < \frac{d}{t_w} \leq 1.03 \sqrt{\frac{E}{F_y}}$

$$F_{cr} = \left[2.55 - 1.84 \frac{d}{t_w} \sqrt{\frac{F_y}{E}} \right] F_y \quad (\text{F9-10})$$

(c) When $\frac{d}{t_w} > 1.03 \sqrt{\frac{E}{F_y}}$

$$F_{cr} = \frac{0.69E}{\left(\frac{d}{t_w} \right)^2} \quad (\text{F9-11})$$

User note: For double angles with web legs in compression, M_n based on *local buckling* is to be determined using the provisions of Section F10.3 with b/t of the web legs and Equation F10-1 as an upper limit.

F10. SINGLE ANGLES

This section applies to single angles with and without continuous lateral restraint along their length.

Single angles with continuous lateral-torsional restraint along the length are permitted to be designed on the basis of *geometric axis* (x, y) bending. Single angles without continuous lateral-torsional restraint along the length shall be designed using the provisions for *principal axis* bending except where the provision for bending about a geometric axis is permitted.

If the moment resultant has components about both principal axes, with or without axial load, or the moment is about one principal axis and there is axial load, the combined *stress* ratio shall be determined using the provisions of Section H2.

User Note: For geometric axis design, use section properties computed about the x - and y -axis of the angle, parallel and perpendicular to the legs. For principal axis design, use section properties computed about the major and minor principal axes of the angle.

The *nominal flexural strength*, M_n , shall be the lowest value obtained according to the *limit states of yielding (plastic moment), lateral-torsional buckling, and leg local buckling*.

User Note: For bending about the minor axis, only the limit states of yielding and leg local buckling apply.

1. Yielding

$$M_n = 1.5M_y \quad (\text{F10-1})$$

where

M_y = yield moment about the axis of bending, kip-in. (N-mm)

2. Lateral-Torsional Buckling

For single angles without continuous lateral-torsional restraint along the length

(a) When $M_e \leq M_y$

$$M_n = \left(0.92 - \frac{0.17M_e}{M_y} \right) M_e \quad (\text{F10-2})$$

(b) When $M_e > M_y$

$$M_n = \left(1.92 - 1.17 \sqrt{\frac{M_y}{M_e}} \right) M_y \leq 1.5 M_y \quad (\text{F10-3})$$

where

M_e , the elastic *lateral-torsional buckling* moment, is determined as follows:

(i) For bending about the major principal axis of equal-leg angles:

$$M_e = \frac{0.46 E b^2 t^2 C_b}{L_b} \quad (\text{F10-4})$$

(ii) For bending about the major principal axis of unequal-leg angles:

$$M_e = \frac{4.9 E I_z C_b}{L_b^2} \left(\sqrt{\beta_w^2 + 0.052 \left(\frac{L_b t}{r_z} \right)^2} + \beta_w \right) \quad (\text{F10-5})$$

where

C_b is computed using Equation F1-1 with a maximum value of 1.5

L_b = laterally *unbraced length* of member, in. (mm)

I_z = minor principal axis moment of inertia, in.⁴ (mm⁴)

r_z = radius of gyration about the minor principal axis, in. (mm)

t = thickness of angle leg, in. (mm)

β_w = section property for unequal leg angles, positive for short legs in compression and negative for long legs in compression. If the long leg is in compression anywhere along the unbraced length of the member, the negative value of β_w shall be used.

User Note: The equation for β_w and values for common angle sizes are listed in the Commentary.

(iii) For bending moment about one of the *geometric axes* of an equal-leg angle with no axial compression

(a) And with no lateral-torsional restraint:

(i) With maximum compression at the toe

$$M_e = \frac{0.66 E b^4 t C_b}{L_b^2} \left(\sqrt{1 + 0.78 \left(\frac{L_b t}{b^2} \right)^2} - 1 \right) \quad (\text{F10-6a})$$

(ii) With maximum tension at the toe

$$M_e = \frac{0.66 E b^4 t C_b}{L_b^2} \left(\sqrt{1 + 0.78 \left(\frac{L_b t}{b^2} \right)^2} + 1 \right) \quad (\text{F10-6b})$$

M_y shall be taken as 0.80 times the *yield moment* calculated using the geometric section modulus.

where

b = full width of leg in compression, in. (mm)

User Note: M_n may be taken as M_y for single angles with their vertical leg toe in compression, and having a span-to-depth ratio less than or equal to

$$\frac{1.64E}{F_y} \sqrt{\left(\frac{t}{b}\right)^2 - 1.4 \frac{F_y}{E}}$$

(b) And with lateral-torsional restraint at the point of maximum moment only:

M_e shall be taken as 1.25 times M_e computed using Equation F10-6a or F10-6b.

M_y shall be taken as the yield moment calculated using the geometric section modulus.

3. Leg Local Buckling

The *limit state* of leg *local buckling* applies when the toe of the leg is in compression.

- (a) For *compact sections*, the limit state of leg local buckling does not apply.
 (b) For sections with noncompact legs:

$$M_n = F_y S_c \left(2.43 - 1.72 \left(\frac{b}{t} \right) \sqrt{\frac{F_y}{E}} \right) \quad (\text{F10-7})$$

(c) For sections with slender legs:

$$M_n = F_{cr} S_c \quad (\text{F10-8})$$

where

$$F_{cr} = \frac{0.71E}{\left(\frac{b}{t}\right)^2} \quad (\text{F10-9})$$

S_c = elastic section modulus to the toe in compression relative to the axis of bending, in.³ (mm³). For bending about one of the *geometric axes* of an equal-leg angle with no lateral-torsional restraint, S_c shall be 0.80 of the geometric axis section modulus.

F11. RECTANGULAR BARS AND ROUNDS

This section applies to rectangular bars bent about either *geometric axis* and rounds.

The *nominal flexural strength*, M_n , shall be the lower value obtained according to the *limit states* of *yielding (plastic moment)* and *lateral-torsional buckling*.

1. Yielding

For rectangular bars with $\frac{L_b d}{t^2} \leq \frac{0.08E}{F_y}$ bent about their major axis, rectangular bars bent about their minor axis and rounds:

$$M_n = M_p = F_y Z \leq 1.6M_y \quad (\text{F11-1})$$

2. Lateral-Torsional Buckling

(a) For rectangular bars with $\frac{0.08E}{F_y} < \frac{L_b d}{t^2} \leq \frac{1.9E}{F_y}$ bent about their major axis:

$$M_n = C_b \left[1.52 - 0.274 \left(\frac{L_b d}{t^2} \right) \frac{F_y}{E} \right] M_y \leq M_p \quad (\text{F11-2})$$

(b) For rectangular bars with $\frac{L_b d}{t^2} > \frac{1.9E}{F_y}$ bent about their major axis:

$$M_n = F_{cr} S_x \leq M_p \quad (\text{F11-3})$$

where

$$F_{cr} = \frac{1.9EC_b}{\frac{L_b d}{t^2}} \quad (\text{F11-4})$$

L_b = length between points that are either braced against lateral displacement of the compression region, or between points braced to prevent twist of the cross section, in. (mm)

d = depth of rectangular bar, in. (mm)

t = width of rectangular bar parallel to axis of bending, in. (mm)

(c) For rounds and rectangular bars bent about their minor axis, the *limit state of lateral-torsional buckling* need not be considered.

F12. UNSYMMETRICAL SHAPES

This section applies to all unsymmetrical shapes, except single angles.

The *nominal flexural strength*, M_n , shall be the lowest value obtained according to the *limit states of yielding (yield moment), lateral-torsional buckling, and local buckling* where

$$M_n = F_n S_{min} \quad (\text{F12-1})$$

where

S_{min} = lowest elastic section modulus relative to the axis of bending, in.³ (mm³)

1. Yielding

$$F_n = F_y \quad (\text{F12-2})$$

2. Lateral-Torsional Buckling

$$F_n = F_{cr} \leq F_y \quad (\text{F12-3})$$

where

F_{cr} = lateral-torsional buckling stress for the section as determined by analysis, ksi (MPa)

User Note: In the case of Z-shaped members, it is recommended that F_{cr} be taken as $0.5F_{cr}$ of a channel with the same flange and web properties.

3. Local Buckling

$$F_n = F_{cr} \leq F_y \quad (\text{F12-4})$$

where

F_{cr} = local buckling stress for the section as determined by analysis, ksi (MPa)

F13. PROPORTIONS OF BEAMS AND GIRDERS

1. Strength Reductions for Members With Holes in the Tension Flange

This section applies to rolled or *built-up shapes* and cover-plated *beams* with holes, proportioned on the basis of flexural strength of the gross section.

In addition to the *limit states* specified in other sections of this Chapter, the *nominal flexural strength*, M_n , shall be limited according to the limit state of *tensile rupture* of the tension flange.

- (a) When $F_u A_{fn} \geq Y_t F_y A_{fg}$, the limit state of tensile rupture does not apply.
- (b) When $F_u A_{fn} < Y_t F_y A_{fg}$, the nominal flexural strength, M_n , at the location of the holes in the tension flange shall not be taken greater than

$$M_n = \frac{F_u A_{fn}}{A_{fg}} S_x \quad (\text{F13-1})$$

where

A_{fg} = gross area of tension flange, calculated in accordance with the provisions of Section B4.3a, in.² (mm²)

A_{fn} = net area of tension flange, calculated in accordance with the provisions of Section B4.3b, in.² (mm²)

Y_t = 1.0 for $F_y/F_u \leq 0.8$
= 1.1 otherwise

2. Proportioning Limits for I-Shaped Members

Singly symmetric I-shaped members shall satisfy the following limit:

$$0.1 \leq \frac{I_{yc}}{I_y} \leq 0.9 \quad (\text{F13-2})$$

I-shaped members with slender webs shall also satisfy the following limits:

(a) When $\frac{a}{h} \leq 1.5$

$$\left(\frac{h}{t_w}\right)_{max} = 12.0 \sqrt{\frac{E}{F_y}} \quad (\text{F13-3})$$

(b) When $\frac{a}{h} > 1.5$

$$\left(\frac{h}{t_w}\right)_{max} = \frac{0.40E}{F_y} \quad (\text{F13-4})$$

where

a = clear distance between *transverse stiffeners*, in. (mm)

In unstiffened girders h/t_w shall not exceed 260. The ratio of the web area to the compression flange area shall not exceed 10.

3. Cover Plates

Flanges of welded *beams* or girders may be varied in thickness or width by splicing a series of plates or by the use of *cover plates*.

The total cross-sectional area of cover plates of bolted girders shall not exceed 70% of the total flange area.

High-strength bolts or welds connecting flange to web, or cover plate to flange, shall be proportioned to resist the total *horizontal shear* resulting from the bending *forces* on the girder. The longitudinal distribution of these bolts or intermittent welds shall be in proportion to the intensity of the shear.

However, the longitudinal spacing shall not exceed the maximum specified for compression or tension members in Section E6 or D4, respectively. Bolts or welds connecting flange to web shall also be proportioned to transmit to the web any *loads* applied directly to the flange, unless provision is made to transmit such loads by direct *bearing*.

Partial-length cover plates shall be extended beyond the theoretical cutoff point and the extended portion shall be attached to the beam or girder by high-strength bolts in a slip-critical *connection* or *fillet welds*. The attachment shall be adequate, at the applicable strength given in Sections J2.2, J3.8 or B3.11 to develop the cover plate's portion of the flexural strength in the beam or girder at the theoretical cutoff point.

For welded cover plates, the welds connecting the cover plate termination to the beam or girder shall have continuous welds along both edges of the cover plate in the length a' , defined below, and shall be adequate to develop the cover plate's portion of the *available strength* of the beam or girder at the distance a' from the end of the cover plate.

- (a) When there is a continuous weld equal to or larger than three-fourths of the plate thickness across the end of the plate

$$a' = w \quad (\text{F13-5})$$

where

w = width of cover plate, in. (mm)

- (b) When there is a continuous weld smaller than three-fourths of the plate thickness across the end of the plate

$$a' = 1.5w \quad (\text{F13-6})$$

- (c) When there is no weld across the end of the plate

$$a' = 2w \quad (\text{F13-7})$$

4. Built-Up Beams

Where two or more *beams* or channels are used side-by-side to form a flexural member, they shall be connected together in compliance with Section E6.2. When concentrated *loads* are carried from one beam to another or distributed between the beams, *diaphragms* having sufficient *stiffness* to distribute the load shall be welded or bolted between the beams.

5. Unbraced Length for Moment Redistribution

For moment redistribution in *beams* according to Section B3.7, the laterally *unbraced length*, L_b , of the compression flange adjacent to the redistributed end moment locations shall not exceed L_m determined as follows.

- (a) For doubly symmetric and singly symmetric I-shaped beams with the compression flange equal to or larger than the tension flange loaded in the plane of the web:

$$L_m = \left[0.12 + 0.076 \left(\frac{M_1}{M_2} \right) \right] \left(\frac{E}{F_y} \right) r_y \quad (\text{F13-8})$$

- (b) For solid rectangular bars and symmetric box beams bent about their major axis:

$$L_m = \left[0.17 + 0.10 \left(\frac{M_1}{M_2} \right) \right] \left(\frac{E}{F_y} \right) r_y \geq 0.10 \left(\frac{E}{F_y} \right) r_y \quad (\text{F13-9})$$

where

F_y = specified minimum yield stress of the compression flange, ksi (MPa)

M_1 = smaller moment at end of unbraced length, kip-in. (N-mm)

M_2 = larger moment at end of unbraced length, kip-in. (N-mm)

r_y = radius of gyration about y-axis, in. (mm)

(M_1/M_2) is positive when moments cause *reverse curvature* and negative for *single curvature*

There is no limit on L_b for members with round or square cross sections or for any beam bent about its minor axis.

CHAPTER G

DESIGN OF MEMBERS FOR SHEAR

This chapter addresses webs of singly or doubly symmetric members subject to shear in the plane of the web, single angles and *HSS* sections, and shear in the weak direction of singly or doubly symmetric shapes.

The chapter is organized as follows:

- G1. General Provisions
- G2. Members with Unstiffened or Stiffened Webs
- G3. Tension Field Action
- G4. Single Angles
- G5. Rectangular HSS and Box-Shaped Members
- G6. Round HSS
- G7. Weak Axis Shear in Doubly Symmetric and Singly Symmetric Shapes
- G8. Beams and Girders with Web Openings

User Note: For cases not included in this chapter, the following sections apply:

- H3.3 Unsymmetric sections
- J4.2 Shear strength of connecting elements
- J10.6 Web *panel zone* shear

G1. GENERAL PROVISIONS

Two methods of calculating shear strength are presented below. The method presented in Section G2 does not utilize the post *buckling strength* of the member (*tension field action*). The method presented in Section G3 utilizes tension field action.

The *design shear strength*, $\phi_v V_n$, and the *allowable shear strength*, V_n/Ω_v , shall be determined as follows:

For all provisions in this chapter except Section G2.1(a):

$$\phi_v = 0.90 \text{ (LRFD)} \quad \Omega_v = 1.67 \text{ (ASD)}$$

G2. MEMBERS WITH UNSTIFFENED OR STIFFENED WEBS

1. Shear Strength

This section applies to webs of singly or doubly symmetric members and channels subject to shear in the plane of the web.

The *nominal shear strength*, V_n , of unstiffened or stiffened webs according to the *limit states of shear yielding and shear buckling*, is

$$V_n = 0.6F_y A_w C_v \tag{G2-1}$$

- (a) For webs of rolled I-shaped members with $h/t_w \leq 2.24\sqrt{E/F_y}$:

$$\phi_v = 1.00 \text{ (LRFD)} \quad \Omega_v = 1.50 \text{ (ASD)}$$

and

$$C_v = 1.0 \quad \text{(G2-2)}$$

User Note: All current ASTM A6 W, S and HP shapes except W44×230, W40×149, W36×135, W33×118, W30×90, W24×55, W16×26 and W12×14 meet the criteria stated in Section G2.1(a) for $F_y = 50$ ksi (345 MPa).

- (b) For webs of all other doubly symmetric shapes and singly symmetric shapes and channels, except round *HSS*, the web shear coefficient, C_v , is determined as follows:

- (i) When $h/t_w \leq 1.10\sqrt{k_v E / F_y}$

$$C_v = 1.0 \quad \text{(G2-3)}$$

- (ii) When $1.10\sqrt{k_v E / F_y} < h/t_w \leq 1.37\sqrt{k_v E / F_y}$

$$C_v = \frac{1.10\sqrt{k_v E / F_y}}{h/t_w} \quad \text{(G2-4)}$$

- (iii) When $h/t_w > 1.37\sqrt{k_v E / F_y}$

$$C_v = \frac{1.51k_v E}{(h/t_w)^2 F_y} \quad \text{(G2-5)}$$

where

A_w = area of web, the overall depth times the web thickness, dt_w , in.² (mm²)

h = for rolled shapes, the clear distance between flanges less the fillet or corner radii, in. (mm)

= for built-up welded sections, the clear distance between flanges, in. (mm)

= for built-up bolted sections, the distance between *fastener* lines, in. (mm)

= for tees, the overall depth, in. (mm)

t_w = thickness of web, in. (mm)

The web plate *shear buckling* coefficient, k_v , is determined as follows:

- (i) For webs without *transverse stiffeners* and with $h/t_w < 260$:

$$k_v = 5$$

except for the stem of tee shapes where $k_v = 1.2$.

(ii) For webs with transverse stiffeners:

$$k_v = 5 + \frac{5}{(a/h)^2} \quad (\text{G2-6})$$

$$= 5 \text{ when } a/h > 3.0 \text{ or } a/h > \left[\frac{260}{(h/t_w)} \right]^2$$

where

a = clear distance between transverse stiffeners, in. (mm)

User Note: For all ASTM A6 W, S, M and HP shapes except M12.5×12.4, M12.5×11.6, M12×11.8, M12×10.8, M12×10, M10×8 and M10×7.5, when $F_y = 50$ ksi (345 MPa), $C_v = 1.0$.

2. Transverse Stiffeners

Transverse stiffeners are not required where $h/t_w \leq 2.46\sqrt{E/F_y}$, or where the available shear strength provided in accordance with Section G2.1 for $k_v = 5$ is greater than the *required shear strength*.

The moment of inertia, I_{st} , of transverse stiffeners used to develop the available web shear strength, as provided in Section G2.1, about an axis in the web center for stiffener pairs or about the face in contact with the web plate for single stiffeners, shall meet the following requirement

$$I_{st} \geq bt_w^3 j \quad (\text{G2-7})$$

where

$$j = \frac{2.5}{(a/h)^2} - 2 \geq 0.5 \quad (\text{G2-8})$$

and b is the smaller of the dimensions a and h

Transverse stiffeners are permitted to be stopped short of the tension flange, provided *bearing* is not needed to transmit a concentrated *load* or reaction. The weld by which transverse stiffeners are attached to the web shall be terminated not less than four times nor more than six times the web thickness from the near toe of the web-to-flange weld. When single stiffeners are used, they shall be attached to the compression flange, if it consists of a rectangular plate, to resist any uplift tendency due to torsion in the flange.

Bolts connecting stiffeners to the girder web shall be spaced not more than 12 in. (305 mm) on center. If intermittent *fillet welds* are used, the clear distance between welds shall not be more than 16 times the web thickness nor more than 10 in. (250 mm).

G3. TENSION FIELD ACTION

1. Limits on the Use of Tension Field Action

Consideration of *tension field action* is permitted for flanged members when the web plate is supported on all four sides by flanges or *stiffeners*. Consideration of tension field action is not permitted:

- (a) for *end panels* in all members with *transverse stiffeners*;
- (b) when a/h exceeds 3.0 or $[260/(h/t_w)]^2$;
- (c) when $2A_w/(A_{fc} + A_{ft}) > 2.5$; or
- (d) when h/b_{fc} or $h/b_{ft} > 6.0$.

where

A_{fc} = area of compression flange, in.² (mm²)

A_{ft} = area of tension flange, in.² (mm²)

b_{fc} = width of compression flange, in. (mm)

b_{ft} = width of tension flange, in. (mm)

In these cases, the *nominal shear strength*, V_n , shall be determined according to the provisions of Section G2.

2. Shear Strength With Tension Field Action

When *tension field action* is permitted according to Section G3.1, the nominal shear strength, V_n , with tension field action, according to the *limit state* of tension field yielding, shall be

- (a) When $h/t_w \leq 1.10\sqrt{k_v E / F_y}$

$$V_n = 0.6F_y A_w \quad (\text{G3-1})$$

- (b) When $h/t_w > 1.10\sqrt{k_v E / F_y}$

$$V_n = 0.6F_y A_w \left(C_v + \frac{1 - C_v}{1.15\sqrt{1 + (a/h)^2}} \right) \quad (\text{G3-2})$$

where

k_v and C_v are as defined in Section G2.1

3. Transverse Stiffeners

Transverse stiffeners subject to *tension field action* shall meet the requirements of Section G2.2 and the following limitations:

$$(1) (b/t)_{st} \leq 0.56\sqrt{\frac{E}{F_{yst}}} \quad (\text{G3-3})$$

$$(2) I_{st} \geq I_{st1} + (I_{st2} - I_{st1}) \left[\frac{V_r - V_{c1}}{V_{c2} - V_{c1}} \right] \quad (\text{G3-4})$$

where

$(b/t)_{st}$ = width-to-thickness ratio of the *stiffener*

F_{yst} = *specified minimum yield stress* of the stiffener material, ksi (MPa)

I_{st} = moment of inertia of the transverse stiffeners about an axis in the web center for stiffener pairs, or about the face in contact with the web plate for single stiffeners, in.⁴ (mm⁴)

I_{st1} = minimum moment of inertia of the transverse stiffeners required for development of the web *shear buckling* resistance in Section G2.2, in.⁴ (mm⁴)

I_{st2} = minimum moment of inertia of the transverse stiffeners required for development of the full web shear buckling plus the web tension field resistance, $V_r = V_{c2}$, in.⁴ (mm⁴)

$$= \frac{h^4 \rho_{st}^{1.3} \left(\frac{F_{yw}}{E} \right)^{1.5}}{40} \quad (G3-5)$$

V_r = larger of the *required shear strengths* in the adjacent web panels using *LRFD* or *ASD load combinations*, kips (N)

V_{c1} = smaller of the *available shear strengths in the adjacent web panels* with V_n as defined in Section G2.1, kips (N)

V_{c2} = smaller of the *available shear strengths* in the adjacent web panels with V_n as defined in Section G3.2, kips (N)

ρ_{st} = the larger of F_{yw}/F_{yst} and 1.0

F_{yw} = *specified minimum yield stress* of the web material, ksi (MPa)

G4. SINGLE ANGLES

The nominal shear strength, V_n , of a single angle leg shall be determined using Equation G2-1 and Section G2.1(b) with $A_w = bt$

where

b = width of the leg resisting the shear *force*, in. (mm)

t = thickness of angle leg, in. (mm)

$h/t_w = b/t$

$k_v = 1.2$

G5. RECTANGULAR HSS AND BOX-SHAPED MEMBERS

The *nominal shear strength*, V_n , of rectangular *HSS* and box members shall be determined using the provisions of Section G2.1 with $A_w = 2ht$

where

h = width resisting the shear *force*, taken as the clear distance between the flanges less the inside corner radius on each side, in. (mm)

t = *design wall thickness*, equal to 0.93 times the nominal wall thickness for electric-resistance-welded (ERW) HSS and equal to the nominal thickness for submerged-arc-welded (SAW) HSS, in. (mm)

$t_w = t$, in. (mm)

$k_v = 5$

If the corner radius is not known, h shall be taken as the corresponding outside dimension minus 3 times the thickness.

G6. ROUND HSS

The *nominal shear strength*, V_n , of round HSS, according to the *limit states of shear yielding* and *shear buckling*, shall be determined as:

$$V_n = F_{cr}A_g/2 \quad (\text{G6-1})$$

where

F_{cr} shall be the larger of

$$F_{cr} = \frac{1.60E}{\sqrt{\frac{L_v}{D} \left(\frac{D}{t}\right)^4}} \quad (\text{G6-2a})$$

and

$$F_{cr} = \frac{0.78E}{\left(\frac{D}{t}\right)^2} \quad (\text{G6-2b})$$

but shall not exceed $0.6F_y$

A_g = gross cross-sectional area of member, in.² (mm²)

D = outside diameter, in. (mm)

L_v = distance from maximum to zero shear *force*, in. (mm)

t = *design wall thickness*, equal to 0.93 times the nominal wall thickness for ERW HSS and equal to the nominal thickness for SAW HSS, in. (mm)

User Note: The shear buckling equations, Equations G6-2a and G6-2b, will control for D/t over 100, high-strength steels, and long lengths. For standard sections, shear yielding will usually control.

G7. WEAK AXIS SHEAR IN DOUBLY SYMMETRIC AND SINGLY SYMMETRIC SHAPES

For doubly and singly symmetric shapes loaded in the *weak axis* without torsion, the nominal shear strength, V_n , for each shear resisting element shall be determined using Equation G2-1 and Section G2.1(b) with $A_w = b_f t_f$, $h/t_w = b/t_f$, $k_v = 1.2$, and

b = for flanges of I-shaped members, half the full-flange width, b_f ; for flanges of channels, the full *nominal dimension* of the flange, in. (mm)

User Note: For all ASTM A6 W, S, M and HP shapes, when $F_y \leq 50$ ksi (345 MPa), $C_v = 1.0$.

G8. BEAMS AND GIRDERS WITH WEB OPENINGS

The effect of all web openings on the shear strength of steel and *composite beams* shall be determined. Adequate reinforcement shall be provided when the *required strength* exceeds the *available strength* of the member at the opening.

CHAPTER H

DESIGN OF MEMBERS FOR COMBINED FORCES AND TORSION

This chapter addresses members subject to axial *force* and flexure about one or both axes, with or without torsion, and members subject to torsion only.

The chapter is organized as follows:

- H1. Doubly and Singly Symmetric Members Subject to Flexure and Axial Force
- H2. Unsymmetric and Other Members Subject to Flexure and Axial Force
- H3. Members Subject to Torsion and Combined Torsion, Flexure, Shear and/or Axial Force
- H4. Rupture of Flanges with Holes Subject to Tension

User Note: For *composite* members, see Chapter I.

H1. DOUBLY AND SINGLY SYMMETRIC MEMBERS SUBJECT TO FLEXURE AND AXIAL FORCE

1. Doubly and Singly Symmetric Members Subject to Flexure and Compression

The interaction of flexure and compression in doubly symmetric members and singly symmetric members for which $0.1 \leq (I_{yc}/I_y) \leq 0.9$, constrained to bend about a *geometric axis* (x and/or y) shall be limited by Equations H1-1a and H1-1b, where I_{yc} is the moment of inertia of the compression flange about the y -axis, in.⁴ (mm⁴).

User Note: Section H2 is permitted to be used in lieu of the provisions of this section.

(a) When $\frac{P_r}{P_c} \geq 0.2$

$$\frac{P_r}{P_c} + \frac{8}{9} \left(\frac{M_{rx}}{M_{cx}} + \frac{M_{ry}}{M_{cy}} \right) \leq 1.0 \quad (\text{H1-1a})$$

(b) When $\frac{P_r}{P_c} < 0.2$

$$\frac{P_r}{2P_c} + \left(\frac{M_{rx}}{M_{cx}} + \frac{M_{ry}}{M_{cy}} \right) \leq 1.0 \quad (\text{H1-1b})$$

where

P_r = required axial strength using LRFD or ASD load combinations, kips (N)

P_c = available axial strength, kips (N)

M_r = required flexural strength using LRFD or ASD load combinations, kip-in. (N-mm)

M_c = available flexural strength, kip-in. (N-mm)

x = subscript relating symbol to *strong axis* bending

y = subscript relating symbol to *weak axis* bending

For design according to Section B3.3 (LRFD):

P_r = required axial strength using LRFD load combinations, kips (N)

$P_c = \phi_c P_n$ = design axial strength, determined in accordance with Chapter E, kips (N)

M_r = required flexural strength using LRFD load combinations, kip-in. (N-mm)

$M_c = \phi_b M_n$ = design flexural strength determined in accordance with Chapter F, kip-in. (N-mm)

ϕ_c = resistance factor for compression = 0.90

ϕ_b = resistance factor for flexure = 0.90

For design according to Section B3.4 (ASD):

P_r = required axial strength using ASD load combinations, kips (N)

$P_c = P_n / \Omega_c$ = allowable axial strength, determined in accordance with Chapter E, kips (N)

M_r = required flexural strength using ASD load combinations, kip-in. (N-mm)

$M_c = M_n / \Omega_b$ = allowable flexural strength determined in accordance with Chapter F, kip-in. (N-mm)

Ω_c = safety factor for compression = 1.67

Ω_b = safety factor for flexure = 1.67

2. Doubly and Singly Symmetric Members Subject to Flexure and Tension

The interaction of flexure and tension in doubly symmetric members and singly symmetric members constrained to bend about a *geometric axis* (x and/or y) shall be limited by Equations H1-1a and H1-1b

where

For design according to Section B3.3 (LRFD):

P_r = required axial strength using LRFD load combinations, kips (N)

$P_c = \phi_t P_n$ = design axial strength, determined in accordance with Section D2, kips (N)

M_r = required flexural strength using LRFD load combinations, kip-in. (N-mm)

$M_c = \phi_b M_n$ = design flexural strength determined in accordance with Chapter F, kip-in. (N-mm)

ϕ_t = resistance factor for tension (see Section D2)

ϕ_b = resistance factor for flexure = 0.90

For design according to Section B3.4 (ASD):

P_r = required axial strength using ASD load combinations, kips (N)

$P_c = P_n / \Omega_t$ = allowable axial strength, determined in accordance with Section D2, kips (N)

M_r = required flexural strength using ASD load combinations, kip-in. (N-mm)

$M_c = M_n/\Omega_b$ = allowable flexural strength determined in accordance with Chapter F, kip-in. (N-mm)

Ω_t = safety factor for tension (see Section D2)

Ω_b = safety factor for flexure = 1.67

For doubly symmetric members, C_b in Chapter F may be multiplied by $\sqrt{1 + \frac{\alpha P_r}{P_{ey}}}$ for axial tension that acts concurrently with flexure

where

$$P_{ey} = \frac{\pi^2 EI_y}{L_b^2}$$

and

$$\alpha = 1.0 \text{ (LRFD)}; \alpha = 1.6 \text{ (ASD)}$$

A more detailed analysis of the interaction of flexure and tension is permitted in lieu of Equations H1-1a and H1-1b.

3. Doubly Symmetric Rolled Compact Members Subject to Single Axis Flexure and Compression

For doubly symmetric rolled compact members with $(KL)_z \leq (KL)_y$ subjected to flexure and compression with moments primarily about their major axis, it is permissible to consider the two independent *limit states*, *in-plane instability* and *out-of-plane buckling* or *lateral-torsional buckling*, separately in lieu of the combined approach provided in Section H1.1.

For members with $M_{ry}/M_{cy} \geq 0.05$, the provisions of Section H1.1 shall be followed.

- (a) For the limit state of in-plane instability, Equations H1-1 shall be used with P_c , M_{rx} and M_{cx} determined in the plane of bending.
- (b) For the limit state of out-of-plane buckling and lateral-torsional buckling:

$$\frac{P_r}{P_{cy}} \left(1.5 - 0.5 \frac{P_r}{P_{cy}} \right) + \left(\frac{M_{rx}}{C_b M_{cx}} \right)^2 \leq 1.0 \quad (\text{H1-2})$$

where

P_{cy} = available compressive strength out of the plane of bending, kips (N)

C_b = lateral-torsional buckling modification factor determined from Section F1

M_{cx} = available lateral-torsional strength for *strong axis* flexure determined in accordance with Chapter F using $C_b = 1.0$, kip-in. (N-mm)

User Note: In Equation H1-2, $C_b M_{cx}$ may be larger than $\phi_b M_{px}$ in LRFD or M_{px}/Ω_b in ASD. The yielding resistance of the *beam-column* is captured by Equations H1-1.

H2. UNSYMMETRIC AND OTHER MEMBERS SUBJECT TO FLEXURE AND AXIAL FORCE

This section addresses the interaction of flexure and axial *stress* for shapes not covered in Section H1. It is permitted to use the provisions of this Section for any shape in lieu of the provisions of Section H1.

$$\left| \frac{f_{ra}}{F_{ca}} + \frac{f_{rbw}}{F_{cbw}} + \frac{f_{rbz}}{F_{cbz}} \right| \leq 1.0 \quad (\text{H2-1})$$

where

- f_{ra} = required axial stress at the point of consideration using LRFD or ASD load combinations, ksi (MPa)
- F_{ca} = available axial stress at the point of consideration, ksi (MPa)
- f_{rbw}, f_{rbz} = required flexural stress at the point of consideration using LRFD or ASD load combinations, ksi (MPa)
- F_{cbw}, F_{cbz} = available flexural stress at the point of consideration, ksi (MPa)
- w = subscript relating symbol to major principal axis bending
- z = subscript relating symbol to minor principal axis bending

For design according to Section B3.3 (LRFD):

- f_{ra} = required axial stress at the point of consideration using LRFD load combinations, ksi (MPa)
- F_{ca} = $\phi_c F_{cr}$ = design axial stress, determined in accordance with Chapter E for compression or Section D2 for tension, ksi (MPa)
- f_{rbw}, f_{rbz} = required flexural stress at the point of consideration using LRFD or ASD load combinations, ksi (MPa)
- $F_{cbw}, F_{cbz} = \frac{\phi_b M_n}{S}$ = design flexural stress determined in accordance with Chapter F, ksi (MPa). Use the section modulus for the specific location in the cross section and consider the sign of the stress.
- ϕ_c = resistance factor for compression = 0.90
- ϕ_t = resistance factor for tension (Section D2)
- ϕ_b = resistance factor for flexure = 0.90

For design according to Section B3.4 (ASD):

- f_{ra} = required axial stress at the point of consideration using ASD load combinations, ksi (MPa)
- $F_{ca} = \frac{F_{cr}}{\Omega_c}$ = allowable axial stress determined in accordance with Chapter E for compression, or Section D2 for tension, ksi (MPa)
- f_{rbw}, f_{rbz} = required flexural stress at the point of consideration using LRFD or ASD load combinations, ksi (MPa)
- $F_{cbw}, F_{cbz} = \frac{M_n}{\Omega_b S}$ = allowable flexural stress determined in accordance with Chapter F, ksi (MPa). Use the section modulus for the specific location in the cross section and consider the sign of the stress.
- Ω_c = safety factor for compression = 1.67

$$\begin{aligned}\Omega_t &= \text{safety factor for tension (see Section D2)} \\ \Omega_b &= \text{safety factor for flexure} = 1.67\end{aligned}$$

Equation H2-1 shall be evaluated using the principal bending axes by considering the sense of the flexural stresses at the critical points of the cross section. The flexural terms are either added to or subtracted from the axial term as appropriate. When the axial force is compression, *second order effects* shall be included according to the provisions of Chapter C.

A more detailed analysis of the interaction of flexure and tension is permitted in lieu of Equation H2-1.

H3. MEMBERS SUBJECT TO TORSION AND COMBINED TORSION, FLEXURE, SHEAR AND/OR AXIAL FORCE

1. Round and Rectangular HSS Subject to Torsion

The *design torsional strength*, $\phi_T T_n$, and the *allowable torsional strength*, T_n/Ω_T , for round and rectangular HSS according to the *limit states of torsional yielding and torsional buckling* shall be determined as follows:

$$\begin{aligned}\phi_T &= 0.90 \text{ (LRFD)} & \Omega_T &= 1.67 \text{ (ASD)} \\ T_n &= F_{cr} C\end{aligned}\tag{H3-1}$$

where

C is the HSS torsional constant

The critical *stress*, F_{cr} , shall be determined as follows:

(a) For round HSS, F_{cr} shall be the larger of

$$(i) \quad F_{cr} = \frac{1.23E}{\sqrt{\frac{L}{D} \left(\frac{D}{t}\right)^4}}\tag{H3-2a}$$

and

$$(ii) \quad F_{cr} = \frac{0.60E}{\left(\frac{D}{t}\right)^2}\tag{H3-2b}$$

but shall not exceed $0.6F_y$,

where

L = length of the member, in. (mm)

D = outside diameter, in. (mm)

(b) For rectangular HSS

(i) When $h/t \leq 2.45\sqrt{E/F_y}$

$$F_{cr} = 0.6F_y \quad (\text{H3-3})$$

$$\text{(ii) When } 2.45\sqrt{\frac{E}{F_y}} < h/t \leq 3.07\sqrt{\frac{E}{F_y}}$$

$$F_{cr} = \frac{0.6F_y(2.45\sqrt{E/F_y})}{\left(\frac{h}{t}\right)} \quad (\text{H3-4})$$

$$\text{(iii) When } 3.07\sqrt{\frac{E}{F_y}} < h/t \leq 260$$

$$F_{cr} = \frac{0.458\pi^2 E}{\left(\frac{h}{t}\right)^2} \quad (\text{H3-5})$$

where

h = flat width of longer side as defined in Section B4.1b(d), in. (mm)

t = design wall thickness defined in Section B4.2, in. (mm)

User Note: The torsional constant, C , may be conservatively taken as:

$$\text{For round HSS: } C = \frac{\pi(D-t)^2 t}{2}$$

$$\text{For rectangular HSS: } C = 2(B-t)(H-t)t - 4.5(4-\pi)t^3$$

2. HSS Subject to Combined Torsion, Shear, Flexure and Axial Force

When the *required torsional strength*, T_r , is less than or equal to 20% of the *available torsional strength*, T_c , the interaction of torsion, shear, flexure and/or axial force for HSS shall be determined by Section H1 and the torsional effects shall be neglected. When T_r exceeds 20% of T_c , the interaction of torsion, shear, flexure and/or axial force shall be limited, at the point of consideration, by

$$\left(\frac{P_r}{P_c} + \frac{M_r}{M_c}\right) + \left(\frac{V_r}{V_c} + \frac{T_r}{T_c}\right)^2 \leq 1.0 \quad (\text{H3-6})$$

where

For design according to Section B3.3 (LRFD):

P_r = required axial strength using LRFD load combinations, kips (N)

$P_c = \phi P_n$ = design tensile or compressive strength in accordance with Chapter D or E, kips (N)

M_r = required flexural strength using LRFD load combinations, kip-in. (N-mm)

$M_c = \phi_b M_n$ = design flexural strength in accordance with Chapter F, kip-in. (N-mm)

V_r = required shear strength using LRFD load combinations, kips (N)

$V_c = \phi_v V_n = \text{design shear strength}$ in accordance with Chapter G, kips (N)

$T_r =$ required torsional strength using LRFD load combinations, kip-in. (N-mm)

$T_c = \phi_T T_n = \text{design torsional strength}$ in accordance with Section H3.1, kip-in. (N-mm)

For design according to Section B3.4 (ASD):

$P_r =$ required axial strength using *ASD load combinations*, kips (N)

$P_c = P_n/\Omega = \text{allowable tensile or compressive strength}$ in accordance with Chapter D or E, kips (N)

$M_r =$ required flexural strength using ASD load combinations, kip-in. (N-mm)

$M_c = M_n/\Omega_b = \text{allowable flexural strength}$ in accordance with Chapter F, kip-in. (N-mm)

$V_r =$ required shear strength using ASD load combinations, kips (N)

$V_c = V_n/\Omega_v = \text{allowable shear strength}$ in accordance with Chapter G, kips (N)

$T_r =$ required torsional strength using ASD load combinations, kip-in. (N-mm)

$T_c = T_n/\Omega_T = \text{allowable torsional strength}$ in accordance with Section H3.1, kip-in. (N-mm)

3. Non-HSS Members Subject to Torsion and Combined Stress

The *available torsional strength* for non-HSS members shall be the lowest value obtained according to the *limit states* of *yielding* under normal stress, *shear yielding* under shear stress, or *buckling*, determined as follows:

$$\phi_T = 0.90 \text{ (LRFD)} \quad \Omega_T = 1.67 \text{ (ASD)}$$

(a) For the limit state of yielding under normal stress

$$F_n = F_y \quad (\text{H3-7})$$

(b) For the limit state of shear yielding under shear stress

$$F_n = 0.6F_y \quad (\text{H3-8})$$

(c) For the limit state of buckling

$$F_n = F_{cr} \quad (\text{H3-9})$$

where

$F_{cr} =$ buckling stress for the section as determined by analysis, ksi (MPa)

Some constrained *local yielding* is permitted adjacent to areas that remain elastic.

H4. RUPTURE OF FLANGES WITH HOLES SUBJECT TO TENSION

At locations of bolt holes in flanges subject to tension under combined axial force and major axis flexure, flange *tensile rupture strength* shall be limited by Equation H4-1. Each flange subject to tension due to axial force and flexure shall be checked separately.

$$\frac{P_r}{P_c} + \frac{M_{rx}}{M_{cx}} \leq 1.0 \quad (\text{H4-1})$$

where

P_r = required axial strength of the member at the location of the bolt holes, positive in tension, negative in compression, kips (N)

P_c = available axial strength for the *limit state* of tensile rupture of the net section at the location of bolt holes, kips (N)

M_{rx} = required flexural strength at the location of the bolt holes; positive for tension in the flange under consideration, negative for compression, kip-in. (N-mm)

M_{cx} = available flexural strength about x -axis for the limit state of tensile rupture of the flange, determined according to Section F13.1. When the limit state of tensile rupture in flexure does not apply, use the plastic bending moment, M_p , determined with bolt holes not taken into consideration, kip-in. (N-mm)

For design according to Section B3.3 (LRFD):

P_r = required axial strength using *LRFD load combinations*, kips (N)

$P_c = \phi_t P_n$ = design axial strength for the limit state of tensile rupture, determined in accordance with Section D2(b), kips (N)

M_{rx} = required flexural strength using LRFD load combinations, kip-in. (N-mm)

$M_{cx} = \phi_b M_n$ = design flexural strength determined in accordance with Section F13.1 or the plastic bending moment, M_p , determined with bolt holes not taken into consideration, as applicable, kip-in. (N-mm)

ϕ_t = *resistance factor* for tensile rupture = 0.75

ϕ_b = resistance factor for flexure = 0.90

For design according to Section B3.4 (ASD):

P_r = required axial strength using *ASD load combinations*, kips (N)

$P_c = \frac{P_n}{\Omega_t}$ = allowable axial strength for the limit state of tensile rupture, determined in accordance with Section D2(b), kips (N)

M_{rx} = required flexural strength using ASD load combinations, kip-in. (N-mm)

$M_{cx} = \frac{M_n}{\Omega_b}$ = allowable flexural strength determined in accordance with Section F13.1, or the plastic bending moment, M_p , determined with bolt holes not taken into consideration, as applicable, kip-in. (N-mm)

Ω_t = *safety factor* for tensile rupture = 2.00

Ω_b = safety factor for flexure = 1.67

CHAPTER I

DESIGN OF COMPOSITE MEMBERS

This chapter addresses *composite* members composed of rolled or built-up *structural steel* shapes or *HSS* and structural concrete acting together, and steel *beams* supporting a reinforced concrete slab so interconnected that the beams and the slab act together to resist bending. Simple and continuous *composite beams* with *steel headed stud anchors*, *concrete-encased*, and *concrete filled beams*, constructed with or without temporary shores, are included.

The chapter is organized as follows:

- I1. General Provisions
- I2. Axial Force
- I3. Flexure
- I4. Shear
- I5. Combined Axial Force and Flexure
- I6. Load Transfer
- I7. Composite Diaphragms and Collector Beams
- I8. Steel Anchors
- I9. Special Cases

I1. GENERAL PROVISIONS

In determining *load effects* in members and *connections* of a structure that includes *composite* members, consideration shall be given to the effective sections at the time each increment of *load* is applied.

1. Concrete and Steel Reinforcement

The design, detailing and material properties related to the concrete and reinforcing steel portions of composite construction shall comply with the reinforced concrete and reinforcing bar design *specifications* stipulated by the *applicable building code*. Additionally, the provisions in ACI 318 shall apply with the following exceptions and limitations:

- (1) ACI 318 Sections 7.8.2 and 10.13, and Chapter 21 shall be excluded in their entirety.
- (2) Concrete and steel reinforcement material limitations shall be as specified in Section I1.3.
- (3) *Transverse reinforcement* limitations shall be as specified in Section I2.1a(2), in addition to those specified in ACI 318.
- (4) The minimum longitudinal reinforcing ratio for *encased composite members* shall be as specified in Section I2.1a(3).

Concrete and steel reinforcement components designed in accordance with ACI 318 shall be based on a level of loading corresponding to *LRFD load combinations*.

User Note: It is the intent of the Specification that the concrete and reinforcing steel portions of composite concrete members be detailed utilizing the noncomposite provisions of ACI 318 as modified by the Specification. All requirements specific to composite members are covered in the Specification.

Note that the design basis for ACI 318 is strength design. Designers using ASD for steel must be conscious of the different *load factors*.

2. Nominal Strength of Composite Sections

The *nominal strength* of composite sections shall be determined in accordance with the *plastic stress distribution method* or the *strain compatibility method* as defined in this section.

The *tensile strength* of the concrete shall be neglected in the determination of the nominal strength of composite members.

Local buckling effects shall be considered for *filled composite members* as defined in Section 11.4. Local buckling effects need not be considered for *encased composite members*.

2a. Plastic Stress Distribution Method

For the *plastic stress distribution method*, the *nominal strength* shall be computed assuming that steel components have reached a *stress* of F_y in either tension or compression and concrete components in compression due to axial force and/or flexure have reached a stress of $0.85f'_c$. For round *HSS* filled with concrete, a stress of $0.95f'_c$ is permitted to be used for concrete components in compression due to axial force and/or flexure to account for the effects of concrete confinement.

2b. Strain Compatibility Method

For the *strain compatibility method*, a linear distribution of strains across the section shall be assumed, with the maximum concrete compressive strain equal to 0.003 in./in. (mm/mm). The stress-strain relationships for steel and concrete shall be obtained from tests or from published results for similar materials.

User Note: The strain compatibility method should be used to determine *nominal strength* for irregular sections and for cases where the steel does not exhibit elasto-plastic behavior. General guidelines for the strain compatibility method for encased members subjected to axial *load*, flexure or both are given in AISC Design Guide 6 and ACI 318.

3. Material Limitations

For concrete, *structural steel*, and steel reinforcing bars in composite systems, the following limitations shall be met, unless justified by testing or analysis:

- (1) For the determination of the *available strength*, concrete shall have a compressive strength, f'_c , of not less than 3 ksi (21 MPa) nor more than 10 ksi (70 MPa) for normal weight concrete and not less than 3 ksi (21 MPa) nor more than 6 ksi (42 MPa) for *lightweight concrete*.

User Note: Higher strength concrete material properties may be used for *stiffness* calculations but may not be relied upon for strength calculations unless justified by testing or analysis.

- (2) The *specified minimum yield stress* of structural steel and reinforcing bars used in calculating the strength of composite members shall not exceed 75 ksi (525 MPa).

4. Classification of Filled Composite Sections for Local Buckling

For compression, filled composite sections are classified as compact, noncompact or slender. For a section to qualify as compact, the maximum width-to-thickness ratio of its compression steel elements shall not exceed the limiting width-to-thickness ratio, λ_p , from Table I1.1a. If the maximum width-to-thickness ratio of one or more steel compression elements exceeds λ_p , but does not exceed λ_r from Table I1.1a, the filled composite section is noncompact. If the maximum width-to-thickness ratio of any compression steel element exceeds λ_r , the section is slender. The maximum permitted width-to-thickness ratio shall be as specified in the table.

For flexure, filled composite sections are classified as compact, noncompact or slender. For a section to qualify as compact, the maximum width-to-thickness ratio of its compression steel elements shall not exceed the limiting width-to-thickness ratio, λ_p , from Table I1.1b. If the maximum width-to-thickness ratio of one or more steel compression elements exceeds λ_p , but does not exceed λ_r from Table I1.1b, the section is noncompact. If the width-to-thickness ratio of any steel element exceeds λ_r , the section is slender. The maximum permitted width-to-thickness ratio shall be as specified in the table.

Refer to Table B4.1a and Table B4.1b for definitions of width (b and D) and thickness (t) for rectangular and round *HSS* sections.

User Note: All current ASTM A500 Grade B square *HSS* sections are compact according to the limits of Table I1.1a and Table I1.1b except $\text{HSS}7\times7\times\frac{1}{8}$, $\text{HSS}8\times8\times\frac{1}{8}$, $\text{HSS}9\times9\times\frac{1}{8}$ and $\text{HSS}12\times12\times\frac{3}{16}$ which are noncompact for both axial compression and flexure.

All current ASTM A500 Grade B round *HSS* sections are compact according to the limits of Table I1.1a and Table I1.1b for both axial compression and flexure with the exception of $\text{HSS}16.0\times0.25$, which is noncompact for flexure.

TABLE I1.1A
Limiting Width-to-Thickness Ratios for
Compression Steel Elements in Composite
Members Subject to Axial Compression
For Use with Section I2.2

Description of Element	Width-to-Thickness Ratio	λ_p Compact/ Noncompact	λ_r Noncompact/ Slender	Maximum Permitted
Walls of Rectangular HSS and Boxes of Uniform Thickness	b/t	$2.26\sqrt{\frac{E}{F_y}}$	$3.00\sqrt{\frac{E}{F_y}}$	$5.00\sqrt{\frac{E}{F_y}}$
Round HSS	D/t	$\frac{0.15E}{F_y}$	$\frac{0.19E}{F_y}$	$\frac{0.31E}{F_y}$

TABLE I1.1B
Limiting Width-to-Thickness Ratios for
Compression Steel Elements in Composite
Members Subject to Flexure
For Use with Section I3.4

Description of Element	Width-to-Thickness Ratio	λ_p Compact/ Noncompact	λ_r Noncompact/ Slender	Maximum Permitted
Flanges of Rectangular HSS and Boxes of Uniform Thickness	b/t	$2.26\sqrt{\frac{E}{F_y}}$	$3.00\sqrt{\frac{E}{F_y}}$	$5.00\sqrt{\frac{E}{F_y}}$
Webs of Rectangular HSS and Boxes of Uniform Thickness	h/t	$3.00\sqrt{\frac{E}{F_y}}$	$5.70\sqrt{\frac{E}{F_y}}$	$5.70\sqrt{\frac{E}{F_y}}$
Round HSS	D/t	$\frac{0.09E}{F_y}$	$\frac{0.31E}{F_y}$	$\frac{0.31E}{F_y}$

12. AXIAL FORCE

This section applies to two types of *composite* members subject to axial force: *encased composite members* and *filled composite members*.

1. Encased Composite Members

1a. Limitations

For *encased composite members*, the following limitations shall be met:

- (1) The cross-sectional area of the steel core shall comprise at least 1% of the total composite cross section.
- (2) Concrete encasement of the steel core shall be reinforced with continuous longitudinal bars and lateral ties or spirals.

Where lateral ties are used, a minimum of either a No. 3 (10 mm) bar spaced at a maximum of 12 in. (305 mm) on center, or a No. 4 (13 mm) bar or larger spaced at a maximum of 16 in. (406 mm) on center shall be used. Deformed wire or welded wire reinforcement of equivalent area are permitted.

Maximum spacing of lateral ties shall not exceed 0.5 times the least *column* dimension.

- (3) The minimum reinforcement ratio for continuous longitudinal reinforcing, ρ_{sr} , shall be 0.004, where ρ_{sr} is given by:

$$\rho_{sr} = \frac{A_{sr}}{A_g} \quad (I2-1)$$

where

A_g = gross area of composite member, in.² (mm²)

A_{sr} = area of continuous reinforcing bars, in.² (mm²)

User Note: Refer to Sections 7.10 and 10.9.3 of ACI 318 for additional tie and spiral reinforcing provisions.

1b. Compressive Strength

The *design compressive strength*, $\phi_c P_n$, and *allowable compressive strength*, P_n/Ω_c , of doubly symmetric axially loaded *encased composite members* shall be determined for the *limit state of flexural buckling* based on member slenderness as follows:

$$\phi_c = 0.75 \text{ (LRFD)} \quad \Omega_c = 2.00 \text{ (ASD)}$$

- (a) When $\frac{P_{no}}{P_e} \leq 2.25$

$$P_n = P_{no} \left[0.658 \frac{P_{no}}{P_e} \right] \quad (I2-2)$$

- (b) When $\frac{P_{no}}{P_e} > 2.25$

$$P_n = 0.877P_e \quad (12-3)$$

where

$$P_{no} = F_y A_s + F_{ysr} A_{sr} + 0.85 f'_c A_c \quad (12-4)$$

$$P_e = \text{elastic critical buckling load determined in accordance with Chapter C or Appendix 7, kips (N)} \\ = \pi^2 (EI_{eff}) / (KL)^2 \quad (12-5)$$

$$A_c = \text{area of concrete, in.}^2 \text{ (mm}^2\text{)}$$

$$A_s = \text{area of the steel section, in.}^2 \text{ (mm}^2\text{)}$$

$$E_c = \text{modulus of elasticity of concrete}$$

$$= w_c^{1.5} \sqrt{f'_c}, \text{ ksi } \left(0.043 w_c^{1.5} \sqrt{f'_c}, \text{ MPa} \right)$$

$$EI_{eff} = \text{effective stiffness of composite section, kip-in.}^2 \text{ (N-mm}^2\text{)}$$

$$= E_s I_s + 0.5 E_s I_{sr} + C_1 E_c I_c \quad (12-6)$$

$$C_1 = \text{coefficient for calculation of effective rigidity of an encased composite compression member}$$

$$= 0.1 + 2 \left(\frac{A_s}{A_c + A_s} \right) \leq 0.3 \quad (12-7)$$

$$E_s = \text{modulus of elasticity of steel}$$

$$= 29,000 \text{ ksi (200 000 MPa)}$$

$$F_y = \text{specified minimum yield stress of steel section, ksi (MPa)}$$

$$F_{ysr} = \text{specified minimum yield stress of reinforcing bars, ksi (MPa)}$$

$$I_c = \text{moment of inertia of the concrete section about the elastic neutral axis of the composite section, in.}^4 \text{ (mm}^4\text{)}$$

$$I_s = \text{moment of inertia of steel shape about the elastic neutral axis of the composite section, in.}^4 \text{ (mm}^4\text{)}$$

$$I_{sr} = \text{moment of inertia of reinforcing bars about the elastic neutral axis of the composite section, in.}^4 \text{ (mm}^4\text{)}$$

$$K = \text{effective length factor}$$

$$L = \text{laterally unbraced length of the member, in. (mm)}$$

$$f'_c = \text{specified compressive strength of concrete, ksi (MPa)}$$

$$w_c = \text{weight of concrete per unit volume } (90 \leq w_c \leq 155 \text{ lbs/ft}^3 \text{ or } 1500 \leq w_c \leq 2500 \text{ kg/m}^3)$$

The *available compressive strength* need not be less than that specified for the bare steel member as required by Chapter E.

1c. Tensile Strength

The *available tensile strength* of axially loaded *encased composite members* shall be determined for the limit state of *yielding* as follows:

$$P_n = F_y A_s + F_{ysr} A_{sr} \quad (12-8)$$

$$\phi_t = 0.90 \text{ (LRFD)} \quad \Omega_t = 1.67 \text{ (ASD)}$$

1d. Load Transfer

Load transfer requirements for encased composite members shall be determined in accordance with Section I6.

1e. Detailing Requirements

Clear spacing between the steel core and longitudinal reinforcing shall be a minimum of 1.5 reinforcing bar diameters, but not less than 1.5 in. (38 mm).

If the composite cross section is built up from two or more encased steel shapes, the shapes shall be interconnected with *lacing*, *tie plates*, *batten plates* or similar components to prevent *buckling* of individual shapes due to *loads* applied prior to hardening of the concrete.

2. Filled Composite Members

2a. Limitations

For *filled composite members*, the cross-sectional area of the steel section shall comprise at least 1% of the total composite cross section.

Filled composite members shall be classified for *local buckling* according to Section II.4.

2b. Compressive Strength

The *available compressive strength* of axially loaded doubly symmetric *filled composite members* shall be determined for the limit state of *flexural buckling* in accordance with Section I2.1b with the following modifications:

(a) For *compact sections*

$$P_{no} = P_p \quad (I2-9a)$$

where

$$P_p = F_y A_s + C_2 f'_c \left(A_c + A_{sr} \frac{E_s}{E_c} \right) \quad (I2-9b)$$

$C_2 = 0.85$ for rectangular sections and 0.95 for round sections

(b) For *noncompact sections*

$$P_{no} = P_p - \frac{P_p - P_y}{(\lambda_r - \lambda_p)^2} (\lambda - \lambda_p)^2 \quad (I2-9c)$$

where

λ , λ_p and λ_r are slenderness ratios determined from Table II.1a

P_p is determined from Equation I2-9b

$$P_y = F_y A_s + 0.7 f'_c \left(A_c + A_{sr} \frac{E_s}{E_c} \right) \quad (I2-9d)$$

(c) For slender sections

$$P_{no} = F_{cr} A_s + 0.7 f'_c \left(A_c + A_{sr} \frac{E_s}{E_c} \right) \quad (I2-9e)$$

where

(i) For rectangular filled sections

$$F_{cr} = \frac{9E_s}{\left(\frac{b}{t}\right)^2} \quad (\text{I2-10})$$

(ii) For round filled sections

$$F_{cr} = \frac{0.72F_y}{\left(\left(\frac{D}{t}\right)\frac{F_y}{E_s}\right)^{0.2}} \quad (\text{I2-11})$$

The effective stiffness of the composite section, EI_{eff} , for all sections shall be:

$$EI_{eff} = E_s I_s + E_s I_{sr} + C_3 E_c I_c \quad (\text{I2-12})$$

where

C_3 = coefficient for calculation of effective rigidity of filled composite compression member

$$= 0.6 + 2 \left[\frac{A_s}{A_c + A_s} \right] \leq 0.9 \quad (\text{I2-13})$$

The available compressive *strength* need not be less than specified for the bare steel member as required by Chapter E.

2c. Tensile Strength

The *available tensile strength* of axially loaded *filled composite members* shall be determined for the limit state of *yielding* as follows:

$$P_n = A_s F_y + A_{sr} F_{ysr} \quad (\text{I2-14})$$

$$\phi_t = 0.90 \text{ (LRFD)} \quad \Omega_t = 1.67 \text{ (ASD)}$$

2d. Load Transfer

Load transfer requirements for filled composite members shall be determined in accordance with Section I6.

I3. FLEXURE

This section applies to three types of *composite members* subject to flexure: *composite beams with steel anchors* consisting of steel headed stud anchors or steel channel anchors, *encased composite members*, and *filled composite members*.

1. General

1a. Effective Width

The *effective width* of the concrete slab shall be the sum of the effective widths for each side of the *beam centerline*, each of which shall not exceed:

- (1) one-eighth of the beam span, center-to-center of supports;
- (2) one-half the distance to the centerline of the adjacent beam; or
- (3) the distance to the edge of the slab.

1b. Strength During Construction

When temporary shores are not used during construction, the steel section alone shall have adequate strength to support all *loads* applied prior to the concrete attaining 75% of its specified strength f'_c . The *available flexural strength* of the steel section shall be determined in accordance with Chapter F.

2. Composite Beams With Steel Headed Stud or Steel Channel Anchors

2a. Positive Flexural Strength

The *design positive flexural strength*, $\phi_b M_n$, and *allowable positive flexural strength*, M_n/Ω_b , shall be determined for the *limit state of yielding* as follows:

$$\phi_b = 0.90 \text{ (LRFD)} \quad \Omega_b = 1.67 \text{ (ASD)}$$

- (a) When $h/t_w \leq 3.76\sqrt{E/F_y}$

M_n shall be determined from the plastic *stress* distribution on the composite section for the limit state of *yielding (plastic moment)*.

User Note: All current ASTM A6 W, S and HP shapes satisfy the limit given in Section I3.2a(a) for $F_y \leq 50$ ksi (345 MPa).

- (b) When $h/t_w > 3.76\sqrt{E/F_y}$

M_n shall be determined from the superposition of elastic stresses, considering the effects of shoring, for the limit state of *yielding (yield moment)*.

2b. Negative Flexural Strength

The *available negative flexural strength* shall be determined for the steel section alone, in accordance with the requirements of Chapter F.

Alternatively, the available negative flexural strength shall be determined from the plastic stress distribution on the composite section, for the *limit state of yielding (plastic moment)*, with

$$\phi_b = 0.90 \text{ (LRFD)} \quad \Omega_b = 1.67 \text{ (ASD)}$$

provided that the following limitations are met:

- (1) The steel *beam* is *compact* and is adequately braced in accordance with Chapter F.
- (2) Steel headed stud or steel channel anchors connect the slab to the steel beam in the negative moment region.
- (3) The slab reinforcement parallel to the steel beam, within the *effective width* of the slab, is *properly developed*.

2c. Composite Beams With Formed Steel Deck

(1) General

The available flexural strength of composite construction consisting of concrete slabs on *formed steel deck* connected to steel *beams* shall be determined by the applicable portions of Sections I3.2a and I3.2b, with the following requirements:

- (1) The *nominal rib height* shall not be greater than 3 in. (75 mm). The average width of concrete rib or haunch, w_r , shall be not less than 2 in. (50 mm), but shall not be taken in calculations as more than the minimum clear width near the top of the steel deck.
- (2) The concrete slab shall be connected to the steel beam with welded steel headed stud anchors, $\frac{3}{4}$ in. (19 mm) or less in diameter (AWS D1.1/D1.1M). Steel headed stud anchors shall be welded either through the deck or directly to the steel cross section. Steel headed stud anchors, after installation, shall extend not less than $1\frac{1}{2}$ in. (38 mm) above the top of the steel deck and there shall be at least $\frac{1}{2}$ in. (13 mm) of specified concrete cover above the top of the steel headed stud anchors.
- (3) The slab thickness above the steel deck shall be not less than 2 in. (50 mm).
- (4) Steel deck shall be anchored to all supporting members at a spacing not to exceed 18 in. (460 mm). Such anchorage shall be provided by steel headed stud anchors, a combination of steel headed stud anchors and arc spot (puddle) welds, or other devices specified by the contract documents.

(2) Deck Ribs Oriented Perpendicular to Steel Beam

Concrete below the top of the steel deck shall be neglected in determining composite section properties and in calculating A_c for deck ribs oriented perpendicular to the steel beams.

(3) Deck Ribs Oriented Parallel to Steel Beam

Concrete below the top of the steel deck is permitted to be included in determining composite section properties and shall be included in calculating A_c .

Formed steel deck ribs over supporting beams are permitted to be split longitudinally and separated to form a *concrete haunch*.

When the nominal depth of steel deck is $1\frac{1}{2}$ in. (38 mm) or greater, the average width, w_r , of the supported haunch or rib shall be not less than 2 in. (50 mm) for the first steel headed stud anchor in the transverse row plus four stud diameters for each additional steel headed stud anchor.

2d. Load Transfer Between Steel Beam and Concrete Slab

(1) Load Transfer for Positive Flexural Strength

The entire *horizontal shear* at the interface between the steel *beam* and the concrete slab shall be assumed to be transferred by steel headed stud or steel channel anchors, except for *concrete-encased beams* as defined in Section I3.3. For composite action with concrete subject to flexural compression, the nominal shear force between the steel beam and the concrete slab transferred by *steel anchors*, V' , between the point of maximum positive moment and the point of zero moment shall be determined as the lowest value in accordance with the *limit*

states of concrete crushing, tensile yielding of the steel section, or the shear strength of the steel anchors:

- (a) Concrete crushing

$$V' = 0.85f'_c A_c \quad (I3-1a)$$

- (b) Tensile yielding of the steel section

$$V' = F_y A_s \quad (I3-1b)$$

- (c) Shear strength of steel headed stud or steel channel anchors

$$V' = \Sigma Q_n \quad (I3-1c)$$

where

A_c = area of concrete slab within *effective width*, in.² (mm²)

A_s = area of steel cross section, in.² (mm²)

ΣQ_n = sum of *nominal shear strengths* of steel headed stud or steel channel anchors between the point of maximum positive moment and the point of zero moment, kips (N)

(2) Load Transfer for Negative Flexural Strength

In continuous composite beams where longitudinal reinforcing steel in the negative moment regions is considered to act compositely with the steel beam, the total horizontal shear between the point of maximum negative moment and the point of zero moment shall be determined as the lower value in accordance with the following limit states:

- (a) For the limit state of tensile yielding of the slab reinforcement

$$V' = F_{ysr} A_{sr} \quad (I3-2a)$$

where

A_{sr} = area of adequately developed longitudinal reinforcing steel within the effective width of the concrete slab, in.² (mm²)

F_{ysr} = *specified minimum yield stress* of the reinforcing steel, ksi (MPa)

- (b) For the limit state of shear strength of steel headed stud or steel channel anchors

$$V' = \Sigma Q_n \quad (I3-2b)$$

3. Encased Composite Members

The *available flexural strength* of concrete-encased members shall be determined as follows:

$$\phi_b = 0.90 \text{ (LRFD)} \quad \Omega_b = 1.67 \text{ (ASD)}$$

The nominal flexural strength, M_n , shall be determined using one of the following methods:

- (a) The superposition of elastic *stresses* on the composite section, considering the effects of shoring for the *limit state* of yielding (*yield moment*).

- (b) The plastic stress distribution on the steel section alone, for the limit state of yielding (*plastic moment*) on the steel section.
- (c) The plastic stress distribution on the composite section or the strain-compatibility method, for the limit state of yielding (*plastic moment*) on the composite section. For concrete-encased members, *steel anchors* shall be provided.

4. Filled Composite Members

4a. Limitations

Filled composite sections shall be classified for *local buckling* according to Section I1.4.

4b. Flexural Strength

The *available flexural strength* of *filled composite members* shall be determined as follows:

$$\phi_b = 0.90 \text{ (LRFD)} \quad \Omega_b = 1.67 \text{ (ASD)}$$

The nominal flexural strength, M_n , shall be determined as follows:

- (a) For *compact sections*

$$M_n = M_p \tag{I3-3a}$$

where

M_p = moment corresponding to plastic *stress* distribution over the composite cross section, kip-in. (N-mm)

- (b) For *noncompact sections*

$$M_n = M_p - (M_p - M_y) \left(\frac{\lambda - \lambda_p}{\lambda_r - \lambda_p} \right) \tag{I3-3b}$$

where

λ , λ_p and λ_r are slenderness ratios determined from Table I1.1b.

M_y = *yield moment* corresponding to yielding of the tension flange and first yield of the compression flange, kip-in. (N-mm). The capacity at first yield shall be calculated assuming a linear elastic stress distribution with the maximum concrete compressive stress limited to $0.7f'_c$ and the maximum steel stress limited to F_y .

- (c) For slender sections, M_n , shall be determined as the first yield moment. The compression flange stress shall be limited to the *local buckling* stress, F_{cr} , determined using Equation I2-10 or I2-11. The concrete stress distribution shall be linear elastic with the maximum compressive stress limited to $0.70f'_c$.

I4. SHEAR

1. Filled and Encased Composite Members

The *design shear strength*, $\phi_v V_n$, and *allowable shear strength*, V_n/Ω_v , shall be determined based on one of the following:

- (a) The *available shear strength* of the steel section alone as specified in Chapter G
- (b) The available shear strength of the reinforced concrete portion (concrete plus steel reinforcement) alone as defined by ACI 318 with

$$\phi_v = 0.75 \text{ (LRFD)} \quad \Omega_v = 2.00 \text{ (ASD)}$$

- (c) The *nominal shear strength* of the steel section as defined in Chapter G plus the nominal strength of the reinforcing steel as defined by ACI 318 with a combined resistance or *safety factor* of

$$\phi_v = 0.75 \text{ (LRFD)} \quad \Omega_v = 2.00 \text{ (ASD)}$$

2. Composite Beams With Formed Steel Deck

The available shear strength of *composite beams* with steel headed stud or steel channel anchors shall be determined based upon the properties of the steel section alone in accordance with Chapter G.

I5. COMBINED FLEXURE AND AXIAL FORCE

The interaction between flexure and axial forces in composite members shall account for *stability* as required by Chapter C. The *available compressive strength* and the *available flexural strength* shall be determined as defined in Sections I2 and I3, respectively. To account for the influence of *length effects* on the axial strength of the member, the nominal axial strength of the member shall be determined in accordance with Section I2.

For *encased composite members* and for *filled composite members* with *compact sections*, the interaction between axial force and flexure shall be based on the interaction equations of Section H1.1 or one of the methods as defined in Section I1.2.

For filled composite members with noncompact or slender sections, the interaction between axial forces and flexure shall be based on the interaction equations of Section H1.1.

User Note: Methods for determining the capacity of composite *beam-columns* are discussed in the Commentary.

I6. LOAD TRANSFER

1. General Requirements

When external forces are applied to an axially loaded encased or *filled composite member*, the introduction of force to the member and the transfer of longitudinal

shears within the member shall be assessed in accordance with the requirements for force allocation presented in this section.

The *design strength*, ϕR_n , or the *allowable strength*, R_n/Ω , of the applicable force transfer mechanisms as determined in accordance with Section I6.3 shall equal or exceed the required longitudinal shear force to be transferred, V_r' , as determined in accordance with Section I6.2.

2. Force Allocation

Force allocation shall be determined based upon the distribution of external force in accordance with the following requirements:

User Note: *Bearing* strength provisions for externally applied forces are provided in Section J8. For *filled composite members*, the term $\sqrt{A_2/A_1}$ in Equation J8-2 may be taken equal to 2.0 due to confinement effects.

2a. External Force Applied to Steel Section

When the entire external *force* is applied directly to the steel section, the force required to be transferred to the concrete, V_r' , shall be determined as follows:

$$V_r' = P_r (1 - F_y A_s / P_{no}) \quad (I6-1)$$

where

P_{no} = nominal axial compressive strength without consideration of *length effects*, determined by Equation I2-4 for *encased composite members*, and Equation I2-9a for *filled composite members*, kips (N)

P_r = required external force applied to the composite member, kips (N)

2b. External Force Applied to Concrete

When the entire external force is applied directly to the concrete encasement or concrete fill, the force required to be transferred to the steel, V_r' , shall be determined as follows:

$$V_r' = P_r (F_y A_s / P_{no}) \quad (I6-2)$$

where

P_{no} = nominal axial compressive strength without consideration of *length effects*, determined by Equation I2-4 for *encased composite members*, and Equation I2-9a for *filled composite members*, kips (N)

P_r = required external force applied to the composite member, kips (N)

2c. External Force Applied Concurrently to Steel and Concrete

When the external force is applied concurrently to the steel section and concrete encasement or concrete fill, V_r' shall be determined as the force required to establish equilibrium of the cross section.

User Note: The Commentary provides an acceptable method of determining the longitudinal shear force required for equilibrium of the cross section.

3. Force Transfer Mechanisms

The *nominal strength*, R_n , of the force transfer mechanisms of *direct bond interaction*, shear connection, and direct *bearing* shall be determined in accordance with this section. Use of the force transfer *mechanism* providing the largest nominal strength is permitted. Force transfer mechanisms shall not be superimposed.

The force transfer mechanism of direct bond interaction shall not be used for *encased composite members*.

3a. Direct Bearing

Where force is transferred in an encased or *filled composite member* by direct *bearing* from internal bearing mechanisms, the *available bearing strength* of the concrete for the *limit state of concrete crushing* shall be determined as follows:

$$R_n = 1.7f'_c A_1 \quad (I6-3)$$

$$\phi_B = 0.65 \text{ (LRFD)} \quad \Omega_B = 2.31 \text{ (ASD)}$$

where

A_1 = loaded area of concrete, in.² (mm²)

User Note: An example of force transfer via an internal bearing mechanism is the use of internal steel plates within a filled composite member.

3b. Shear Connection

Where force is transferred in an encased or *filled composite member* by shear connection, the *available shear strength* of steel headed stud or steel channel anchors shall be determined as follows:

$$R_c = \Sigma Q_{cv} \quad (I6-4)$$

where

ΣQ_{cv} = sum of *available shear strengths*, ϕQ_m or Q_m/Ω as appropriate, of steel headed stud or steel channel anchors, determined in accordance with Section I8.3a or Section I8.3d, respectively, placed within the *load introduction length* as defined in Section I6.4, kips (N)

3c. Direct Bond Interaction

Where force is transferred in a *filled composite member* by *direct bond interaction*, the *available bond strength* between the steel and concrete shall be determined as follows:

$$\phi = 0.45 \text{ (LRFD)} \quad \Omega = 3.33 \text{ (ASD)}$$

(a) For rectangular steel sections filled with concrete:

$$R_n = B^2 C_{in} F_{in} \quad (16-5)$$

(b) For round steel sections filled with concrete:

$$R_n = 0.25\pi D^2 C_{in} F_{in} \quad (16-6)$$

where

$C_{in} = 2$ if the filled composite member extends to one side of the point of force transfer

$= 4$ if the filled composite member extends on both sides of the point of force transfer

R_n = nominal bond strength, kips (N)

F_{in} = nominal bond *stress* = 0.06 ksi (0.40 MPa)

B = overall width of rectangular steel section along face transferring *load*, in. (mm)

D = outside diameter of round *HSS*, in. (mm)

4. Detailing Requirements

4a. Encased Composite Members

Steel anchors utilized to transfer longitudinal shear shall be distributed within the *load introduction length*, which shall not exceed a distance of two times the minimum transverse dimension of the *encased composite member* above and below the *load transfer region*. Anchors utilized to transfer longitudinal shear shall be placed on at least two faces of the steel shape in a generally symmetric configuration about the steel shape axes.

Steel anchor spacing, both within and outside of the load introduction length, shall conform to Section I8.3e.

4b. Filled Composite Members

Where required, steel anchors transferring the required longitudinal shear force shall be distributed within the *load introduction length*, which shall not exceed a distance of two times the minimum transverse dimension of a rectangular steel member or two times the diameter of a round steel member both above and below the *load transfer region*. Steel anchor spacing within the load introduction length shall conform to Section I8.3e.

17. COMPOSITE DIAPHRAGMS AND COLLECTOR BEAMS

Composite slab diaphragms and *collector beams* shall be designed and detailed to transfer *loads* between the diaphragm, the diaphragm's boundary members and collector elements, and elements of the lateral force resisting system.

User Note: Design guidelines for composite diaphragms and collector beams can be found in the Commentary.

18. STEEL ANCHORS

1. General

The diameter of a steel headed stud anchor shall not be greater than 2.5 times the thickness of the base metal to which it is welded, unless it is welded to a flange directly over a web.

Section I8.2 applies to a *composite* flexural member where *steel anchors* are embedded in a solid concrete slab or in a slab cast on *formed steel* deck. Section I8.3 applies to all other cases.

2. Steel Anchors in Composite Beams

The length of steel headed stud anchors shall not be less than four stud diameters from the base of the steel headed stud anchor to the top of the stud head after installation.

2a. Strength of Steel Headed Stud Anchors

The *nominal shear strength* of one steel headed stud anchor embedded in a solid concrete slab or in a composite slab with decking shall be determined as follows:

$$Q_n = 0.5A_{sa}\sqrt{f'_c E_c} \leq R_g R_p A_{sa} F_u \quad (I8-1)$$

where

A_{sa} = cross-sectional area of steel headed stud anchor, in.² (mm²)

E_c = modulus of elasticity of concrete

= $w_c^{1.5}\sqrt{f'_c}$, ksi (0.043 $w_c^{1.5}\sqrt{f'_c}$, MPa)

F_u = *specified minimum tensile strength* of a steel headed stud anchor, ksi (MPa)

R_g = 1.0 for:

- (a) one steel headed stud anchor welded in a steel deck rib with the deck oriented perpendicular to the steel shape;
- (b) any number of steel headed stud anchors welded in a row directly to the steel shape;
- (c) any number of steel headed stud anchors welded in a row through steel deck with the deck oriented parallel to the steel shape and the ratio of the *average rib width* to rib depth ≥ 1.5

= 0.85 for:

- (a) two steel headed stud anchors welded in a steel deck rib with the deck oriented perpendicular to the steel shape;
- (b) one steel headed stud anchor welded through steel deck with the deck oriented parallel to the steel shape and the ratio of the average rib width to rib depth < 1.5

= 0.7 for three or more steel headed stud anchors welded in a steel deck rib with the deck oriented perpendicular to the steel shape

$R_p = 0.75$ for:

- (a) steel headed stud anchors welded directly to the steel shape;
- (b) steel headed stud anchors welded in a composite slab with the deck oriented perpendicular to the *beam* and $e_{mid-ht} \geq 2$ in. (50 mm);
- (c) steel headed stud anchors welded through steel deck, or steel sheet used as *girder filler* material, and embedded in a composite slab with the deck oriented parallel to the beam

$= 0.6$ for steel headed stud anchors welded in a composite slab with deck oriented perpendicular to the beam and $e_{mid-ht} < 2$ in. (50 mm)

e_{mid-ht} = distance from the edge of steel headed stud anchor shank to the steel deck web, measured at mid-height of the deck rib, and in the *load bearing* direction of the steel headed stud anchor (in other words, in the direction of maximum moment for a simply supported beam), in. (mm)

User Note: The table below presents values for R_g and R_p for several cases. Capacities for steel headed stud anchors can be found in the Manual.

Condition	R_g	R_p
No decking	1.0	0.75
Decking oriented parallel to the steel shape		
$\frac{w_r}{h_r} \geq 1.5$	1.0	0.75
$\frac{w_r}{h_r} < 1.5$	0.85**	0.75
Decking oriented perpendicular to the steel shape		
Number of steel headed stud anchors occupying the same decking rib		
1	1.0	0.6 ⁺
2	0.85	0.6 ⁺
3 or more	0.7	0.6 ⁺

h_r = nominal rib height, in. (mm)

w_r = average width of concrete rib or haunch (as defined in Section I3.2c), in. (mm)

** for a single steel headed stud anchor

⁺ this value may be increased to 0.75 when $e_{mid-ht} \geq 2$ in. (51 mm)

2b. Strength of Steel Channel Anchors

The nominal shear strength of one hot-rolled channel anchor embedded in a solid concrete slab shall be determined as follows:

$$Q_n = 0.3(t_f + 0.5t_w)l_a\sqrt{f'_cE_c} \quad (18-2)$$

where

l_a = length of channel anchor, in. (mm)

t_f = thickness of flange of channel anchor, in. (mm)

t_w = thickness of channel anchor web, in. (mm)

The strength of the channel anchor shall be developed by welding the channel to the *beam* flange for a force equal to Q_n , considering eccentricity on the anchor.

2c. Required Number of Steel Anchors

The number of anchors required between the section of maximum bending moment, positive or negative, and the adjacent section of zero moment shall be equal to the *horizontal shear* as determined in Sections I3.2d(1) and I3.2d(2) divided by the nominal shear strength of one *steel anchor* as determined from Section 18.2a or Section 18.2b. The number of steel anchors required between any concentrated *load* and the nearest point of zero moment shall be sufficient to develop the maximum moment required at the concentrated load point.

2d. Detailing Requirements

Steel anchors required on each side of the point of maximum bending moment, positive or negative, shall be distributed uniformly between that point and the adjacent points of zero moment, unless specified otherwise on the contract documents.

Steel anchors shall have at least 1 in. (25 mm) of lateral concrete cover in the direction perpendicular to the shear force, except for anchors installed in the ribs of formed steel decks. The minimum distance from the center of an anchor to a free edge in the direction of the shear force shall be 8 in. (203 mm) if normal weight concrete is used and 10 in. (250 mm) if *lightweight concrete* is used. The provisions of ACI 318, Appendix D are permitted to be used in lieu of these values.

The minimum center-to-center spacing of steel headed stud anchors shall be six diameters along the longitudinal axis of the supporting composite *beam* and four diameters transverse to the longitudinal axis of the supporting composite beam, except that within the ribs of formed steel decks oriented perpendicular to the steel beam the minimum center-to-center spacing shall be four diameters in any direction. The maximum center-to-center spacing of steel anchors shall not exceed eight times the total slab thickness or 36 in. (900 mm).

3. Steel Anchors in Composite Components

This section shall apply to the design of cast-in-place steel headed stud anchors and steel channel anchors in *composite components*.

The provisions of the *applicable building code* or ACI 318, Appendix D may be used in lieu of the provisions in this section.

User Note: The steel headed stud anchor strength provisions in this section are applicable to anchors located primarily in the *load transfer* (connection) region of composite *columns* and *beam-columns*, concrete-encased and filled composite beams, composite coupling *beams*, and composite walls, where the steel and concrete are working compositely within a member. They are not intended for hybrid construction where the steel and concrete are not working compositely, such as with embed plates.

Section I8.2 specifies the strength of *steel anchors* embedded in a solid concrete slab or in a concrete slab with formed steel deck in a composite beam.

Limit states for the steel shank of the anchor and for concrete breakout in shear are covered directly in this Section. Additionally, the spacing and dimensional limitations provided in these provisions preclude the limit states of concrete pry-out for anchors loaded in shear and concrete breakout for anchors loaded in tension as defined by ACI 318, Appendix D.

For normal weight concrete: Steel headed stud anchors subjected to shear only shall not be less than five stud diameters in length from the base of the steel headed stud to the top of the stud head after installation. Steel headed stud anchors subjected to tension or interaction of shear and tension shall not be less than eight stud diameters in length from the base of the stud to the top of the stud head after installation.

For *lightweight concrete*: Steel headed stud anchors subjected to shear only shall not be less than seven stud diameters in length from the base of the steel headed stud to the top of the stud head after installation. Steel headed stud anchors subjected to tension shall not be less than ten stud diameters in length from the base of the stud to the top of the stud head after installation. The *nominal strength* of steel headed stud anchors subjected to interaction of shear and tension for lightweight concrete shall be determined as stipulated by the applicable building code or ACI 318 Appendix D.

Steel headed stud anchors subjected to tension or interaction of shear and tension shall have a diameter of the head greater than or equal to 1.6 times the diameter of the shank.

User Note: The following table presents values of minimum steel headed stud anchor h/d ratios for each condition covered in the Specification:

Loading Condition	Normal Weight Concrete	Lightweight Concrete
Shear	$h/d \geq 5$	$h/d \geq 7$
Tension	$h/d \geq 8$	$h/d \geq 10$
Shear and Tension	$h/d \geq 8$	N/A*

h/d = ratio of steel headed stud anchor shank length to the top of the stud head, to shank diameter

* Refer to ACI 318, Appendix D for the calculation of interaction effects of anchors embedded in lightweight concrete.

3a. Shear Strength of Steel Headed Stud Anchors in Composite Components

Where concrete breakout strength in shear is not an applicable *limit state*, the *design shear strength*, $\phi_v Q_m$, and *allowable shear strength*, Q_m/Ω_v , of one steel headed stud anchor shall be determined as follows:

$$Q_m = F_u A_{sa} \quad (I8-3)$$

$$\phi_v = 0.65 \text{ (LRFD)} \quad \Omega_v = 2.31 \text{ (ASD)}$$

where

Q_m = nominal shear strength of steel headed stud anchor, kips (N)

A_{sa} = cross-sectional area of steel headed stud anchor, in.² (mm²)

F_u = *specified minimum tensile strength* of a steel headed stud anchor, ksi (MPa)

Where concrete breakout strength in shear is an applicable *limit state*, the *available shear strength* of one steel headed stud anchor shall be determined by one of the following:

- (1) Where anchor reinforcement is developed in accordance with Chapter 12 of ACI 318 on both sides of the *concrete breakout surface* for the steel headed stud anchor, the minimum of the steel nominal shear strength from Equation I8-3 and the *nominal strength* of the anchor reinforcement shall be used for the nominal shear strength, Q_m , of the steel headed stud anchor.
- (2) As stipulated by the *applicable building code* or ACI 318, Appendix D.

User Note: If concrete breakout strength in shear is an applicable limit state (for example, where the breakout prism is not restrained by an adjacent steel plate, flange or web), appropriate anchor reinforcement is required for the provisions of this Section to be used. Alternatively, the provisions of the applicable building code or ACI 318, Appendix D may be used.

3b. Tensile Strength of Steel Headed Stud Anchors in Composite Components

Where the distance from the center of an anchor to a free edge of concrete in the direction perpendicular to the height of the steel headed stud anchor is greater than or equal to 1.5 times the height of the steel headed stud anchor measured to the top of the stud head, and where the center-to-center spacing of steel headed stud anchors is greater than or equal to three times the height of the steel headed stud anchor measured to the top of the stud head, the *available tensile strength* of one steel headed stud anchor shall be determined as follows:

$$Q_{nt} = F_u A_{sa} \quad (18-4)$$

$$\phi_t = 0.75 \text{ (LRFD)} \quad \Omega_t = 2.00 \text{ (ASD)}$$

where

Q_{nt} = nominal tensile strength of steel headed stud anchor, kips (N)

Where the distance from the center of an anchor to a free edge of concrete in the direction perpendicular to the height of the steel headed stud anchor is less than 1.5 times the height of the steel headed stud anchor measured to the top of the stud head, or where the center-to-center spacing of steel headed stud anchors is less than three times the height of the steel headed stud anchor measured to the top of the stud head, the nominal tensile strength of one steel headed stud anchor shall be determined by one of the following:

- (a) Where anchor reinforcement is developed in accordance with Chapter 12 of ACI 318 on both sides of the *concrete breakout surface* for the steel headed stud anchor, the minimum of the steel nominal tensile strength from Equation I8-4 and the *nominal strength* of the anchor reinforcement shall be used for the nominal tensile strength, Q_{nt} , of the steel headed stud anchor.
- (b) As stipulated by the *applicable building code* or ACI 318, Appendix D.

User Note: Supplemental confining reinforcement is recommended around the anchors for steel headed stud anchors subjected to tension or interaction of shear and tension to avoid edge effects or effects from closely spaced anchors. See the Commentary and ACI 318, Section D5.2.9 for guidelines.

3c. Strength of Steel Headed Stud Anchors for Interaction of Shear and Tension in Composite Components

Where concrete breakout strength in shear is not a governing *limit state*, and where the distance from the center of an anchor to a free edge of concrete in the direction

perpendicular to the height of the steel headed stud anchor is greater than or equal to 1.5 times the height of the steel headed stud anchor measured to the top of the stud head, and where the center-to-center spacing of steel headed stud anchors is greater than or equal to three times the height of the steel headed stud anchor measured to the top of the stud head, the *nominal strength* for interaction of shear and tension of one steel headed stud anchor shall be determined as follows:

$$\left[\left(\frac{Q_{rt}}{Q_{ct}} \right)^{5/3} + \left(\frac{Q_{rv}}{Q_{cv}} \right)^{5/3} \right] \leq 1.0 \quad (18-5)$$

where

Q_{ct} = available tensile strength, kips (N)

Q_{rt} = required tensile strength, kips (N)

Q_{cv} = available shear strength, kips (N)

Q_{rv} = required shear strength, kips (N)

For design in accordance with Section B3.3 (LRFD):

Q_{rt} = required tensile strength using *LRFD load combinations*, kips (N)

$Q_{ct} = \phi_t Q_{nt}$ = design tensile strength, determined in accordance with Section 18.3b, kips (N)

Q_{rv} = required shear strength using LRFD load combinations, kips (N)

$Q_{cv} = \phi_v Q_{nv}$ = design shear strength, determined in accordance with Section 18.3a, kips (N)

ϕ_t = resistance factor for tension = 0.75

ϕ_v = resistance factor for shear = 0.65

For design in accordance with Section B3.4 (ASD):

Q_{rt} = required tensile strength using *ASD load combinations*, kips (N)

$Q_{ct} = \frac{Q_{nt}}{\Omega_t}$ = allowable tensile strength, determined in accordance with Section 18.3b, kips (N)

Q_{rv} = required shear strength using ASD load combinations, kips (N)

$Q_{cv} = \frac{Q_{nv}}{\Omega_v}$ = allowable shear strength, determined in accordance with Section 18.3a, kips (N)

Ω_t = safety factor for tension = 2.00

Ω_v = safety factor for shear = 2.31

Where concrete breakout strength in shear is a governing limit state, or where the distance from the center of an anchor to a free edge of concrete in the direction perpendicular to the height of the steel headed stud anchor is less than 1.5 times the height of the steel headed stud anchor measured to the top of the stud head, or where the center-to-center spacing of steel headed stud anchors is less than three times the height of the steel headed stud anchor measured to the top of the stud head, the nominal strength for interaction of shear and tension of one steel headed stud anchor shall be determined by one of the following:

- (a) Where anchor reinforcement is developed in accordance with Chapter 12 of ACI 318 on both sides of the *concrete breakout surface* for the steel headed stud

anchor, the minimum of the steel nominal shear strength from Equation I8-3 and the nominal strength of the anchor reinforcement shall be used for the nominal shear strength, Q_{nv} , of the steel headed stud anchor, and the minimum of the steel nominal tensile strength from Equation I8-4 and the nominal strength of the anchor reinforcement shall be used for the nominal tensile strength, Q_{nt} , of the steel headed stud anchor for use in Equation I8-5.

(b) As stipulated by the *applicable building code* or ACI 318, Appendix D.

3d. Shear Strength of Steel Channel Anchors in Composite Components

The available shear strength of steel channel anchors shall be based on the provisions of Section I8.2b with the resistance factor and safety factor as specified below.

$$\phi_v = 0.75 \text{ (LRFD)} \quad \Omega_v = 2.00 \text{ (ASD)}$$

3e. Detailing Requirements in Composite Components

Steel anchors shall have at least 1 in. (25 mm) of lateral clear concrete cover. The minimum center-to-center spacing of steel headed stud anchors shall be four diameters in any direction. The maximum center-to-center spacing of steel headed stud anchors shall not exceed 32 times the shank diameter. The maximum center-to-center spacing of steel channel anchors shall be 24 in. (600 mm).

User Note: Detailing requirements provided in this section are absolute limits. See Sections I8.3a, I8.3b and I8.3c for additional limitations required to preclude edge and group effect considerations.

19. SPECIAL CASES

When *composite* construction does not conform to the requirements of Section I1 through Section I8, the strength of *steel anchors* and details of construction shall be established by testing.

CHAPTER J

DESIGN OF CONNECTIONS

This chapter addresses connecting elements, connectors and the affected elements of connected members not subject to *fatigue loads*.

The chapter is organized as follows:

- J1. General Provisions
- J2. Welds
- J3. Bolts and Threaded Parts
- J4. Affected Elements of Members and Connecting Elements
- J5. Fillers
- J6. Splices
- J7. Bearing Strength
- J8. Column Bases and Bearing on Concrete
- J9. Anchor Rods and Embedments
- J10. Flanges and Webs with Concentrated Forces

User Note: For cases not included in this chapter, the following sections apply:

- Chapter K Design of HSS and Box Member Connections
- Appendix 3 Design for Fatigue

J1. GENERAL PROVISIONS

1. Design Basis

The *design strength*, ϕR_n , and the *allowable strength* R_n/Ω , of *connections* shall be determined in accordance with the provisions of this chapter and the provisions of Chapter B.

The *required strength* of the connections shall be determined by *structural analysis* for the specified *design loads*, consistent with the type of construction specified, or shall be a proportion of the required strength of the connected members when so specified herein.

Where the gravity axes of intersecting axially loaded members do not intersect at one point, the effects of eccentricity shall be considered.

2. Simple Connections

Simple connections of *beams*, girders and trusses shall be designed as flexible and are permitted to be proportioned for the reaction shears only, except as otherwise indicated in the design documents. Flexible beam connections shall accommodate end rotations of simple beams. Some inelastic but self-limiting deformation in the connection is permitted to accommodate the end rotation of a simple beam.

3. Moment Connections

End connections of restrained *beams*, girders and trusses shall be designed for the combined effect of forces resulting from moment and shear induced by the rigidity of the connections. Response criteria for moment connections are provided in Section B3.6b.

User Note: See Chapter C and Appendix 7 for analysis requirements to establish the *required strength* for the design of connections.

4. Compression Members With Bearing Joints

Compression members relying on *bearing for load* transfer shall meet the following requirements:

- (1) When *columns* bear on bearing plates or are finished to bear at *splices*, there shall be sufficient connectors to hold all parts securely in place.
- (2) When compression members other than columns are finished to bear, the splice material and its connectors shall be arranged to hold all parts in line and their required strength shall be the lesser of:
 - (i) An axial tensile force of 50% of the required compressive strength of the member; or
 - (ii) The moment and shear resulting from a transverse load equal to 2% of the required compressive strength of the member. The transverse load shall be applied at the location of the splice exclusive of other loads that act on the member. The member shall be taken as pinned for the determination of the shears and moments at the splice.

User Note: All compression *joints* should also be proportioned to resist any tension developed by the *load combinations* stipulated in Section B2.

5. Splices in Heavy Sections

When tensile forces due to applied tension or flexure are to be transmitted through *splices* in heavy sections, as defined in Sections A3.1c and A3.1d, by complete-joint-penetration groove (CJP) welds, the following provisions apply: (1) material notch-toughness requirements as given in Sections A3.1c and A3.1d; (2) weld access hole details as given in Section J1.6; (3) *filler metal* requirements as given in Section J2.6; and (4) thermal cut surface preparation and inspection requirements as given in Section M2.2. The foregoing provision is not applicable to splices of elements of *built-up shapes* that are welded prior to assembling the shape.

User Note: CJP groove welded splices of heavy sections can exhibit detrimental effects of weld shrinkage. Members that are sized for compression that are also subject to tensile forces may be less susceptible to damage from shrinkage if they are spliced using partial-joint-penetration PJP groove welds on the flanges and fillet-welded web plates, or using bolts for some or all of the splice.

6. Weld Access Holes

All weld access holes required to facilitate welding operations shall be detailed to provide room for weld backing as needed. The access hole shall have a length from the toe of the weld preparation not less than $1\frac{1}{2}$ times the thickness of the material in which the hole is made, nor less than $1\frac{1}{2}$ in. (38 mm). The access hole shall have a height not less than the thickness of the material with the access hole, nor less than $\frac{3}{4}$ in. (19 mm), nor does it need to exceed 2 in. (50 mm).

For sections that are rolled or welded prior to cutting, the edge of the web shall be sloped or curved from the surface of the flange to the *reentrant* surface of the access hole. In hot-rolled shapes, and *built-up shapes* with CJP *groove welds* that join the web-to-flange, weld access holes shall be free of notches and sharp reentrant corners. No arc of the weld access hole shall have a radius less than $\frac{3}{8}$ in. (10 mm).

In built-up shapes with fillet or *partial-joint-penetration groove welds* that join the web-to-flange, weld access holes shall be free of notches and sharp reentrant corners. The access hole shall be permitted to terminate perpendicular to the flange, providing the weld is terminated at least a distance equal to the weld size away from the access hole.

For heavy sections as defined in Sections A3.1c and A3.1d, the *thermally cut* surfaces of weld access holes shall be ground to bright metal and inspected by either magnetic particle or dye penetrant methods prior to deposition of *splice* welds. If the curved transition portion of weld access holes is formed by predrilled or sawed holes, that portion of the access hole need not be ground. Weld access holes in other shapes need not be ground nor inspected by dye penetrant or magnetic particle methods.

7. Placement of Welds and Bolts

Groups of welds or bolts at the ends of any member which transmit axial force into that member shall be sized so that the center of gravity of the group coincides with the center of gravity of the member, unless provision is made for the eccentricity. The foregoing provision is not applicable to end connections of single angle, double angle and similar members.

8. Bolts in Combination With Welds

Bolts shall not be considered as sharing the *load* in combination with welds, except that shear connections with any grade of bolts permitted by Section A3.3, installed in standard holes or short slots transverse to the direction of the load, are permitted to be considered to share the load with longitudinally loaded *fillet welds*. In such connections the *available strength* of the bolts shall not be taken as greater than 50% of the available strength of bearing-type bolts in the connection.

In making welded alterations to structures, existing rivets and high-strength bolts tightened to the requirements for *slip-critical connections* are permitted to be utilized for carrying loads present at the time of alteration and the welding need only provide the additional required strength.

9. High-Strength Bolts in Combination With Rivets

In both new work and alterations, in connections designed as *slip-critical connections* in accordance with the provisions of Section J3, high-strength bolts are permitted to be considered as sharing the *load* with existing rivets.

10. Limitations on Bolted and Welded Connections

Joints with *pretensioned bolts* or welds shall be used for the following connections:

- (1) *Column splices* in all multi-story structures over 125 ft (38 m) in height
- (2) Connections of all *beams* and *girders* to columns and any other beams and girders on which the *bracing* of columns is dependent in structures over 125 ft (38 m) in height
- (3) In all structures carrying cranes of over 5 ton (50 kN) capacity: roof truss splices and connections of trusses to columns; column splices; column bracing; knee braces; and crane supports
- (4) Connections for the support of machinery and other live *loads* that produce impact or reversal of load

Snug-tightened joints or joints with ASTM A307 bolts shall be permitted except where otherwise specified.

J2. WELDS

All provisions of AWS D1.1/D1.1M apply under this Specification, with the exception that the provisions of the listed AISC Specification Sections apply under this Specification in lieu of the cited AWS provisions as follows:

- (1) Section J1.6 in lieu of AWS D1.1/D1.1M, Section 5.17.1
- (2) Section J2.2a in lieu of AWS D1.1/D1.1M, Section 2.4.2.10
- (3) Table J2.2 in lieu of AWS D1.1/D1.1M, Table 2.1
- (4) Table J2.5 in lieu of AWS D1.1/D1.1M, Table 2.3
- (5) Appendix 3, Table A-3.1 in lieu of AWS D1.1/D1.1M, Table 2.5
- (6) Section B3.11 and Appendix 3 in lieu of AWS D1.1/D1.1M, Section 2, Part C
- (7) Section M2.2 in lieu of AWS D1.1/D1.1M, Sections 5.15.4.3 and 5.15.4.4

1. Groove Welds

1a. Effective Area

The effective area of *groove welds* shall be considered as the length of the weld times the effective throat.

The effective throat of a *complete-joint-penetration (CJP) groove weld* shall be the thickness of the thinner part joined.

The effective throat of a *partial-joint-penetration (PJP) groove weld* shall be as shown in Table J2.1.

TABLE J2.1
Effective Throat of
Partial-Joint-Penetration Groove Welds

Welding Process	Welding Position F (flat), H (horizontal), V (vertical), OH (overhead)	Groove Type (AWS D1.1/D1.1M, Figure 3.3)	Effective Throat
Shielded metal arc (SMAW)	All	J or U groove	depth of groove
Gas metal arc (GMAW) Flux cored arc (FCAW)		60° V	
Submerged arc (SAW)	F	J or U groove 60° bevel or V	
Gas metal arc (GMAW) Flux cored arc (FCAW)	F, H	45° bevel	depth of groove
Shielded metal arc (SMAW)	All	45° bevel	depth of groove minus 1/8 in. (3 mm)
Gas metal arc (GMAW) Flux cored arc (FCAW)	V, OH		

User Note: The effective throat of a partial-joint-penetration groove weld is dependent on the process used and the weld position. The *design drawings* should either indicate the effective throat required or the weld strength required, and the fabricator should detail the *joint* based on the weld process and position to be used to weld the joint.

The effective weld throat for flare groove welds when filled flush to the surface of a round bar or a 90° bend in a *formed section* or rectangular *HSS*, shall be as shown in Table J2.2, unless other effective throats are demonstrated by tests. The effective throat of flare groove welds filled less than flush shall be as shown in Table J2.2, less the greatest perpendicular dimension measured from a line flush to the base metal surface to the weld surface.

Larger effective throats than those in Table J2.2 are permitted for a given welding procedure specification (WPS), provided the fabricator can establish by qualification the consistent production of such larger effective throat. Qualification shall consist of sectioning the weld normal to its axis, at mid-length and terminal ends. Such sectioning shall be made on a number of combinations of material sizes representative of the range to be used in the fabrication.

TABLE J2.2
Effective Weld Throats of Flare
Groove Welds

Welding Process	Flare Bevel Groove ^[a]	Flare V-Groove
GMAW and FCAW-G	$\frac{5}{8} R$	$\frac{3}{4} R$
SMAW and FCAW-S	$\frac{5}{16} R$	$\frac{5}{8} R$
SAW	$\frac{5}{16} R$	$\frac{1}{2} R$

^[a] For flare bevel groove with $R < 3/8$ in. (10 mm), use only reinforcing fillet weld on filled flush joint. General note: R = radius of joint surface (can be assumed to be $2t$ for HSS), in. (mm)

TABLE J2.3
Minimum Effective Throat of
Partial-Joint-Penetration Groove Welds

Material Thickness of Thinner Part Joined, in. (mm)	Minimum Effective Throat, ^[a] in. (mm)
To $\frac{1}{4}$ (6) inclusive	$\frac{1}{8}$ (3)
Over $\frac{1}{4}$ (6) to $\frac{1}{2}$ (13)	$\frac{3}{16}$ (5)
Over $\frac{1}{2}$ (13) to $\frac{3}{4}$ (19)	$\frac{1}{4}$ (6)
Over $\frac{3}{4}$ (19) to $1\frac{1}{2}$ (38)	$\frac{5}{16}$ (8)
Over $1\frac{1}{2}$ (38) to $2\frac{1}{4}$ (57)	$\frac{3}{8}$ (10)
Over $2\frac{1}{4}$ (57) to 6 (150)	$\frac{1}{2}$ (13)
Over 6 (150)	$\frac{5}{8}$ (16)

^[a] See Table J2.1.

1b. Limitations

The minimum effective throat of a *partial-joint-penetration groove weld* shall not be less than the size required to transmit calculated *forces* nor the size shown in Table J2.3. Minimum weld size is determined by the thinner of the two parts joined.

2. Fillet Welds

2a. Effective Area

The effective area of a *fillet weld* shall be the effective length multiplied by the effective throat. The effective throat of a fillet weld shall be the shortest distance from the root to the face of the diagrammatic weld. An increase in effective throat

TABLE J2.4
Minimum Size of Fillet Welds

Material Thickness of Thinner Part Joined, in. (mm)	Minimum Size of Fillet Weld, ^[a] in. (mm)
To 1/4 (6) inclusive	1/8 (3)
Over 1/4 (6) to 1/2 (13)	3/16 (5)
Over 1/2 (13) to 3/4 (19)	1/4 (6)
Over 3/4 (19)	5/16 (8)

^[a] Leg dimension of fillet welds. Single pass welds must be used.
Note: See Section J2.2b for maximum size of fillet welds.

is permitted if consistent penetration beyond the root of the diagrammatic weld is demonstrated by tests using the production process and procedure variables.

For fillet welds in holes and slots, the effective length shall be the length of the centerline of the weld along the center of the plane through the throat. In the case of overlapping fillets, the effective area shall not exceed the nominal cross-sectional area of the hole or slot, in the plane of the *faying surface*.

2b. Limitations

The minimum size of fillet welds shall be not less than the size required to transmit calculated forces, nor the size as shown in Table J2.4. These provisions do not apply to *fillet weld reinforcements of partial- or complete-joint-penetration groove welds*.

The maximum size of *fillet welds* of connected parts shall be:

- (a) Along edges of material less than 1/4-in. (6 mm) thick; not greater than the thickness of the material.
- (b) Along edges of material 1/4 in. (6 mm) or more in thickness; not greater than the thickness of the material minus 1/16 in. (2 mm), unless the weld is especially designated on the drawings to be built out to obtain full-throat thickness. In the as-welded condition, the distance between the edge of the base metal and the toe of the weld is permitted to be less than 1/16 in. (2 mm) provided the weld size is clearly verifiable.

The minimum length of fillet welds designed on the basis of strength shall be not less than four times the nominal weld size, or else the effective size of the weld shall be considered not to exceed one quarter of its length. If longitudinal fillet welds are used alone in end connections of flat-bar tension members, the length of each fillet weld shall be not less than the perpendicular distance between them. For the effect of longitudinal fillet weld length in end connections upon the effective area of the connected member, see Section D3.

For end-loaded fillet welds with a length up to 100 times the weld size, it is permitted to take the effective length equal to the actual length. When the length of the end-loaded fillet weld exceeds 100 times the weld size, the effective length shall be determined by multiplying the actual length by the reduction factor, β , determined as follows:

$$\beta = 1.2 - 0.002(l/w) \leq 1.0 \quad (\text{J2-1})$$

where

l = actual length of end-loaded weld, in. (mm)

w = size of weld leg, in. (mm)

When the length of the weld exceeds 300 times the leg size, w , the effective length shall be taken as $180w$.

Intermittent fillet welds are permitted to be used to transfer calculated *stress* across a *joint* or *faying surfaces* and to join components of *built-up members*. The length of any segment of intermittent fillet welding shall be not less than four times the weld size, with a minimum of $1\frac{1}{2}$ in. (38 mm).

In *lap joints*, the minimum amount of lap shall be five times the thickness of the thinner part joined, but not less than 1 in. (25 mm). Lap joints joining plates or bars subjected to axial stress that utilize transverse fillet welds only shall be fillet welded along the end of both lapped parts, except where the deflection of the lapped parts is sufficiently restrained to prevent opening of the joint under maximum loading.

Fillet weld terminations are permitted to be stopped short or extend to the ends or sides of parts or be boxed except as limited by the following:

- (1) For overlapping elements of members in which one connected part extends beyond an edge of another connected part that is subject to calculated tensile stress, fillet welds shall terminate not less than the size of the weld from that edge.
- (2) For *connections* where flexibility of the outstanding elements is required, when *end returns* are used the length of the return shall not exceed four times the nominal size of the weld nor half the width of the part.
- (3) Fillet welds joining *transverse stiffeners* to *plate girder webs* $\frac{3}{4}$ -in. (19 mm) thick or less shall end not less than four times nor more than six times the thickness of the web from the web toe of the web-to-flange welds, except where the ends of *stiffeners* are welded to the flange.
- (4) Fillet welds that occur on opposite sides of a common plane shall be interrupted at the corner common to both welds.

User Note: Fillet weld terminations should be located approximately one weld size from the edge of the connection to minimize notches in the base metal. Fillet welds terminated at the end of the joint, other than those connecting stiffeners to girder webs, are not a cause for correction.

Fillet welds in holes or slots are permitted to be used to transmit shear and resist loads perpendicular to the faying surface in lap joints or to prevent the *buckling* or

separation of lapped parts and to join components of built-up members. Such fillet welds may overlap, subject to the provisions of Section J2. Fillet welds in holes or slots are not to be considered plug or *slot welds*.

3. Plug and Slot Welds

3a. Effective Area

The effective shearing area of *plug* and *slot welds* shall be considered as the nominal cross-sectional area of the hole or slot in the plane of the *faying surface*.

3b. Limitations

Plug or slot welds are permitted to be used to transmit shear in *lap joints* or to prevent *buckling* or separation of lapped parts and to join component parts of *built-up members*.

The diameter of the holes for a *plug weld* shall not be less than the thickness of the part containing it plus $\frac{5}{16}$ in. (8 mm), rounded to the next larger odd $\frac{1}{16}$ in. (even mm), nor greater than the minimum diameter plus $\frac{1}{8}$ in. (3 mm) or $2\frac{1}{4}$ times the thickness of the weld.

The minimum center-to-center spacing of plug welds shall be four times the diameter of the hole.

The length of slot for a slot weld shall not exceed 10 times the thickness of the weld. The width of the slot shall be not less than the thickness of the part containing it plus $\frac{5}{16}$ in. (8 mm) rounded to the next larger odd $\frac{1}{16}$ in. (even mm), nor shall it be larger than $2\frac{1}{4}$ times the thickness of the weld. The ends of the slot shall be semicircular or shall have the corners rounded to a radius of not less than the thickness of the part containing it, except those ends which extend to the edge of the part.

The minimum spacing of lines of slot welds in a direction transverse to their length shall be four times the width of the slot. The minimum center-to-center spacing in a longitudinal direction on any line shall be two times the length of the slot.

The thickness of plug or slot welds in material $\frac{5}{8}$ in. (16 mm) or less in thickness shall be equal to the thickness of the material. In material over $\frac{5}{8}$ -in. (16 mm) thick, the thickness of the weld shall be at least one-half the thickness of the material but not less than $\frac{5}{8}$ in. (16 mm).

4. Strength

The *design strength*, ϕR_n and the *allowable strength*, R_n/Ω , of welded joints shall be the lower value of the base material strength determined according to the *limit states of tensile rupture* and *shear rupture* and the *weld metal* strength determined according to the limit state of *rupture* as follows:

For the base metal

$$R_n = F_n B M A_{BM} \quad (\text{J2-2})$$

TABLE J2.5
Available Strength of Welded Joints,
ksi (MPa)

Load Type and Direction Relative to Weld Axis	Pertinent Metal	ϕ and Ω	Nominal Stress (F_{nBM} or F_{nw}) ksi (MPa)	Effective Area (A_{BM} or A_{we}) in. ² (mm ²)	Required Filler Metal Strength Level ^{[a][b]}	
COMPLETE-JOINT-PENETRATION GROOVE WELDS						
Tension Normal to weld axis	Strength of the joint is controlled by the base metal				Matching filler metal shall be used. For T- and corner joints with backing left in place, notch tough filler metal is required. See Section J2.6.	
Compression Normal to weld axis	Strength of the joint is controlled by the base metal				Filler metal with a strength level equal to or one strength level less than matching filler metal is permitted.	
Tension or compression Parallel to weld axis	Tension or compression in parts joined parallel to a weld need not be considered in design of welds joining the parts.				Filler metal with a strength level equal to or less than matching filler metal is permitted.	
Shear	Strength of the joint is controlled by the base metal				Matching filler metal shall be used. ^[c]	
PARTIAL-JOINT-PENETRATION GROOVE WELDS INCLUDING FLARE V-GROOVE AND FLARE BEVEL GROOVE WELDS						
Tension Normal to weld axis	Base	$\phi = 0.75$ $\Omega = 2.00$	F_u	See J4	Filler metal with a strength level equal to or less than matching filler metal is permitted.	
	Weld	$\phi = 0.80$ $\Omega = 1.88$	$0.60F_{EXX}$	See J2.1a		
Compression Column to base plate and column splices designed per Section J1.4(1)	Compressive stress need not be considered in design of welds joining the parts.					
Compression Connections of members designed to bear other than columns as described in Section J1.4(2)	Base	$\phi = 0.90$ $\Omega = 1.67$	F_y	See J4		
	Weld	$\phi = 0.80$ $\Omega = 1.88$	$0.60F_{EXX}$	See J2.1a		
Compression Connections not finished-to-bear	Base	$\phi = 0.90$ $\Omega = 1.67$	F_y	See J4		
	Weld	$\phi = 0.80$ $\Omega = 1.88$	$0.90F_{EXX}$	See J2.1a		
Tension or compression Parallel to weld axis	Tension or compression in parts joined parallel to a weld need not be considered in design of welds joining the parts.					
Shear	Base	Governed by J4				
	Weld	$\phi = 0.75$ $\Omega = 2.00$	$0.60F_{EXX}$	See J2.1a		

TABLE J2.5 (continued)
Available Strength of Welded Joints,
ksi (MPa)

Load Type and Direction Relative to Weld Axis	Pertinent Metal	ϕ and Ω	Nominal Stress (F_{nBM} or F_{nw}) ksi (MPa)	Effective Area (A_{BM} or A_{we}) in. ² (mm ²)	Required Filler Metal Strength Level ^{[a][b]}
FILLET WELDS INCLUDING FILLETS IN HOLES AND SLOTS AND SKEWED T-JOINTS					
Shear	Base	Governed by J4			Filler metal with a strength level equal to or less than matching filler metal is permitted.
	Weld	$\phi = 0.75$ $\Omega = 2.00$	$0.60F_{EXX}^{[d]}$	See J2.2a	
Tension or compression Parallel to weld axis	Tension or compression in parts joined parallel to a weld need not be considered in design of welds joining the parts.				
PLUG AND SLOT WELDS					
Shear Parallel to faying surface on the effective area	Base	Governed by J4			Filler metal with a strength level equal to or less than matching filler metal is permitted.
	Weld	$\phi = 0.75$ $\Omega = 2.00$	$0.60F_{EXX}$	See J2.3a	
<p>^[a] For matching weld metal see AWS D1.1/D1.1M, Section 3.3.</p> <p>^[b] Filler metal with a strength level one strength level greater than matching is permitted.</p> <p>^[c] Filler metals with a strength level less than matching may be used for groove welds between the webs and flanges of built-up sections transferring shear loads, or in applications where high restraint is a concern. In these applications, the weld joint shall be detailed and the weld shall be designed using the thickness of the material as the effective throat, where $\phi = 0.80$, $\Omega = 1.88$ and $0.60F_{EXX}$ is the nominal strength.</p> <p>^[d] Alternatively, the provisions of Section J2.4(a) are permitted provided the deformation compatibility of the various weld elements is considered. Sections J2.4(b) and (c) are special applications of Section J2.4(a) that provide for deformation compatibility.</p>					

For the weld metal

$$R_n = F_{nw}A_{we} \quad (J2-3)$$

where

F_{nBM} = nominal stress of the base metal, ksi (MPa)

F_{nw} = nominal stress of the weld metal, ksi (MPa)

A_{BM} = cross-sectional area of the base metal, in.² (mm²)

A_{we} = effective area of the weld, in.² (mm²)

The values of ϕ , Ω , F_{nBM} and F_{nw} and limitations thereon are given in Table J2.5.

Alternatively, for *fillet welds* the *available strength* is permitted to be determined as follows:

$$\phi = 0.75 \text{ (LRFD)} \quad \Omega = 2.00 \text{ (ASD)}$$

(a) For a linear weld group with a uniform leg size, loaded through the center of gravity

$$R_n = F_{nw}A_{we} \quad (J2-4)$$

where

$$F_{nw} = 0.60F_{EXX}(1.0 + 0.50 \sin^{1.5} \theta) \quad (J2-5)$$

and

F_{EXX} = filler metal classification strength, ksi (MPa)

θ = angle of loading measured from the weld longitudinal axis, degrees

User Note: A linear weld group is one in which all elements are in a line or are parallel.

- (b) For weld elements within a weld group that are analyzed using an instantaneous center of rotation method, the components of the *nominal strength*, R_{nx} and R_{ny} , and the *nominal moment capacity*, M_n , are permitted to be determined as follows:

$$R_{nx} = \sum F_{nwx} A_{wei} \quad (J2-6a)$$

$$R_{ny} = \sum F_{nwy} A_{wei} \quad (J2-6b)$$

$$M_n = \sum [F_{nwy} A_{wei} (x_i) - F_{nwx} A_{wei} (y_i)] \quad (J2-7)$$

where

A_{wei} = effective area of weld throat of the i th weld element, in.² (mm²)

$F_{nwi} = 0.60F_{EXX}(1.0 + 0.50\sin^{1.5} \theta_i)f(p_i)$ (J2-8)

$f(p_i) = [p_i(1.9 - 0.9p_i)]^{0.3}$ (J2-9)

F_{nwi} = nominal stress in the i th weld element, ksi (MPa)

F_{nwx} = x -component of nominal stress, F_{nwi} , ksi (MPa)

F_{nwy} = y -component of nominal stress, F_{nwi} , ksi (MPa)

$p_i = \Delta_i/\Delta_{mi}$, ratio of element i deformation to its deformation at maximum stress

r_{cr} = distance from instantaneous center of rotation to weld element with minimum Δ_{ui}/r_i ratio, in. (mm)

r_i = distance from instantaneous center of rotation to i th weld element, in. (mm)

x_i = x component of r_i

y_i = y component of r_i

$\Delta_i = r_i\Delta_{ucr}/r_{cr}$ = deformation of the i th weld element at an intermediate stress level, linearly proportioned to the critical deformation based on distance from the instantaneous center of rotation, r_i , in. (mm)

$\Delta_{mi} = 0.209(\theta_i + 2)^{-0.32} w$, deformation of the i th weld element at maximum stress, in. (mm)

Δ_{ucr} = deformation of the weld element with minimum Δ_{ui}/r_i ratio at ultimate stress (rupture), usually in the element furthest from instantaneous center of rotation, in. (mm)

$\Delta_{ui} = 1.087(\theta_i + 6)^{-0.65} w \leq 0.17w$, deformation of the i th weld element at ultimate stress (rupture), in. (mm)

θ_i = angle between the longitudinal axis of i th weld element and the direction of the resultant force acting on the element, degrees

- (c) For fillet weld groups concentrically loaded and consisting of elements with a uniform leg size that are oriented both longitudinally and transversely to the direction of applied *load*, the combined strength, R_n , of the fillet weld group shall be determined as the greater of

$$(i) R_n = R_{nwl} + R_{nwt} \quad (J2-10a)$$

or

$$(ii) R_n = 0.85 R_{nwl} + 1.5 R_{nwt} \quad (J2-10b)$$

where

R_{nwl} = total nominal strength of longitudinally loaded fillet welds, as determined in accordance with Table J2.5, kips (N)

R_{nwt} = total nominal strength of transversely loaded fillet welds, as determined in accordance with Table J2.5 without the alternate in Section J2.4(a), kips (N)

5. Combination of Welds

If two or more of the general types of welds (groove, fillet, plug, slot) are combined in a single *joint*, the strength of each shall be separately computed with reference to the axis of the group in order to determine the strength of the combination.

6. Filler Metal Requirements

The choice of *filler metal* for use with *complete-joint-penetration groove welds* subject to tension normal to the effective area shall comply with the requirements for matching filler metals given in AWS D1.1/D1.1M.

User Note: The following User Note Table summarizes the AWS D1.1/D1.1M provisions for matching filler metals. Other restrictions exist. For a complete list of base metals and prequalified matching filler metals see AWS D1.1/D1.1M, Table 3.1.

Base Metal		Matching Filler Metal
A36 \leq 3/4 in. thick		60 & 70 ksi filler metal
A36 > 3/4 in. A588* A1011	A572 (Gr. 50 & 55) A913 (Gr. 50) A992 A1018	SMAW: E7015, E7016, E7018, E7028 Other processes: 70 ksi filler metal
A913	(Gr. 60 & 65)	80 ksi filler metal
<p>*For corrosion resistance and color similar to the base metal, see AWS D1.1/D1.1M, subclause 3.7.3.</p> <p>Notes: Filler metals shall meet the requirements of AWS A5.1, A5.5, A5.17, A5.18, A5.20, A5.23, A5.28 or A5.29. In joints with base metals of different strengths, use either a filler metal that matches the higher strength base metal or a filler metal that matches the lower strength and produces a low hydrogen deposit.</p>		

Filler metal with a specified minimum Charpy *V-notch toughness* of 20 ft-lb (27 J) at 40 °F (4 °C) or lower shall be used in the following *joints*:

- (1) Complete-joint-penetration groove welded T- and corner joints with steel backing left in place, subject to tension normal to the effective area, unless the joints

are designed using the *nominal strength* and *resistance factor* or *safety factor* as applicable for a *partial-joint-penetration groove weld*

- (2) Complete-joint-penetration groove welded *splices* subject to tension normal to the effective area in heavy sections as defined in Sections A3.1c and A3.1d

The manufacturer's Certificate of Conformance shall be sufficient evidence of compliance.

7. Mixed Weld Metal

When Charpy *V-notch toughness* is specified, the process consumables for all *weld metal*, tack welds, root pass and subsequent passes deposited in a *joint* shall be compatible to ensure notch-tough composite weld metal.

J3. BOLTS AND THREADED PARTS

1. High-Strength Bolts

Use of *high-strength bolts* shall conform to the provisions of the *Specification for Structural Joints Using High-Strength Bolts*, hereafter referred to as the *RCSC Specification*, as approved by the Research Council on Structural Connections, except as otherwise provided in this Specification. High-strength bolts in this Specification are grouped according to material strength as follows:

Group A—ASTM A325, A325M, F1852, A354 Grade BC, and A449

Group B—ASTM A490, A490M, F2280, and A354 Grade BD

When assembled, all *joint* surfaces, including those adjacent to the washers, shall be free of scale, except tight *mill scale*.

Bolts are permitted to be installed to the snug-tight condition when used in:

- (a) *bearing-type connections* except as noted in Section E6 or Section J1.10
- (b) tension or combined shear and tension applications, for Group A bolts only, where loosening or *fatigue* due to vibration or *load* fluctuations are not design considerations

The snug-tight condition is defined as the tightness required to bring the connected plies into firm contact. Bolts to be tightened to a condition other than snug tight shall be clearly identified on the *design drawings*.

All high-strength bolts specified on the design drawings to be used in pretensioned or slip-critical joints shall be tightened to a bolt tension not less than that given in Table J3.1 or J3.1M. Installation shall be by any of the following methods: *turn-of-nut method*, a direct-tension-indicator, twist-off-type tension-control bolt, calibrated wrench, or alternative design bolt.

User Note: There are no specific minimum or maximum tension requirements for snug-tight bolts. Fully *pretensioned bolts* such as ASTM F1852 or F2280 are permitted unless specifically prohibited on design drawings.

TABLE J3.1
Minimum Bolt Pretension, kips*

Bolt Size, in.	Group A (e.g., A325 Bolts)	Group B (e.g., A490 Bolts)
1/2	12	15
5/8	19	24
3/4	28	35
7/8	39	49
1	51	64
1 1/8	56	80
1 1/4	71	102
1 3/8	85	121
1 1/2	103	148

*Equal to 0.70 times the minimum tensile strength of bolts, rounded off to nearest kip, as specified in ASTM specifications for A325 and A490 bolts with UNC threads.

TABLE J3.1M
Minimum Bolt Pretension, kN*

Bolt Size, mm	Group A (e.g., A325M Bolts)	Group B (e.g., A490M Bolts)
M16	91	114
M20	142	179
M22	176	221
M24	205	257
M27	267	334
M30	326	408
M36	475	595

*Equal to 0.70 times the minimum tensile strength of bolts, rounded off to nearest kN, as specified in ASTM specifications for A325M and A490M bolts with UNC threads.

When bolt requirements cannot be provided within the RCSC *Specification* limitations because of requirements for lengths exceeding 12 diameters or diameters exceeding 1 1/2 in. (38 mm), bolts or threaded rods conforming to Group A or Group B materials are permitted to be used in accordance with the provisions for threaded parts in Table J3.2.

When ASTM A354 Grade BC, A354 Grade BD, or A449 bolts and threaded rods are used in slip-critical connections, the bolt geometry including the thread *pitch*, thread length, head and nut(s) shall be equal to or (if larger in diameter) proportional to that required by the RCSC *Specification*. Installation shall comply with all applicable requirements of the RCSC *Specification* with modifications as required for the increased diameter and/or length to provide the design pretension.

TABLE J3.2
Nominal Strength of Fasteners and
Threaded Parts, ksi (MPa)

Description of Fasteners	Nominal Tensile Strength, F_{nt} , ksi (MPa) ^[a]	Nominal Shear Strength in Bearing-Type Connections, F_{nv} , ksi (MPa) ^[b]
A307 bolts	45 (310)	27 (188) ^{[c] [d]}
Group A (e.g., A325) bolts, when threads are not excluded from shear planes	90 (620)	54 (372)
Group A (e.g., A325) bolts, when threads are excluded from shear planes	90 (620)	68 (469)
Group B (e.g., A490) bolts, when threads are not excluded from shear planes	113 (780)	68 (469)
Group B (e.g., A490) bolts, when threads are excluded from shear planes	113 (780)	84 (579)
Threaded parts meeting the requirements of Section A3.4, when threads are not excluded from shear planes	$0.75F_u$	$0.450F_u$
Threaded parts meeting the requirements of Section A3.4, when threads are excluded from shear planes	$0.75F_u$	$0.563F_u$

^[a] For high-strength bolts subject to tensile fatigue loading, see Appendix 3.

^[b] For end loaded connections with a fastener pattern length greater than 38 in. (965 mm), F_{nv} shall be reduced to 83.3% of the tabulated values. Fastener pattern length is the maximum distance parallel to the line of force between the centerline of the bolts connecting two parts with one faying surface.

^[c] For A307 bolts the tabulated values shall be reduced by 1% for each $1/16$ in. (2 mm) over 5 diameters of length in the grip.

^[d] Threads permitted in shear planes.

2. Size and Use of Holes

The maximum sizes of holes for bolts are given in Table J3.3 or Table J3.3M, except that larger holes, required for tolerance on location of anchor rods in concrete foundations, are permitted in *column* base details.

Standard holes or *short-slotted holes* transverse to the direction of the *load* shall be provided in accordance with the provisions of this specification, unless oversized holes, short-slotted holes parallel to the load, or *long-slotted holes* are approved

TABLE J3.3
Nominal Hole Dimensions, in.

Bolt Diameter, in.	Hole Dimensions			
	Standard (Dia.)	Oversize (Dia.)	Short-Slot (Width × Length)	Long-Slot (Width × Length)
1/2	9/16	5/8	9/16 × 11/16	9/16 × 1 1/4
5/8	11/16	13/16	11/16 × 7/8	11/16 × 1 9/16
3/4	13/16	15/16	13/16 × 1	13/16 × 1 7/8
7/8	15/16	1 1/16	15/16 × 1 1/8	15/16 × 2 3/16
1	1 1/16	1 1/4	1 1/16 × 1 5/16	1 1/16 × 2 1/2
≥ 1 1/8	$d + 1/16$	$d + 5/16$	$(d + 1/16) \times (d + 3/8)$	$(d + 1/16) \times (2.5 \times d)$

TABLE J3.3M
Nominal Hole Dimensions, mm

Bolt Diameter, mm	Hole Dimensions			
	Standard (Dia.)	Oversize (Dia.)	Short-Slot (Width × Length)	Long-Slot (Width × Length)
M16	18	20	18 × 22	18 × 40
M20	22	24	22 × 26	22 × 50
M22	24	28	24 × 30	24 × 55
M24	27 ^[a]	30	27 × 32	27 × 60
M27	30	35	30 × 37	30 × 67
M30	33	38	33 × 40	33 × 75
≥ M36	$d + 3$	$d + 8$	$(d + 3) \times (d + 10)$	$(d + 3) \times 2.5d$

^[a] Clearance provided allows the use of a 1-in. bolt if desirable.

by the *engineer of record*. Finger shims up to 1/4 in. (6 mm) are permitted in *slip-critical connections* designed on the basis of standard holes without reducing the nominal shear strength of the *fastener* to that specified for slotted holes.

Oversized holes are permitted in any or all plies of slip-critical connections, but they shall not be used in *bearing-type connections*. Hardened washers shall be installed over oversized holes in an outer ply.

Short-slotted holes are permitted in any or all plies of slip-critical or bearing-type connections. The slots are permitted without regard to direction of loading in slip-critical connections, but the length shall be normal to the direction of the load in bearing-type connections. Washers shall be installed over short-slotted holes in an outer ply; when high-strength bolts are used, such washers shall be hardened washers conforming to ASTM F436.

When Group B bolts over 1 in. (25 mm) in diameter are used in slotted or oversized holes in external plies, a single hardened washer conforming to ASTM F436, except with $5/16$ -in. (8 mm) minimum thickness, shall be used in lieu of the standard washer.

User Note: Washer requirements are provided in the RCSC *Specification*, Section 6.

Long-slotted holes are permitted in only one of the connected parts of either a slip-critical or bearing-type connection at an individual *faying surface*. Long-slotted holes are permitted without regard to direction of loading in slip-critical connections, but shall be normal to the direction of load in bearing-type connections. Where long-slotted holes are used in an outer ply, plate washers, or a continuous bar with standard holes, having a size sufficient to completely cover the slot after installation, shall be provided. In high-strength bolted connections, such plate washers or continuous bars shall be not less than $5/16$ -in. (8 mm) thick and shall be of structural grade material, but need not be hardened. If hardened washers are required for use of high-strength bolts, the hardened washers shall be placed over the outer surface of the plate washer or bar.

3. Minimum Spacing

The distance between centers of standard, oversized or slotted holes shall not be less than $2^{2/3}$ times the nominal diameter, d , of the *fastener*; a distance of $3d$ is preferred.

4. Minimum Edge Distance

The distance from the center of a standard hole to an edge of a connected part in any direction shall not be less than either the applicable value from Table J3.4 or Table J3.4M, or as required in Section J3.10. The distance from the center of an oversized or slotted hole to an edge of a connected part shall be not less than that required for a standard hole to an edge of a connected part plus the applicable increment, C_2 , from Table J3.5 or Table J3.5M.

User Note: The edge distances in Tables J3.4 and J3.4M are minimum edge distances based on standard fabrication practices and workmanship tolerances. The appropriate provisions of Sections J3.10 and J4 must be satisfied.

5. Maximum Spacing and Edge Distance

The maximum distance from the center of any bolt to the nearest edge of parts in contact shall be 12 times the thickness of the connected part under consideration, but shall not exceed 6 in. (150 mm). The longitudinal spacing of *fasteners* between elements consisting of a plate and a shape or two plates in continuous contact shall be as follows:

- (a) For painted members or unpainted members not subject to corrosion, the spacing shall not exceed 24 times the thickness of the thinner part or 12 in. (305 mm).
- (b) For unpainted members of *weathering steel* subject to atmospheric corrosion, the spacing shall not exceed 14 times the thickness of the thinner part or 7 in. (180 mm).

TABLE J3.4
Minimum Edge Distance^[a] from
Center of Standard Hole^[b] to Edge of
Connected Part, in.

Bolt Diameter, in.	Minimum Edge Distance
1/2	3/4
5/8	7/8
3/4	1
7/8	1 1/8
1	1 1/4
1 1/8	1 1/2
1 1/4	1 5/8
Over 1 1/4	1 1/4 × <i>d</i>

^[a] If necessary, lesser edge distances are permitted provided the appropriate provisions from Sections J3.10 and J4 are satisfied, but edge distances less than one bolt diameter are not permitted without approval from the engineer of record.

^[b] For oversized or slotted holes, see Table J3.5.

TABLE J3.4M
Minimum Edge Distance^[a] from
Center of Standard Hole^[b] to Edge of
Connected Part, mm

Bolt Diameter, mm	Minimum Edge Distance
16	22
20	26
22	28
24	30
27	34
30	38
36	46
Over 36	1.25 <i>d</i>

^[a] If necessary, lesser edge distances are permitted provided the appropriate provisions from Sections J3.10 and J4 are satisfied, but edge distances less than one bolt diameter are not permitted without approval from the engineer of record.

^[b] For oversized or slotted holes, see Table J3.5M.

TABLE J3.5
Values of Edge Distance Increment C_2 , in.

Nominal Diameter of Fastener, in.	Oversized Holes	Slotted Holes		
		Long Axis Perpendicular to Edge		Long Axis Parallel to Edge
		Short Slots	Long Slots ^[a]	
$\leq 7/8$	$1/16$	$1/8$	$3/4d$	0
1	$1/8$	$1/8$		
$\geq 1 1/8$	$1/8$	$3/16$		

^[a] When length of slot is less than maximum allowable (see Table J3.3), C_2 is permitted to be reduced by one-half the difference between the maximum and actual slot lengths.

TABLE J3.5M
Values of Edge Distance Increment C_2 , mm

Nominal Diameter of Fastener, mm	Oversized Holes	Slotted Holes		
		Long Axis Perpendicular to Edge		Long Axis Parallel to Edge
		Short Slots	Long Slots ^[a]	
≤ 22	2	3	$0.75d$	0
24	3	3		
≥ 27	3	5		

^[a] When length of slot is less than maximum allowable (see Table J3.3M), C_2 is permitted to be reduced by one-half the difference between the maximum and actual slot lengths.

User Note: Dimensions in (a) and (b) do not apply to elements consisting of two shapes in continuous contact.

6. Tensile and Shear Strength of Bolts and Threaded Parts

The *design tensile* or *shear strength*, ϕR_n , and the *allowable tensile* or *shear strength*, R_n/Ω , of a snug-tightened or pretensioned high-strength bolt or threaded part shall be determined according to the *limit states* of *tension rupture* and *shear rupture* as follows:

$$R_n = F_n A_b \quad (\text{J3-1})$$

$$\phi = 0.75 \text{ (LRFD)} \quad \Omega = 2.00 \text{ (ASD)}$$

where

A_b = nominal unthreaded body area of bolt or threaded part, in.² (mm²)

F_n = nominal tensile stress, F_{nt} , or shear stress, F_{nv} , from Table J3.2, ksi (MPa)

The *required tensile strength* shall include any tension resulting from *prying action* produced by deformation of the connected parts.

User Note: The *force* that can be resisted by a snug-tightened or pretensioned high-strength bolt or threaded part may be limited by the *bearing strength* at the bolt hole per Section J3.10. The effective strength of an individual *fastener* may be taken as the lesser of the fastener shear strength per Section J3.6 or the bearing strength at the bolt hole per Section J3.10. The strength of the bolt group is taken as the sum of the effective strengths of the individual fasteners.

7. Combined Tension and Shear in Bearing-Type Connections

The *available tensile strength* of a bolt subjected to combined tension and shear shall be determined according to the *limit states of tension and shear rupture* as follows:

$$R_n = F'_{nt} A_b \quad (\text{J3-2})$$

$$\phi = 0.75 \text{ (LRFD)} \quad \Omega = 2.00 \text{ (ASD)}$$

where

F'_{nt} = nominal tensile *stress* modified to include the effects of shear stress, ksi (MPa)

$$F'_{nt} = 1.3F_{nt} - \frac{F_{nt}}{\phi F_{nv}} f_{rv} \leq F_{nt} \quad (\text{LRFD}) \quad (\text{J3-3a})$$

$$F'_{nt} = 1.3F_{nt} - \frac{\Omega F_{nt}}{F_{nv}} f_{rv} \leq F_{nt} \quad (\text{ASD}) \quad (\text{J3-3b})$$

F_{nt} = nominal tensile stress from Table J3.2, ksi (MPa)

F_{nv} = nominal shear stress from Table J3.2, ksi (MPa)

f_{rv} = required shear stress using *LRFD* or *ASD load combinations*, ksi (MPa)

The available shear stress of the *fastener* shall equal or exceed the required shear stress, f_{rv} .

User Note: Note that when the required stress, f , in either shear or tension, is less than or equal to 30% of the corresponding *available stress*, the effects of combined *stress* need not be investigated. Also note that Equations J3-3a and J3-3b can be rewritten so as to find a nominal shear stress, F'_{nv} , as a function of the required tensile stress, f_t .

8. High-Strength Bolts in Slip-Critical Connections

Slip-critical connections shall be designed to prevent *slip* and for the *limit states of bearing-type connections*. When slip-critical bolts pass through *fillers*, all surfaces subject to slip shall be prepared to achieve design slip resistance.

The available slip resistance for the limit state of slip shall be determined as follows:

$$R_n = \mu D_u h_f T_b n_s \quad (J3-4)$$

- (a) For standard size and short-slotted holes perpendicular to the direction of the *load*

$$\phi = 1.00 \text{ (LRFD)} \quad \Omega = 1.50 \text{ (ASD)}$$

- (b) For oversized and short-slotted holes parallel to the direction of the *load*

$$\phi = 0.85 \text{ (LRFD)} \quad \Omega = 1.76 \text{ (ASD)}$$

- (c) For long-slotted holes

$$\phi = 0.70 \text{ (LRFD)} \quad \Omega = 2.14 \text{ (ASD)}$$

where

μ = mean slip coefficient for Class A or B surfaces, as applicable, and determined as follows, or as established by tests:

- (i) For Class A surfaces (unpainted clean *mill scale* steel surfaces or surfaces with Class A coatings on blast-cleaned steel or hot-dipped galvanized and roughened surfaces)

$$\mu = 0.30$$

- (ii) For Class B surfaces (unpainted blast-cleaned steel surfaces or surfaces with Class B coatings on blast-cleaned steel)

$$\mu = 0.50$$

$D_u = 1.13$, a multiplier that reflects the ratio of the mean installed bolt pretension to the specified minimum bolt pretension. The use of other values may be approved by the *engineer of record*.

T_b = minimum *fastener* tension given in Table J3.1, kips, or Table J3.1M, kN

h_f = factor for fillers, determined as follows:

- (i) Where there are no fillers or where bolts have been added to distribute loads in the filler

$$h_f = 1.0$$

- (ii) Where bolts have not been added to distribute the *load* in the filler:

- (a) For one filler between connected parts

$$h_f = 1.0$$

- (b) For two or more fillers between connected parts

$$h_f = 0.85$$

n_s = number of slip planes required to permit the connection to slip

9. Combined Tension and Shear in Slip-Critical Connections

When a *slip-critical connection* is subjected to an applied tension that reduces the net clamping force, the available *slip* resistance per bolt, from Section J3.8, shall be multiplied by the factor, k_{sc} , as follows:

$$k_{sc} = 1 - \frac{T_u}{D_u T_b n_b} \quad (\text{LRFD}) \quad (\text{J3-5a})$$

$$k_{sc} = 1 - \frac{1.5T_a}{D_u T_b n_b} \quad (\text{ASD}) \quad (\text{J3-5b})$$

where

T_a = required tension force using *ASD load combinations*, kips (kN)

T_u = required tension force using *LRFD load combinations*, kips (kN)

n_b = number of bolts carrying the applied tension

10. Bearing Strength at Bolt Holes

The *available bearing strength*, ϕR_n and R_n/Ω , at bolt holes shall be determined for the *limit state of bearing* as follows:

$$\phi = 0.75 \quad (\text{LRFD}) \quad \Omega = 2.00 \quad (\text{ASD})$$

The nominal bearing strength of the connected material, R_n , is determined as follows:

(a) For a bolt in a *connection* with standard, oversized and short-slotted holes, independent of the direction of loading, or a long-slotted hole with the slot parallel to the direction of the bearing *force*

(i) When deformation at the bolt hole at *service load* is a design consideration

$$R_n = 1.2l_c t F_u \leq 2.4dt F_u \quad (\text{J3-6a})$$

(ii) When deformation at the bolt hole at service load is not a design consideration

$$R_n = 1.5l_c t F_u \leq 3.0dt F_u \quad (\text{J3-6b})$$

(b) For a bolt in a connection with long-slotted holes with the slot perpendicular to the direction of force

$$R_n = 1.0l_c t F_u \leq 2.0dt F_u \quad (\text{J3-6c})$$

(c) For connections made using bolts that pass completely through an unstiffened box member or *HSS*, see Section J7 and Equation J7-1;

where

F_u = *specified minimum tensile strength* of the connected material, ksi (MPa)

d = nominal bolt diameter, in. (mm)

l_c = clear distance, in the direction of the force, between the edge of the hole and the edge of the adjacent hole or edge of the material, in. (mm)

t = thickness of connected material, in. (mm)

For connections, the bearing resistance shall be taken as the sum of the bearing resistances of the individual bolts.

Bearing strength shall be checked for both bearing-type and *slip-critical connections*. The use of oversized holes and short- and long-slotted holes parallel to the line of force is restricted to slip-critical connections per Section J3.2.

User Note: The effective strength of an individual *fastener* is the lesser of the fastener shear strength per Section J3.6 or the bearing strength at the bolt hole per Section J3.10. The strength of the bolt group is the sum of the effective strengths of the individual fasteners.

11. Special Fasteners

The *nominal strength* of special *fasteners* other than the bolts presented in Table J3.2 shall be verified by tests.

12. Tension Fasteners

When bolts or other *fasteners* in tension are attached to an unstiffened box or *HSS* wall, the strength of the wall shall be determined by rational analysis.

J4. AFFECTED ELEMENTS OF MEMBERS AND CONNECTING ELEMENTS

This section applies to elements of members at *connections* and connecting elements, such as plates, gussets, angles and brackets.

1. Strength of Elements in Tension

The *design strength*, ϕR_n , and the *allowable strength*, R_n/Ω , of affected and connecting elements loaded in tension shall be the lower value obtained according to the *limit states of tensile yielding and tensile rupture*.

(a) For tensile yielding of connecting elements

$$R_n = F_y A_g \quad (J4-1)$$

$$\phi = 0.90 \text{ (LRFD)} \quad \Omega = 1.67 \text{ (ASD)}$$

(b) For tensile rupture of connecting elements

$$R_n = F_u A_e \quad (J4-2)$$

$$\phi = 0.75 \text{ (LRFD)} \quad \Omega = 2.00 \text{ (ASD)}$$

where

A_e = *effective net area* as defined in Section D3, in.² (mm²); for bolted *splice* plates, $A_e = A_n \leq 0.85A_g$.

User Note: The effective net area of the connection plate may be limited due to *stress* distribution as calculated by methods such as the Whitmore section.

2. Strength of Elements in Shear

The available shear strength of affected and connecting elements in shear shall be the lower value obtained according to the *limit states of shear yielding and shear rupture*:

(a) For shear yielding of the element:

$$R_n = 0.60F_y A_{gv} \quad (J4-3)$$

$$\phi = 1.00 \text{ (LRFD)} \quad \Omega = 1.50 \text{ (ASD)}$$

where

A_{gv} = gross area subject to shear, in.² (mm²)

(b) For shear rupture of the element:

$$R_n = 0.60F_u A_{nv} \quad (J4-4)$$

$$\phi = 0.75 \text{ (LRFD)} \quad \Omega = 2.00 \text{ (ASD)}$$

where

A_{nv} = net area subject to shear, in.² (mm²)

3. Block Shear Strength

The *available strength* for the *limit state of block shear rupture* along a shear failure path or paths and a perpendicular tension failure path shall be taken as

$$R_n = 0.60F_u A_{nv} + U_{bs} F_u A_{nt} \leq 0.60F_y A_{gv} + U_{bs} F_u A_{nt} \quad (J4-5)$$

$$\phi = 0.75 \text{ (LRFD)} \quad \Omega = 2.00 \text{ (ASD)}$$

where

A_{nt} = net area subject to tension, in.² (mm²)

Where the tension *stress* is uniform, $U_{bs} = 1$; where the tension stress is nonuniform, $U_{bs} = 0.5$.

User Note: Typical cases where U_{bs} should be taken equal to 0.5 are illustrated in the Commentary.

4. Strength of Elements in Compression

The *available strength* of connecting elements in compression for the *limit states of yielding and buckling* shall be determined as follows:

(a) When $KL/r \leq 25$

$$P_n = F_y A_g \quad (J4-6)$$

$$\phi = 0.90 \text{ (LRFD)} \quad \Omega = 1.67 \text{ (ASD)}$$

(b) When $KL/r > 25$, the provisions of Chapter E apply.

5. Strength of Elements in Flexure

The available flexural strength of affected elements shall be the lower value obtained according to the *limit states* of flexural yielding, local buckling, flexural lateral-torsional buckling and flexural rupture.

J5. FILLERS

1. Fillers in Welded Connections

Whenever it is necessary to use *fillers* in joints required to transfer applied force, the fillers and the connecting welds shall conform to the requirements of Section J5.1a or Section J5.1b, as applicable.

1a. Thin Fillers

Fillers less than $\frac{1}{4}$ in. (6 mm) thick shall not be used to transfer *stress*. When the thickness of the fillers is less than $\frac{1}{4}$ in. (6 mm), or when the thickness of the filler is $\frac{1}{4}$ in. (6 mm) or greater but not adequate to transfer the applied force between the connected parts, the filler shall be kept flush with the edge of the outside connected part, and the size of the weld shall be increased over the required size by an amount equal to the thickness of the filler.

1b. Thick Fillers

When the thickness of the *fillers* is adequate to transfer the applied force between the connected parts, the filler shall extend beyond the edges of the outside connected base metal. The welds joining the outside connected base metal to the filler shall be sufficient to transmit the force to the filler and the area subjected to the applied force in the filler shall be adequate to avoid overstressing the filler. The welds joining the filler to the inside connected base metal shall be adequate to transmit the applied force.

2. Fillers in Bolted Connections

When a bolt that carries *load* passes through *fillers* that are equal to or less than $\frac{1}{4}$ in. (6 mm) thick, the shear strength shall be used without reduction. When a bolt that carries load passes through fillers that are greater than $\frac{1}{4}$ in. (6 mm) thick, one of the following requirements shall apply:

- (a) The shear strength of the bolts shall be multiplied by the factor

$$1 - 0.4(t - 0.25)$$

$$[\text{S.I.: } 1 - 0.0154(t - 6)]$$

but not less than 0.85, where t is the total thickness of the fillers;

- (b) The fillers shall be extended beyond the *joint* and the filler extension shall be secured with enough bolts to uniformly distribute the total *force* in the connected element over the combined cross section of the connected element and the fillers;
- (c) The size of the joint shall be increased to accommodate a number of bolts that is equivalent to the total number required in (b) above; or

- (d) The joint shall be designed to prevent *slip* in accordance with Section J3.8 using either Class B surfaces or Class A surfaces with turn-of-nut tightening.

J6. SPLICES

Groove-welded *splices* in *plate girders* and *beams* shall develop the *nominal strength* of the smaller spliced section. Other types of splices in cross sections of plate girders and beams shall develop the strength required by the forces at the point of the splice.

J7. BEARING STRENGTH

The *design bearing strength*, ϕR_n , and the *allowable bearing strength*, R_n/Ω , of surfaces in contact shall be determined for the *limit state of bearing (local compressive yielding)* as follows:

$$\phi = 0.75 \text{ (LRFD)} \quad \Omega = 2.00 \text{ (ASD)}$$

The *nominal bearing strength*, R_n , shall be determined as follows:

- (a) For *finished surfaces*, pins in reamed, drilled, or bored holes, and ends of *fitted bearing stiffeners*

$$R_n = 1.8F_y A_{pb} \quad (\text{J7-1})$$

where

A_{pb} = projected area in bearing, in.² (mm²)

F_y = specified minimum yield stress, ksi (MPa)

- (b) For *expansion rollers* and *rockers*

- (i) When $d \leq 25$ in. (635 mm)

$$R_n = 1.2(F_y - 13)l_b d / 20 \quad (\text{J7-2})$$

$$\text{(S.I.: } R_n = 1.2(F_y - 90)l_b d / 20) \quad (\text{J7-2M})$$

- (ii) When $d > 25$ in. (635 mm)

$$R_n = 6.0(F_y - 13)l_b \sqrt{d} / 20 \quad (\text{J7-3})$$

$$\text{(S.I.: } R_n = 30.2(F_y - 90)l_b \sqrt{d} / 20) \quad (\text{J7-3M})$$

where

d = diameter, in. (mm)

l_b = length of bearing, in. (mm)

J8. COLUMN BASES AND BEARING ON CONCRETE

Proper provision shall be made to transfer the *column loads* and moments to the footings and foundations.

In the absence of code regulations, the *design bearing strength*, $\phi_c P_p$, and the *allowable bearing strength*, P_p/Ω_c , for the *limit state of concrete crushing* are permitted to be taken as follows:

$$\phi_c = 0.65 \text{ (LRFD)} \quad \Omega_c = 2.31 \text{ (ASD)}$$

The *nominal bearing strength*, P_p , is determined as follows:

(a) On the full area of a concrete support:

$$P_p = 0.85 f'_c A_1 \quad (\text{J8-1})$$

(b) On less than the full area of a concrete support:

$$P_p = 0.85 f'_c A_1 \sqrt{A_2 / A_1} \leq 1.7 f'_c A_1 \quad (\text{J8-2})$$

where

A_1 = area of steel concentrically bearing on a concrete support, in.² (mm²)

A_2 = maximum area of the portion of the supporting surface that is geometrically similar to and concentric with the loaded area, in.² (mm²)

f'_c = specified compressive strength of concrete, ksi (MPa)

J9. ANCHOR RODS AND EMBEDMENTS

Anchor rods shall be designed to provide the required resistance to *loads* on the completed structure at the base of *columns* including the net tensile components of any bending moment that may result from load combinations stipulated in Section B2. The anchor rods shall be designed in accordance with the requirements for threaded parts in Table J3.2.

User Note: ASTM F1554 anchor rods may be furnished in accordance to product specifications with a body diameter less than the nominal diameter. Load effects such as bending and elongation should be calculated based on minimum diameters permitted by the product specification. See ASTM F1554 and the table, “Applicable ASTM Specifications for Various Types of Structural Fasteners,” in Part 2 of the AISC *Steel Construction Manual*.

Design of column bases and anchor rods for the transfer of forces to the concrete foundation including *bearing* against the concrete elements shall satisfy the requirements of ACI 318 or ACI 349.

User Note: When columns are required to resist a horizontal force at the base plate, bearing against the concrete elements should be considered.

When anchor rods are used to resist horizontal forces, hole size, anchor rod setting tolerance, and the horizontal movement of the column shall be considered in the design.

Larger oversized holes and slotted holes are permitted in base plates when adequate bearing is provided for the nut by using ASTM F844 washers or plate washers to bridge the hole.

User Note: The permitted hole sizes, corresponding washer dimensions and nuts are given in the AISC *Steel Construction Manual* and ASTM F1554.

User Note: See ACI 318 for embedment design and for shear friction design. See OSHA for special erection requirements for anchor rods.

J10. FLANGES AND WEBS WITH CONCENTRATED FORCES

This section applies to *single-* and *double-concentrated forces* applied normal to the flange(s) of wide flange sections and similar *built-up shapes*. A single-concentrated force can be either tensile or compressive. Double-concentrated forces are one tensile and one compressive and form a couple on the same side of the loaded member.

When the *required strength* exceeds the *available strength* as determined for the *limit states* listed in this section, *stiffeners* and/or *doublers* shall be provided and shall be sized for the difference between the required strength and the available strength for the applicable limit state. Stiffeners shall also meet the design requirements in Section J10.8. Doublers shall also meet the design requirement in Section J10.9.

User Note: See Appendix 6.3 for requirements for the ends of cantilever members.

Stiffeners are required at *unframed ends* of *beams* in accordance with the requirements of Section J10.7.

1. Flange Local Bending

This section applies to tensile *single-concentrated forces* and the tensile component of *double-concentrated forces*.

The *design strength*, ϕR_n , and the *allowable strength*, R_n/Ω , for the *limit state* of flange *local bending* shall be determined as follows:

$$R_n = 6.25F_{yf}t_f^2 \quad (J10-1)$$

$$\phi = 0.90 \text{ (LRFD)} \quad \Omega = 1.67 \text{ (ASD)}$$

where

F_{yf} = specified minimum yield stress of the flange, ksi (MPa)
 t_f = thickness of the loaded flange, in. (mm)

If the length of loading across the member flange is less than $0.15b_f$, where b_f is the member flange width, Equation J10-1 need not be checked.

When the concentrated force to be resisted is applied at a distance from the member end that is less than $10t_f$, R_n shall be reduced by 50%.

When required, a pair of *transverse stiffeners* shall be provided.

2. Web Local Yielding

This section applies to *single-concentrated forces* and both components of *double-concentrated forces*.

The *available strength* for the *limit state* of web *local yielding* shall be determined as follows:

$$\phi = 1.00 \text{ (LRFD)} \quad \Omega = 1.50 \text{ (ASD)}$$

The *nominal strength*, R_n , shall be determined as follows:

- (a) When the concentrated *force* to be resisted is applied at a distance from the member end that is greater than the depth of the member, d ,

$$R_n = F_{yw}t_w(5k + l_b) \quad (\text{J10-2})$$

- (b) When the concentrated force to be resisted is applied at a distance from the member end that is less than or equal to the depth of the member, d ,

$$R_n = F_{yw}t_w(2.5k + l_b) \quad (\text{J10-3})$$

where

F_{yw} = specified minimum yield stress of the web material, ksi (MPa)

k = distance from outer face of the flange to the web toe of the fillet, in. (mm)

l_b = length of bearing (not less than k for end *beam* reactions), in. (mm)

t_w = thickness of web, in. (mm)

When required, a pair of *transverse stiffeners* or a *doubler* plate shall be provided.

3. Web Local Crippling

This section applies to compressive *single-concentrated forces* or the compressive component of *double-concentrated forces*.

The *available strength* for the *limit state* of web *local crippling* shall be determined as follows:

$$\phi = 0.75 \text{ (LRFD)} \quad \Omega = 2.00 \text{ (ASD)}$$

The *nominal strength*, R_n , shall be determined as follows:

- (a) When the concentrated compressive *force* to be resisted is applied at a distance from the member end that is greater than or equal to $d/2$:

$$R_n = 0.80t_w^2 \left[1 + 3 \left(\frac{l_b}{d} \right) \left(\frac{t_w}{t_f} \right)^{1.5} \right] \sqrt{\frac{EF_{yw}t_f}{t_w}} \quad (\text{J10-4})$$

- (b) When the concentrated compressive force to be resisted is applied at a distance from the member end that is less than $d/2$:

(i) For $l_b/d \leq 0.2$

$$R_n = 0.40t_w^2 \left[1 + 3 \left(\frac{l_b}{d} \right) \left(\frac{t_w}{t_f} \right)^{1.5} \right] \sqrt{\frac{EF_{yw}t_f}{t_w}} \quad (\text{J10-5a})$$

(ii) For $l_b/d > 0.2$

$$R_n = 0.40t_w^2 \left[1 + \left(\frac{4l_b}{d} - 0.2 \right) \left(\frac{t_w}{t_f} \right)^{1.5} \right] \sqrt{\frac{EF_{yw}t_f}{t_w}} \quad (\text{J10-5b})$$

where

d = full nominal depth of the section, in. (mm)

When required, a *transverse stiffener*, a pair of transverse stiffeners, or a *doubler* plate extending at least one-half the depth of the web shall be provided.

4. Web Sidesway Buckling

This section applies only to compressive *single-concentrated forces* applied to members where relative lateral movement between the loaded compression flange and the tension flange is not restrained at the point of application of the concentrated force.

The *available strength* of the web for the *limit state* of *sidesway buckling* shall be determined as follows:

$$\phi = 0.85 \text{ (LRFD)} \quad \Omega = 1.76 \text{ (ASD)}$$

The *nominal strength*, R_n , shall be determined as follows:

(a) If the compression flange is restrained against rotation

(i) When $(h/t_w)/(L_b/b_f) \leq 2.3$

$$R_n = \frac{C_r t_w^3 t_f}{h^2} \left[1 + 0.4 \left(\frac{h/t_w}{L_b/b_f} \right)^3 \right] \quad (\text{J10-6})$$

(ii) When $(h/t_w)/(L_b/b_f) > 2.3$, the limit state of *web sidesway buckling* does not apply.

When the *required strength* of the web exceeds the available strength, local *lateral bracing* shall be provided at the tension flange or either a pair of *transverse stiffeners* or a *doubler* plate shall be provided.

(b) If the compression flange is not restrained against rotation

(i) When $(h/t_w)/(L_b/b_f) \leq 1.7$

$$R_n = \frac{C_r t_w^3 t_f}{h^2} \left[0.4 \left(\frac{h/t_w}{L_b/b_f} \right)^3 \right] \quad (\text{J10-7})$$

- (ii) When $(h/t_w)/(L_b/b_f) > 1.7$, the limit state of web sidesway buckling does not apply.

When the required strength of the web exceeds the available strength, local lateral bracing shall be provided at both flanges at the point of application of the concentrated forces.

In Equations J10-6 and J10-7, the following definitions apply:

$C_r = 960,000$ ksi (6.62×10^6 MPa) when $M_u < M_y$ (LRFD) or $1.5M_a < M_y$ (ASD) at the location of the force

$= 480,000$ ksi (3.31×10^6 MPa) when $M_u \geq M_y$ (LRFD) or $1.5M_a \geq M_y$ (ASD) at the location of the force

$L_b =$ largest laterally *unbraced length* along either flange at the point of *load*, in. (mm)

$M_a =$ required flexural strength using *ASD load combinations*, kip-in. (N-mm)

$M_u =$ required flexural strength using *LRFD load combinations*, kip-in. (N-mm)

$b_f =$ width of flange, in. (mm)

$h =$ clear distance between flanges less the fillet or corner radius for rolled shapes; distance between adjacent lines of *fasteners* or the clear distance between flanges when welds are used for *built-up shapes*, in. (mm)

User Note: For determination of adequate restraint, refer to Appendix 6.

5. Web Compression Buckling

This section applies to a pair of compressive *single-concentrated forces* or the compressive components in a pair of *double-concentrated forces*, applied at both flanges of a member at the same location.

The *available strength* for the *limit state* of web *local buckling* shall be determined as follows:

$$R_n = \frac{24t_w^3 \sqrt{EF_{yw}}}{h} \quad (\text{J10-8})$$

$$\phi = 0.90 \text{ (LRFD)} \quad \Omega = 1.67 \text{ (ASD)}$$

When the pair of concentrated compressive *forces* to be resisted is applied at a distance from the member end that is less than $d/2$, R_n shall be reduced by 50%.

When required, a single *transverse stiffener*, a pair of transverse stiffeners, or a *double* plate extending the full depth of the web shall be provided.

6. Web Panel Zone Shear

This section applies to *double-concentrated forces* applied to one or both flanges of a member at the same location.

The *available strength* of the web *panel zone* for the *limit state* of *shear yielding* shall be determined as follows:

$$\phi = 0.90 \text{ (LRFD)} \quad \Omega = 1.67 \text{ (ASD)}$$

The *nominal strength*, R_n , shall be determined as follows:

(a) When the effect of panel-zone deformation on frame *stability* is not considered in the analysis:

(i) For $P_r \leq 0.4P_c$

$$R_n = 0.60F_y d_c t_w \quad (\text{J10-9})$$

(ii) For $P_r > 0.4P_c$

$$R_n = 0.60F_y d_c t_w \left(1.4 - \frac{P_r}{P_c} \right) \quad (\text{J10-10})$$

(b) When frame stability, including plastic panel-zone deformation, is considered in the analysis:

(i) For $P_r \leq 0.75P_c$

$$R_n = 0.60F_y d_c t_w \left(1 + \frac{3b_{cf} t_{cf}^2}{d_b d_c t_w} \right) \quad (\text{J10-11})$$

(ii) For $P_r > 0.75P_c$

$$R_n = 0.60F_y d_c t_w \left(1 + \frac{3b_{cf} t_{cf}^2}{d_b d_c t_w} \right) \left(1.9 - \frac{1.2P_r}{P_c} \right) \quad (\text{J10-12})$$

In Equations J10-9 through J10-12, the following definitions apply:

A_g = gross cross-sectional area of member, in.² (mm²)

b_{cf} = width of *column* flange, in. (mm)

d_b = depth of *beam*, in. (mm)

d_c = depth of *column*, in. (mm)

F_y = *specified minimum yield stress* of the column web, ksi (MPa)

$P_c = P_y$, kips (N) (LRFD)

$P_c = 0.60P_y$, kips (N) (ASD)

P_r = *required axial strength* using *LRFD* or *ASD load combinations*, kips (N)

$P_y = F_y A_g$, *axial yield strength* of the column, kips (N)

t_{cf} = thickness of *column* flange, in. (mm)

t_w = thickness of *column* web, in. (mm)

When required, *doubler* plate(s) or a pair of *diagonal stiffeners* shall be provided within the boundaries of the rigid connection whose webs lie in a common plane.

See Section J10.9 for doubler plate design requirements.

7. Unframed Ends of Beams and Girders

At *unframed ends of beams and girders* not otherwise restrained against rotation about their longitudinal axes, a pair of *transverse stiffeners*, extending the full depth of the web, shall be provided.

8. Additional Stiffener Requirements for Concentrated Forces

Stiffeners required to resist tensile concentrated *forces* shall be designed in accordance with the requirements of Section J4.1 and welded to the loaded flange and the web. The welds to the flange shall be sized for the difference between the *required strength* and *available strength*. The stiffener to web welds shall be sized to transfer to the web the algebraic difference in tensile force at the ends of the stiffener.

Stiffeners required to resist compressive concentrated forces shall be designed in accordance with the requirements in Section J4.4 and shall either bear on or be welded to the loaded flange and welded to the web. The welds to the flange shall be sized for the difference between the required strength and the applicable *limit state* strength. The weld to the web shall be sized to transfer to the web the algebraic difference in compression force at the ends of the stiffener. For *fitted bearing stiffeners*, see Section J7.

Transverse full depth bearing stiffeners for compressive forces applied to a *beam or plate girder* flange(s) shall be designed as axially compressed members (*columns*) in accordance with the requirements of Section E6.2 and Section J4.4. The member properties shall be determined using an effective length of $0.75h$ and a cross section composed of two stiffeners, and a strip of the web having a width of $25t_w$ at interior stiffeners and $12t_w$ at the ends of members. The weld connecting full depth bearing stiffeners to the web shall be sized to transmit the difference in compressive force at each of the stiffeners to the web.

Transverse and diagonal stiffeners shall comply with the following additional requirements:

- (1) The width of each stiffener plus one-half the thickness of the column web shall not be less than one-third of the flange or moment connection plate width delivering the concentrated force.
- (2) The thickness of a stiffener shall not be less than one-half the thickness of the flange or moment connection plate delivering the concentrated *load*, nor less than the width divided by 16.
- (3) Transverse stiffeners shall extend a minimum of one-half the depth of the member except as required in Section J10.5 and Section J10.7.

9. Additional Doubler Plate Requirements for Concentrated Forces

Doubler plates required for compression strength shall be designed in accordance with the requirements of Chapter E.

Doubler plates required for *tensile strength* shall be designed in accordance with the requirements of Chapter D.

Doubler plates required for shear strength (see Section J10.6) shall be designed in accordance with the provisions of Chapter G.

Doubler plates shall comply with the following additional requirements:

- (1) The thickness and extent of the doubler plate shall provide the additional material necessary to equal or exceed the strength requirements.
- (2) The doubler plate shall be welded to develop the proportion of the total force transmitted to the doubler plate.

CHAPTER K

DESIGN OF HSS AND BOX MEMBER CONNECTIONS

This chapter addresses connections to *HSS* members and box sections of uniform wall thickness.

User Note: Connection strength is often governed by the size of HSS members, especially the wall thickness of truss chords, and this must be considered in the initial design.

The chapter is organized as follows:

- K1. Concentrated Forces on HSS
- K2. HSS-to-HSS Truss Connections
- K3. HSS-to-HSS Moment Connections
- K4. Welds of Plates and Branches to Rectangular HSS

User Note: See also Chapter J for additional requirements for bolting to HSS. See Section J3.10(c) for through-bolts.

User Note: Connection parameters must be within the limits of applicability. *Limit states* need only be checked when connection geometry or loading is within the parameters given in the description of the limit state.

K1. CONCENTRATED FORCES ON HSS

The *design strength*, ϕR_n , and the *allowable strength*, R_n/Ω , of *connections* shall be determined in accordance with the provisions of this chapter and the provisions of Section B3.6.

1. Definitions of Parameters

- A_g = gross cross-sectional area of member, in.² (mm²)
- B = overall width of rectangular *HSS* member, measured 90° to the plane of the connection, in. (mm)
- B_p = width of plate, measured 90° to the plane of the connection, in. (mm)
- D = outside diameter of round HSS, in. (mm)
- F_c = *available stress*, ksi (MPa)
= F_y for LRFD; $0.60F_y$ for ASD
- F_y = *specified minimum yield stress* of HSS member material, ksi (MPa)
- F_{yp} = *specified minimum yield stress* of plate material, ksi (MPa)
- F_u = *specified minimum tensile strength* of HSS member material, ksi (MPa)
- H = overall height of rectangular HSS member, measured in the plane of the connection, in. (mm)

- S = elastic section modulus of member, in.³ (mm³)
 l_b = bearing length of the *load*, measured parallel to the axis of the HSS member (or measured across the width of the HSS in the case of loaded cap plates), in. (mm)
 t = *design wall thickness* of HSS member, in. (mm)
 t_p = thickness of plate, in. (mm)

2. Round HSS

The *available strength* of connections with concentrated loads and within the limits in Table K1.1A shall be taken as shown in Table K1.1.

3. Rectangular HSS

The *available strength* of connections with concentrated *loads* and within the limits in Table K1.2A shall be taken as the lowest value of the applicable *limit states* shown in Table K1.2.

K2. HSS-TO-HSS TRUSS CONNECTIONS

The *design strength*, ϕP_n , and the *allowable strength*, P_n/Ω , of *connections* shall be determined in accordance with the provisions of this chapter and the provisions of Section B3.6.

HSS-to-HSS truss connections are defined as connections that consist of one or more *branch members* that are directly welded to a continuous chord that passes through the connection and shall be classified as follows:

- (a) When the *punching load*, $P_r \sin\theta$, in a branch member is equilibrated by *beam shear* in the *chord member*, the connection shall be classified as a *T-connection* when the branch is perpendicular to the chord, and a *Y-connection* otherwise.
- (b) When the *punching load*, $P_r \sin\theta$, in a branch member is essentially equilibrated (within 20%) by *loads* in other branch member(s) on the same side of the connection, the connection shall be classified as a *K-connection*. The relevant gap is between the primary branch members whose loads equilibrate. An N-connection can be considered as a type of K-connection.

User Note: A K-connection with one branch perpendicular to the chord is often called an N-connection.

- (c) When the *punching load*, $P_r \sin\theta$, is transmitted through the chord member and is equilibrated by branch member(s) on the opposite side, the connection shall be classified as a *cross-connection*.
- (d) When a connection has more than two primary branch members, or branch members in more than one plane, the connection shall be classified as a general or multiplanar connection.

When branch members transmit part of their load as K-connections and part of their load as T-, Y- or cross-connections, the adequacy of the connections shall be determined by interpolation on the proportion of the *available strength* of each in total.

TABLE K1.1
Available Strengths of
Plate-to-Round HSS Connections

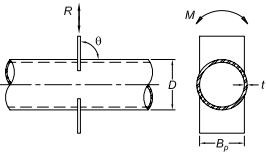
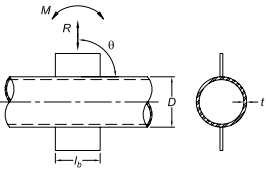
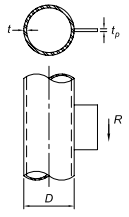
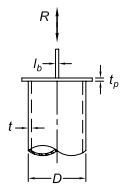
Connection Type	Connection Available Strength	Plate Bending	
		In-Plane	Out-of-Plane
Transverse Plate T- and Cross-Connections 	Limit State: HSS Local Yielding Plate Axial Load $R_n \sin \theta = F_y t^2 \left(\frac{5.5}{1 - 0.81 \frac{B_p}{D}} \right) Q_f \quad (K1-1)$ $\phi = 0.90 \text{ (LRFD)} \quad \Omega = 1.67 \text{ (ASD)}$	—	$M_n = 0.5 B_p R_n$
Longitudinal Plate T-, Y- and Cross-Connections 	Limit State: HSS Plastification Plate Axial Load $R_n \sin \theta = 5.5 F_y t^2 \left(1 + 0.25 \frac{b}{D} \right) Q_f \quad (K1-2)$ $\phi = 0.90 \text{ (LRFD)} \quad \Omega = 1.67 \text{ (ASD)}$	$M_n = 0.8 I_b R_n$	—
Longitudinal Plate T-Connections 	Limit States: Plate Limit States and HSS Punching Shear Plate Shear Load For R_n , see Chapter J. Additionally, the following relationship shall be met: $t_p \leq \frac{F_u}{F_{yp}} t \quad (K1-3)$	—	—
Cap Plate Connections 	Limit State: Local Yielding of HSS Axial Load $R_n = 2 F_y t (5 t_p + l_b) \leq F_y A \quad (K1-4)$ $\phi = 1.00 \text{ (LRFD)} \quad \Omega = 1.50 \text{ (ASD)}$	—	—

FUNCTIONS

$Q_f = 1$ for HSS (connecting surface) in tension
 $= 1.0 - 0.3U (1 + U)$ for HSS (connecting surface) in compression (K1-5)

$$U = \left| \frac{P_{ro}}{F_c A_g} + \frac{M_{ro}}{F_c S} \right|$$
 where P_{ro} and M_{ro} are determined on the side of the joint that has the lower compression stress. P_{ro} and M_{ro} refer to required strengths in the HSS. (K1-6)

$P_{ro} = P_u$ for LRFD; P_a for ASD. $M_{ro} = M_u$ for LRFD; M_a for ASD.

TABLE K1.1A
Limits of Applicability of Table K1.1

Plate load angle:	$\theta \geq 30^\circ$	
HSS wall	$D/t \leq 50$ for T-connections under branch plate axial load or bending	
slenderness:	$D/t \leq 40$ for cross-connections under branch plate axial load or bending	
	$D/t \leq 0.11E/F_y$ under branch plate shear loading	
	$D/t \leq 0.11E/F_y$ for cap plate connections in compression	
Width ratio:	$0.2 < B_p/D \leq 1.0$ for transverse branch plate connections	
Material strength:	$F_y \leq 52$ ksi (360 MPa)	
Ductility:	$F_y/F_u \leq 0.8$	Note: ASTM A500 Grade C is acceptable.

TABLE K1.2
Available Strengths of
Plate-to-Rectangular HSS Connections

Connection Type	Connection Available Strength
Transverse Plate T- and Cross-Connections, Under Plate Axial Load  where $\beta = \frac{B_p}{B}$	Limit State: Local Yielding of Plate, For All β $R_n = \frac{10}{B/t} F_y t B_p \leq F_{yp} t_p B_p \quad (K1-7)$ $\phi = 0.95$ (LRFD) $\Omega = 1.58$ (ASD)
	Limit State: HSS Shear Yielding (Punching), When $0.85B \leq B_p \leq B - 2t$ $R_n = 0.6 F_y t (2t_p + 2B_{sp}) \quad (K1-8)$ $\phi = 0.95$ (LRFD) $\Omega = 1.58$ (ASD)
	Limit State: Local Yielding of HSS Sidewalls, When $\beta = 1.0$ $R_n = 2 F_y t (5k + l_b) \quad (K1-9)$ $\phi = 1.00$ (LRFD) $\Omega = 1.50$ (ASD)
	Limit State: Local Crippling of HSS Sidewalls, When $\beta = 1.0$ and Plate is in Compression, for T-Connections $R_n = 1.6 t^2 \left(1 + \frac{3l_b}{H - 3t} \right) \sqrt{E F_y} Q_f \quad (K1-10)$ $\phi = 0.75$ (LRFD) $\Omega = 2.00$ (ASD)
	Limit State: Local Crippling of HSS Sidewalls, When $\beta = 1.0$ and Plate is in Compression, for Cross-Connections $R_n = \left(\frac{48 t^3}{H - 3t} \right) \sqrt{E F_y} Q_f \quad (K1-11)$ $\phi = 0.90$ (LRFD) $\Omega = 1.67$ (ASD)

TABLE K1.2. (continued)
Available Strengths of
Plate-to-Rectangular HSS Connections

Connection Type	Connection Available Strength
<p>Longitudinal Plate T-, Y- and Cross-Connections, Under Plate Axial Load</p> 	<p>Limit State: HSS Plastification</p> $R_n \sin \theta = \frac{F_y t^2}{1 - \frac{t_p}{B}} \left(\frac{2l_b}{B} + 4 \sqrt{1 - \frac{t_p}{B}} Q_f \right) \quad (K1-12)$ <p>$\phi = 1.00$ (LRFD) $\Omega = 1.50$ (ASD)</p>
<p>Longitudinal Through Plate T- and Y-Connections, Under Plate Axial Load</p> 	<p>Limit State: HSS Wall Plastification</p> $R_n \sin \theta = \frac{2F_y t^2}{1 - \frac{t_p}{B}} \left(\frac{2l_b}{B} + 4 \sqrt{1 - \frac{t_p}{B}} Q_f \right) \quad (K1-13)$ <p>$\phi = 1.00$ (LRFD) $\Omega = 1.50$ (ASD)</p>
<p>Longitudinal Plate T-Connections, Under Plate Shear Load</p> 	<p>Limit States: Plate Limit States and HSS Punching Shear</p> <p>For R_n, see Chapter J. Additionally, the following relationship shall be met:</p> $t_p \leq \frac{F_u}{F_{yp}} t \quad (K1-3)$

TABLE K1.2 (continued)
Available Strengths of
Plate-to-Rectangular HSS Connections

Connection Type	Connection Available Strength
<p>Cap Plate Connections, under Axial Load</p> 	<p style="text-align: center;">Limit State: Local Yielding of Sidewalls</p> $R_n = 2F_y t (5t_p + l_b), \text{ when } (5t_p + l_b) < B \quad (\text{K1-14a})$ $R_n = F_y A, \text{ when } (5t_p + l_b) \geq B \quad (\text{K1-14b})$ <p style="text-align: center;">$\phi = 1.00$ (LRFD) $\Omega = 1.50$ (ASD)</p> <hr/> <p style="text-align: center;">Limit State: Local Crippling of Sidewalls, When Plate is in Compression</p> $R_n = 1.6t^2 \left[1 + \frac{6l_b}{B} \left(\frac{t}{t_p} \right)^{1.5} \right] \sqrt{EF_y \frac{t_p}{t}}, \text{ when } (5t_p + l_b) < B \quad (\text{K1-15})$ <p style="text-align: center;">$\phi = 0.75$ (LRFD) $\Omega = 2.00$ (ASD)</p>
FUNCTIONS	
<p>$Q_f = 1$ for HSS (connecting surface) in tension</p> $= 1.3 - 0.4 \frac{U}{\beta} \leq 1.0 \text{ for HSS (connecting surface) in compression, for transverse plate connections} \quad (\text{K1-16})$ $= \sqrt{1 - U^2} \text{ for HSS (connecting surface) in compression, for longitudinal plate and longitudinal through plate connections} \quad (\text{K1-17})$	
<p>$U = \left \frac{P_{ro}}{F_c A_g} + \frac{M_{ro}}{F_c S} \right$ where P_{ro} and M_{ro} are determined on the side of the joint that has the lower compression stress. P_{ro} and M_{ro} refer to required strengths in the HSS. (K1-6)</p> <p style="text-align: center;">$P_{ro} = P_u$ for LRFD; P_a for ASD. $M_{ro} = M_u$ for LRFD; M_a for ASD.</p>	
$B_{ep} = \frac{10B_p}{B/t} \leq B_p \quad (\text{K1-18})$	
<p>$k =$ outside corner radius of HSS $\geq 1.5 t$</p>	

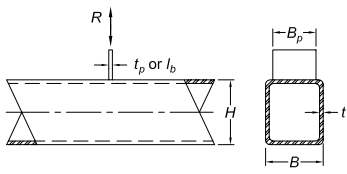
TABLE K1.2A
Limits of Applicability of Table K1.2

Plate load angle:	θ	$\geq 30^\circ$
HSS wall slenderness:	B/t or H/t	≤ 35 for loaded wall, for transverse branch plate connections
	B/t or H/t	≤ 40 for loaded wall, for longitudinal branch plate and through plate connections
	$(B-3t)/t$ or $(H-3t)/t$	$\leq 1.40\sqrt{E/F_y}$ for loaded wall, for branch plate shear loading
Width ratio:	$0.25 \leq B_p/B$	≤ 1.0 for transverse branch plate connections
Material strength:	F_y	≤ 52 ksi (360 MPa)
Ductility:	F_y/F_u	≤ 0.8 Note: ASTM A500 Grade C is acceptable.

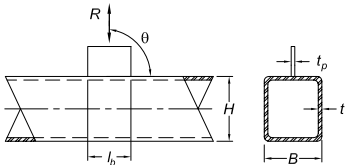
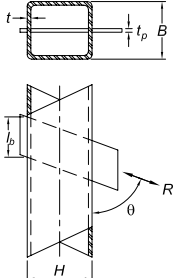
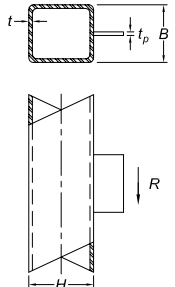
For the purposes of this Specification, the centerlines of branch members and chord members shall lie in a common plane. Rectangular HSS connections are further limited to have all members oriented with walls parallel to the plane. For trusses that are made with HSS that are connected by welding branch members to chord members, eccentricities within the limits of applicability are permitted without consideration of the resulting moments for the design of the connection.

1. Definitions of Parameters

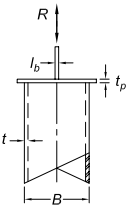
A_g = gross cross-sectional area of member, in.² (mm²)

B = overall width of rectangular *HSS main member*, measured 90° to the plane of the connection, in. (mm)

B_b = overall width of rectangular *HSS branch member*, measured 90° to the plane of the connection, in. (mm)

D = outside diameter of round HSS main member, in. (mm)

D_b = outside diameter of round HSS branch member, in. (mm)

F_c = *available stress* in chord, ksi (MPa)
= F_y for LRFD; $0.60F_y$ for ASD

F_y = *specified minimum yield stress* of HSS main member material, ksi (MPa)

F_{yb} = *specified minimum yield stress* of HSS branch member material, ksi (MPa)

F_u = *specified minimum tensile strength* of HSS material, ksi (MPa)

H = overall height of rectangular HSS main member, measured in the plane of the connection, in. (mm)

H_b = overall height of rectangular HSS branch member, measured in the plane of the connection, in. (mm)

O_v = $l_{ov}/l_p \times 100$, %

S = elastic section modulus of member, in.³ (mm³)

e = eccentricity in a truss connection, positive being away from the branches, in. (mm)

g = gap between toes of branch members in a gapped K-connection, neglecting the welds, in. (mm)

l_b = $H_b/\sin\theta$, in. (mm)

l_{ov} = overlap length measured along the connecting face of the chord beneath the two branches, in. (mm)

- l_p = projected length of the overlapping branch on the chord, in. (mm)
 t = *design wall thickness* of HSS main member, in. (mm)
 t_b = design wall thickness of HSS branch member, in. (mm)
 β = width ratio; the ratio of branch diameter to chord diameter = D_b/D for round HSS; the ratio of overall branch width to chord width = B_b/B for rectangular HSS
 β_{eff} = *effective width ratio*; the sum of the perimeters of the two branch members in a K-connection divided by eight times the chord width
 γ = chord slenderness ratio; the ratio of one-half the diameter to the wall thickness = $D/2t$ for round HSS; the ratio of one-half the width to wall thickness = $B/2t$ for rectangular HSS
 η = *load length parameter*, applicable only to rectangular HSS; the ratio of the length of contact of the branch with the chord in the plane of the connection to the chord width = l_b/B
 θ = acute angle between the branch and chord (degrees)
 ζ = gap ratio; the ratio of the gap between the branches of a gapped K-connection to the width of the chord = g/B for rectangular HSS

2. Round HSS

The *available strength* of HSS-to-HSS truss connections within the limits in Table K2.1A shall be taken as the lowest value of the applicable *limit states* shown in Table K2.1.

3. Rectangular HSS

The *available strength* of HSS-to-HSS truss connections within the limits in Table K2.2A shall be taken as the lowest value of the applicable *limit states* shown in Table K2.2.

K3. HSS-TO-HSS MOMENT CONNECTIONS

The *design strength*, ϕM_n , and the *allowable strength*, M_n/Ω , of *connections* shall be determined in accordance with the provisions of this chapter and the provisions of Section B3.6.

HSS-to-HSS moment connections are defined as connections that consist of one or two *branch members* that are directly welded to a continuous chord that passes through the connection, with the branch or branches loaded by bending moments.

A connection shall be classified as:

- (a) A *T-connection* when there is one branch and it is perpendicular to the chord and as a *Y-connection* when there is one branch but not perpendicular to the chord
- (b) A *cross-connection* when there is a branch on each (opposite) side of the chord

For the purposes of this Specification, the centerlines of the branch member(s) and the *chord member* shall lie in a common plane.

TABLE K2.1
Available Strengths of Round
HSS-to-HSS Truss Connections

Connection Type	Connection Available Axial Strength
<p>General Check For T-, Y-, Cross- and K-Connections With Gap, When $D_{b(tens/comp)} < (D - 2t)$</p>	<p>Limit State: Shear Yielding (Punching)</p> $P_n = 0.6F_y t \pi D_b \left(\frac{1 + \sin \theta}{2 \sin^2 \theta} \right) \quad (K2-1)$ <p>$\phi = 0.95$ (LRFD) $\Omega = 1.58$ (ASD)</p>
<p>T- and Y-Connections</p> 	<p>Limit State: Chord Plastification</p> $P_n \sin \theta = F_y t^2 (3.1 + 15.6 \beta^2) \gamma^{0.2} Q_f \quad (K2-2)$ <p>$\phi = 0.90$ (LRFD) $\Omega = 1.67$ (ASD)</p>
<p>Cross-Connections</p> 	<p>Limit State: Chord Plastification</p> $P_n \sin \theta = F_y t^2 \left(\frac{5.7}{1 - 0.8 \beta} \right) Q_f \quad (K2-3)$ <p>$\phi = 0.90$ (LRFD) $\Omega = 1.67$ (ASD)</p>
<p>K-Connections With Gap or Overlap</p> 	<p>Limit State: Chord Plastification</p> $(P_n \sin \theta)_{\text{compression branch}} = F_y t^2 \left(2.0 + 11.33 \frac{D_{b \text{ comp}}}{D} \right) Q_g Q_f \quad (K2-4)$ $(P_n \sin \theta)_{\text{tension branch}} = (P_n \sin \theta)_{\text{compression branch}} \quad (K2-5)$ <p>$\phi = 0.90$ (LRFD) $\Omega = 1.67$ (ASD)</p>

TABLE K2.1 (continued)
Available Strengths of Round
HSS-to-HSS Truss Connections

FUNCTIONS	
$Q_f = 1$ for chord (connecting surface) in tension	(K1-5a)
$= 1.0 - 0.3U(1 + U)$ for HSS (connecting surface) in compression	(K1-5b)
$U = \left \frac{P_{ro}}{F_c A_g} + \frac{M_{ro}}{F_c S} \right $ where P_{ro} and M_{ro} are determined on the side of the joint that has the lower compression stress. P_{ro} and M_{ro} refer to required strengths in the HSS.	(K1-6)
$P_{ro} = P_u$ for LRFD; P_a for ASD. $M_{ro} = M_u$ for LRFD; M_a for ASD.	
$Q_g = \gamma^{0.2} \left[1 + \frac{0.024\gamma^{1.2}}{\exp\left(\frac{0.5g}{t} - 1.33\right) + 1} \right]^{[a]}$	(K2-6)
^[a] Note that $\exp(x)$ is equal to e^x , where $e = 2.71828$ is the base of the natural logarithm.	

TABLE K2.1A
Limits of Applicability of Table K2.1

Joint eccentricity:	-0.55	$\leq e/D \leq 0.25$ for K-connections
Branch angle:	θ	$\geq 30^\circ$
Chord wall slenderness:	D/t	≤ 50 for T-, Y- and K-connections
	D/t	≤ 40 for cross-connections
Branch wall slenderness:	D_b/t_b	≤ 50 for tension branch
	D_b/t_b	$\leq 0.05E/F_{yb}$ for compression branch
Width ratio:	0.2	$< D_b/D \leq 1.0$ for T-, Y-, cross- and overlapped K-connections
	0.4	$\leq D_b/D \leq 1.0$ for gapped K-connections
Gap:	g	$\geq t_{b \text{ comp}} + t_{b \text{ tens}}$ for gapped K-connections
Overlap:	25%	$\leq O_v \leq 100\%$ for overlapped K-connections
Branch thickness:	t_b overlapping	$\leq t_{b \text{ overlapped}}$ for branches in overlapped K-connections
Material strength:	F_y and F_{yb}	≤ 52 ksi (360 MPa)
Ductility:	F_y/F_u and F_{yb}/F_{ub}	≤ 0.8 Note: ASTM A500 Grade C is acceptable.

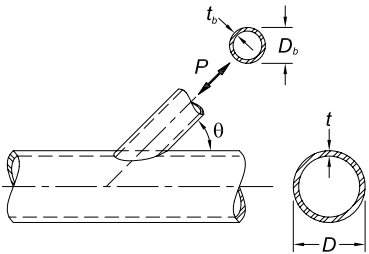
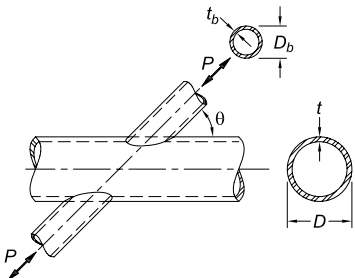
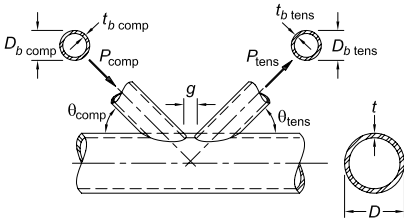
TABLE K2.2
Available Strengths of Rectangular
HSS-to-HSS Truss Connections

Connection Type	Connection Available Axial Strength
<p>T-, Y- and Cross-Connections</p> 	<p>Limit State: Chord Wall Plastification, When $\beta \leq 0.85$</p> $P_n \sin \theta = F_y t^2 \left[\frac{2\eta}{(1-\beta)} + \frac{4}{\sqrt{1-\beta}} \right] Q_f \quad (K2-7)$ <p>$\phi = 1.00$ (LRFD) $\Omega = 1.50$ (ASD)</p> <p>Limit State: Shear Yielding (Punching), When $0.85 < \beta \leq 1 - 1/\gamma$ or $B/t < 10$</p> $P_n \sin \theta = 0.6 F_y t B (2\eta + 2\beta_{eop}) \quad (K2-8)$ <p>$\phi = 0.95$ (LRFD) $\Omega = 1.58$ (ASD)</p> <p>Limit State: Local Yielding of Chord Sidewalls, When $\beta = 1.0$</p> $P_n \sin \theta = 2 F_y t (5k + l_b) \quad (K2-9)$ <p>$\phi = 1.00$ (LRFD) $\Omega = 1.50$ (ASD)</p>
<p>Case for checking limit state of shear of chord side walls</p> 	<p>Limit State: Local Crippling of Chord Sidewalls, When $\beta = 1.0$ and Branch is in Compression, for T- or Y-Connections</p> $P_n \sin \theta = 1.6 t^2 \left(1 + \frac{3l_b}{H - 3t} \right) \sqrt{E F_y} Q_f \quad (K2-10)$ <p>$\phi = 0.75$ (LRFD) $\Omega = 2.00$ (ASD)</p> <p>Limit State: Local Crippling of Chord Sidewalls, When $\beta = 1.0$ and Branches are in Compression, for Cross-Connections</p> $P_n \sin \theta = \left(\frac{48 t^3}{H - 3t} \right) \sqrt{E F_y} Q_f \quad (K2-11)$ <p>$\phi = 0.90$ (LRFD) $\Omega = 1.67$ (ASD)</p>
	<p>Limit State: Local Yielding of Branch/Branches Due to Uneven Load Distribution, When $\beta > 0.85$</p> $P_n = F_{yb} t_b (2H_b + 2b_{eoi} - 4t_b) \quad (K2-12)$ <p>$\phi = 0.95$ (LRFD) $\Omega = 1.58$ (ASD)</p> <p>where</p> $b_{eoi} = \frac{10}{B/t} \left(\frac{F_y t}{F_{yb} t_b} \right) B_b \leq B_b \quad (K2-13)$

TABLE K2.2 (continued)
Available Strengths of Rectangular
HSS-to-HSS Truss Connections

Connection Type	Connection Available Axial Strength
T-, Y- and Cross-Connections	Limit State: Shear of Chord Sidewalls For Cross-Connections With $\theta < 90^\circ$ and Where a Projected Gap is Created (See Figure). Determine $P_n \sin \theta$ in accordance with Section G5.
<p>Gapped K-Connections</p> 	<p>Limit State: Chord Wall Plastification, for All β</p> $P_n \sin \theta = F_y t^2 (9.8 \beta_{eff} \gamma^{0.5}) Q_f \quad (K2-14)$ <p>$\phi = 0.90$ (LRFD) $\Omega = 1.67$ (ASD)</p> <p>Limit State: Shear Yielding (Punching), when $B_b < B - 2t$ Do not check for square branches.</p> $P_n \sin \theta = 0.6 F_y t B (2\eta + \beta + \beta_{eop}) \quad (K2-15)$ <p>$\phi = 0.95$ (LRFD) $\Omega = 1.58$ (ASD)</p> <p>Limit State: Shear of Chord Sidewalls, in the Gap Region Determine $P_n \sin \theta$ in accordance with Section G5. Do not check for square chords.</p> <p>Limit State: Local Yielding of Branch/Branches Due to Uneven Load Distribution. Do not check for square branches or if $B/t \geq 15$.</p> $P_n = F_{yb} t_b (2H_b + B_b + b_{eoi} - 4t_b) \quad (K2-16)$ <p>$\phi = 0.95$ (LRFD) $\Omega = 1.58$ (ASD)</p> <p>where</p> $b_{eoi} = \frac{10}{B/t} \left(\frac{F_y t}{F_{yb} t_b} \right) B_b \leq B_b \quad (K2-13)$

TABLE K2.2 (continued)
Available Strengths of Rectangular
HSS-to-HSS Truss Connections

Connection Type	Connection Available Axial Strength
<p style="text-align: center;">Overlapped K-Connections</p>  <p>Note that the force arrows shown for overlapped K-connections may be reversed; <i>i</i> and <i>j</i> control member identification.</p>	<p>Limit State: Local Yielding of Branch/Branches Due to Uneven Load Distribution</p> <p style="text-align: center;">$\phi = 0.95$ (LRFD) $\Omega = 1.58$ (ASD)</p> <p>When $25\% \leq O_v < 50\%$:</p> $P_{n,i} = F_{ybi} t_{bi} \left[\frac{O_v}{50} (2H_{bi} - 4t_{bi}) + b_{eoi} + b_{eov} \right] \quad (K2-17)$ <p>When $50\% \leq O_v < 80\%$:</p> $P_{n,i} = F_{ybi} t_{bi} (2H_{bi} - 4t_{bi} + b_{eoi} + b_{eov}) \quad (K2-18)$ <p>When $80\% \leq O_v < 100\%$:</p> $P_{n,i} = F_{ybi} t_{bi} (2H_{bi} - 4t_{bi} + B_{bi} + b_{eov}) \quad (K2-19)$ $b_{eoi} = \frac{10}{B/t} \left(\frac{F_y t}{F_{ybi} t_{bi}} \right) B_{bi} \leq B_{bi} \quad (K2-20)$ $b_{eov} = \frac{10}{B_{bj}/t_{bj}} \left(\frac{F_{ybj} t_{bj}}{F_{ybi} t_{bi}} \right) B_{bi} \leq B_{bi} \quad (K2-21)$ <p>Subscript <i>i</i> refers to the overlapping branch Subscript <i>j</i> refers to the overlapped branch</p> $P_{n,j} = P_{n,i} \left(\frac{F_{ybj} A_{bj}}{F_{ybi} A_{bi}} \right) \quad (K2-22)$
FUNCTIONS	
$Q_f = 1$ for chord (connecting surface) in tension (K1-5a)	
$= 1.3 - 0.4 \frac{U}{\beta} \leq 1$ for chord (connecting surface) in compression, for T-, Y- and cross-connections (K1-16)	
$= 1.3 - 0.4 \frac{U}{\beta_{eff}} \leq 1.0$ for chord (connecting surface) in compression, for gapped K-connections (K2-23)	
$U = \left \frac{P_{ro}}{F_c A_g} + \frac{M_{ro}}{F_c S} \right $ where P_{ro} and M_{ro} are determined on the side of the joint that has the higher compression stress. P_{ro} and M_{ro} refer to required strengths in the HSS. (K1-6)	
$P_{ro} = P_u$ for LRFD; P_a for ASD. $M_{ro} = M_u$ for LRFD; M_a for ASD.	
$\beta_{eff} = \left[(B_b + H_b)_{\text{compression branch}} + (B_b + H_b)_{\text{tension branch}} \right] / 4B$ (K2-24)	
$\beta_{exp} = \frac{5\beta}{\gamma} \leq \beta$ (K2-25)	

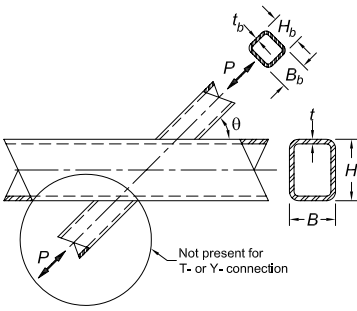
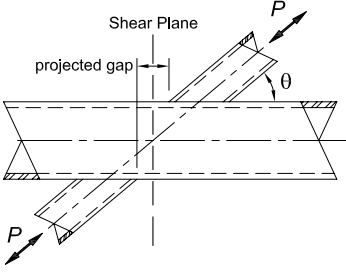
TABLE K2.2A
Limits of Applicability of Table K2.2

Joint eccentricity:	-0.55	$\leq e/H \leq 0.25$ for K-connections
Branch angle:	θ	$\geq 30^\circ$
Chord wall slenderness:	B/t and H/t	≤ 35 for gapped K-connections and T-, Y- and cross-connections
	B/t	≤ 30 for overlapped K-connections
	H/t	≤ 35 for overlapped K-connections
Branch wall slenderness:	B_b/t_b and H_b/t_b	≤ 35 for tension branch
		$\leq 1.25 \sqrt{\frac{E}{F_{yb}}}$ for compression branch of gapped K-, T-, Y- and cross-connections
		≤ 35 for compression branch of gapped K-, T-, Y- and cross-connections
		$\leq 1.1 \sqrt{\frac{E}{F_{yb}}}$ for compression branch of overlapped K-connections
Width ratio:	B_b/B and H_b/B	≥ 0.25 for T-, Y- cross- and overlapped K-connections
Aspect ratio:	0.5	$\leq H_b/B_b \leq 2.0$ and $0.5 \leq H/B \leq 2.0$
Overlap:	25%	$\leq O_v \leq 100\%$ for overlapped K-connections
Branch width ratio:	B_{bi}/B_{bj}	≥ 0.75 for overlapped K-connections, where subscript i refers to the overlapping branch and subscript j refers to the overlapped branch
Branch thickness ratio:	t_{bi}/t_{bj}	≤ 1.0 for overlapped K-connections, where subscript i refers to the overlapping branch and subscript j refers to the overlapped branch
Material strength:	F_y and F_{yb}	≤ 52 ksi (360 MPa)
Ductility:	F_y/F_u and F_{yb}/F_{ub}	≤ 0.8 Note: ASTM A500 Grade C is acceptable.
ADDITIONAL LIMITS FOR GAPPED K-CONNECTIONS		
Width ratio:	$\frac{B_b}{B}$ and $\frac{H_b}{B}$	$\geq 0.1 + \frac{\gamma}{50}$
	β_{eff}	≥ 0.35
Gap ratio:	$\zeta = g/B$	$\geq 0.5 (1 - \beta_{eff})$
Gap:	g	$\geq t_b$ compression branch + t_b tension branch
Branch size:	smaller B_b	≥ 0.63 (larger B_b), if both branches are square
Note: Maximum gap size will be controlled by the e/H limit. If gap is large, treat as two Y-connections.		

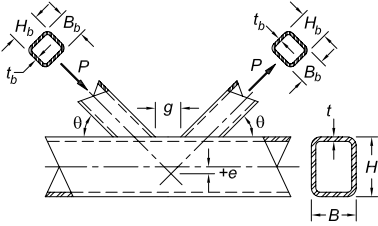
1. Definitions of Parameters

A_g = gross cross-sectional area of member, in.² (mm²)

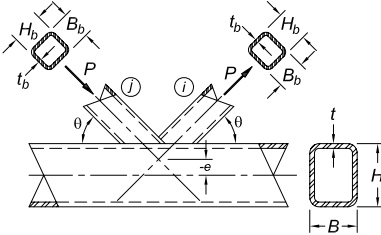
B = overall width of rectangular *HSS main member*, measured 90 ° to the plane of the connection, in. (mm)

B_b = overall width of rectangular *HSS branch member*, measured 90 ° to the plane of the connection, in. (mm)

D = outside diameter of round HSS main member, in. (mm)

D_b = outside diameter of round HSS branch member, in. (mm)

F_c = *available stress*, ksi (MPa)
= F_y for LRFD; 0.60 F_y for ASD

F_y = *specified minimum yield stress* of HSS main member material, ksi (MPa)

F_{yb} = *specified minimum yield stress* of HSS branch member material, ksi (MPa)

F_u = *specified minimum tensile strength* of HSS member material, ksi (MPa)

H = overall height of rectangular HSS main member, measured in the plane of the connection, in. (mm)

H_b = overall height of rectangular HSS branch member, measured in the plane of the connection, in. (mm)

S = elastic section modulus of member, in.³ (mm³)

Z_b = Plastic section modulus of branch about the axis of bending, in.³ (mm³)

t = *design wall thickness* of HSS main member, in. (mm)

t_b = design wall thickness of HSS branch member, in. (mm)

β = width ratio

= D_b/D for round HSS; ratio of branch diameter to chord diameter

= B_b/B for rectangular HSS; ratio of overall branch width to chord width

γ = chord slenderness ratio

= $D/2t$ for round HSS; ratio of one-half the diameter to the wall thickness

= $B/2t$ for rectangular HSS; ratio of one-half the width to the wall thickness

η = *load length parameter*, applicable only to rectangular HSS

= l_b/B ; the ratio of the length of contact of the branch with the chord in the plane of the connection to the chord width, where $l_b = H_b / \sin \theta$

θ = acute angle between the branch and chord (degrees)

2. Round HSS

The *available strength* of moment connections within the limits of Table K3.1A shall be taken as the lowest value of the applicable *limit states* shown in Table K3.1.

3. Rectangular HSS

The *available strength* of moment connections within the limits of Table K3.2A shall be taken as the lowest value of the applicable *limit states* shown in Table K3.2.

K4. WELDS OF PLATES AND BRANCHES TO RECTANGULAR HSS

The *design strength*, ϕR_n , ϕM_n and ϕP_n , and the *allowable strength*, R_n/Ω , M_n/Ω and P_n/Ω , of *connections* shall be determined in accordance with the provisions of this chapter and the provisions of Section B3.6.

TABLE K3.1
Available Strengths of Round
HSS-to-HSS Moment Connections

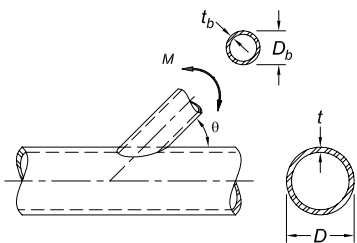
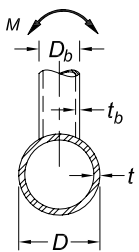
Connection Type	Connection Available Flexural Strength
Branch(es) under In-Plane Bending T-, Y- and Cross-Connections 	Limit State: Chord Plastification $M_n \sin \theta = 5.39 F_y t^2 \gamma^{0.5} \beta D_b Q_f \quad (\text{K3-1})$ $\phi = 0.90 \text{ (LRFD)} \quad \Omega = 1.67 \text{ (ASD)}$
	Limit State: Shear Yielding (Punching), When $D_b < (D - 2t)$ $M_n = 0.6 F_y t D_b^2 \left(\frac{1 + 3 \sin \theta}{4 \sin^2 \theta} \right) \quad (\text{K3-2})$ $\phi = 0.95 \text{ (LRFD)} \quad \Omega = 1.58 \text{ (ASD)}$
Branch(es) under Out-of-Plane Bending T-, Y- and Cross-Connections 	Limit State: Chord Plastification $M_n \sin \theta = F_y t^2 D_b^2 \left(\frac{3.0}{1 - 0.81 \beta} \right) Q_f \quad (\text{K3-3})$ $\phi = 0.90 \text{ (LRFD)} \quad \Omega = 1.67 \text{ (ASD)}$
	Limit State: Shear Yielding (Punching), When $D_b < (D - 2t)$ $M_n = 0.6 F_y t D_b^2 \left(\frac{3 + \sin \theta}{4 \sin^2 \theta} \right) \quad (\text{K3-4})$ $\phi = 0.95 \text{ (LRFD)} \quad \Omega = 1.58 \text{ (ASD)}$

For T-, Y- and cross-connections, with branch(es) under combined axial load, in-plane bending and out-of-plane bending, or any combination of these load effects:

$$\frac{P_r}{P_c} + \left(\frac{M_{r-ip}}{M_{c-ip}} \right)^2 + \left(\frac{M_{r-op}}{M_{c-op}} \right)^2 \leq 1.0 \quad (\text{K3-5})$$

$M_{c-ip} = \phi M_n$ = design flexural strength for in-plane bending from Table K3.1, kip-in. (N-mm)

= M_n / Ω = allowable flexural strength for in-plane bending from Table K3.1, kip-in. (N-mm)

$M_{c-op} = \phi M_n$ = design flexural strength for out-of-plane bending from Table K3.1, kip-in. (N-mm)

= M_n / Ω = allowable flexural strength for out-of-plane bending from Table K3.1, kip-in. (N-mm)

M_{r-ip} = required flexural strength for in-plane bending, using LRFD or ASD load combinations, as applicable, kip-in. (N-mm)

M_{r-op} = required flexural strength for out-of-plane bending, using LRFD or ASD load combinations, as applicable, kip-in. (N-mm)

$P_c = \phi P_n$ = design axial strength from Table K2.1, kips (N)

= P_n / Ω = allowable axial strength from Table K2.1, kips (N)

P_r = required axial strength using LRFD or ASD load combinations, as applicable, kips (N)

TABLE K3.1 (continued) Available Strengths of Round HSS-to-HSS Moment Connections

FUNCTIONS

$Q_f = 1$ for chord (connecting surface) in tension

$$= 1.0 - 0.3U(1 + U) \text{ for HSS (connecting surface) in compression} \quad (\text{K1-5})$$

$$U = \left[\frac{P_{ro}}{F_c A_g} + \frac{M_{ro}}{F_c S} \right], \text{ where } P_{ro} \text{ and } M_{ro} \text{ are determined on the side of the joint that has the lower compression stress. } P_{ro} \text{ and } M_{ro} \text{ refer to required strengths in the HSS.} \quad (\text{K1-6})$$

$P_{ro} = P_u$ for LRFD; P_a for ASD. $M_{ro} = M_u$ for LRFD; M_a for ASD.

TABLE K3.1A Limits of Applicability of Table K3.1

Branch angle:	θ	$\geq 30^\circ$
Chord wall slenderness:	D/t	≤ 50 for T- and Y-connections
	D/t	≤ 40 for cross-connections
Branch wall slenderness:	D_b/t_b	≤ 50
	D_b/t_b	$\leq 0.05E/F_{yb}$
Width ratio:	0.2	$< D_b/D \leq 1.0$
Material strength:	F_y and F_{yb}	≤ 52 ksi (360 MPa)
Ductility:	F_y/F_u and F_{yb}/F_{ub}	≤ 0.8 Note: ASTM A500 Grade C is acceptable.

TABLE K3.2
Available Strengths of Rectangular
HSS-to-HSS Moment Connections

Connection Type	Connection Available Flexural Strength
<p>Branch(es) under In-Plane Bending T- and Cross-Connections</p> 	<p>Limit State: Chord Wall Plastification, When $\beta \leq 0.85$</p> $M_n = F_y t^2 H_b \left[\frac{1}{2\eta} + \frac{2}{\sqrt{1-\beta}} + \frac{\eta}{(1-\beta)} \right] Q_f \quad (K3-6)$ <p>$\phi = 1.00$ (LRFD) $\Omega = 1.50$ (ASD)</p> <p>Limit State: Sidewall Local Yielding, When $\beta > 0.85$</p> $M_n = 0.5 F_y^* t (H_b + 5t)^2 \quad (K3-7)$ <p>$\phi = 1.00$ (LRFD) $\Omega = 1.50$ (ASD)</p> <p>Limit State: Local Yielding of Branch/Branches Due to Uneven Load Distribution, When $\beta > 0.85$</p> $M_n = F_{yb} \left[Z_b - \left(1 - \frac{b_{eol}}{B_b} \right) B_b H_b t_b \right] \quad (K3-8)$ <p>$\phi = 0.95$ (LRFD) $\Omega = 1.58$ (ASD)</p>
<p>Branch(es) under Out-of-Plane Bending T- and Cross-Connections</p> 	<p>Limit State: Chord Wall Plastification, When $\beta \leq 0.85$</p> $M_n = F_y t^2 \left[\frac{0.5 H_b (1+\beta)}{(1-\beta)} + \sqrt{\frac{2 B B_b (1+\beta)}{(1-\beta)}} \right] Q_f \quad (K3-9)$ <p>$\phi = 1.00$ (LRFD) $\Omega = 1.50$ (ASD)</p> <p>Limit State: Sidewall Local Yielding, When $\beta > 0.85$</p> $M_n = F_y^* t (B - t) (H_b + 5t) \quad (K3-10)$ <p>$\phi = 1.00$ (LRFD) $\Omega = 1.50$ (ASD)</p> <p>Limit State: Local Yielding of Branch/Branches Due to Uneven Load Distribution, When $\beta > 0.85$</p> $M_n = F_{yb} \left[Z_b - 0.5 \left(1 - \frac{b_{eol}}{B_b} \right)^2 B_b^2 t_b \right] \quad (K3-11)$ <p>$\phi = 0.95$ (LRFD) $\Omega = 1.58$ (ASD)</p>

TABLE K3.2 (continued)
Available Strengths of Rectangular
HSS-to-HSS Moment Connections

Connection Type	Connection Available Flexural Strength
Branch(es) under Out-of-Plane Bending T- and Cross-Connections (continued)	Limit State: Chord Distortional Failure, for T-Connections and Unbalanced Cross-Connections $M_n = 2F_y t \left[H_b t + \sqrt{BHt(B+H)} \right] \quad (K3-12)$ $\phi = 1.00 \text{ (LRFD)} \quad \Omega = 1.50 \text{ (ASD)}$
For T- and cross-connections, with branch(es) under combined axial load, in-plane bending and out-of-plane bending, or any combination of these load effects: $\frac{P_r}{P_c} + \left(\frac{M_{r-ip}}{M_{c-ip}} \right) + \left(\frac{M_{r-op}}{M_{c-op}} \right) \leq 1.0 \quad (K3-13)$ <p> $M_{c-ip} = \phi M_n$ = design flexural strength for in-plane bending from Table K3.2, kip-in. (N-mm) $= M_n / \Omega$ = allowable flexural strength for in-plane bending from Table K3.2, kip-in. (N-mm) $M_{c-op} = \phi M_n$ = design flexural strength for out-of-plane bending from Table K3.2, kip-in. (N-mm) $= M_n / \Omega$ = allowable flexural strength for out-of-plane bending from Table K3.2, kip-in. (N-mm) M_{r-ip} = required flexural strength for in-plane bending, using LRFD or ASD load combinations, as applicable, kip-in. (N-mm) M_{r-op} = required flexural strength for out-of-plane bending, using LRFD or ASD load combinations, as applicable, kip-in. (N-mm) $P_c = \phi P_n$ = design axial strength from Table K2.2, kips (N) $= P_n / \Omega$ = allowable axial strength from Table K2.2, kips (N) P_r = required axial strength using LRFD or ASD load combinations, as applicable, kips (N) </p>	
FUNCTIONS	
$Q_f = 1$ for chord (connecting surface) in tension (K1-15) $= 1.3 - 0.4 \frac{U}{\beta} \leq 1.0$ for chord (connecting surface) in compression (K1-16)	
$U = \left[\frac{P_{ro}}{F_c A_g} + \frac{M_{ro}}{F_c S} \right]$ <p style="text-align: center;"> where P_{ro} and M_{ro} are determined on the side of the joint that has the lower compression stress. P_{ro} and M_{ro} refer to required strengths in the HSS. $P_{ro} = P_u$ for LRFD; P_a for ASD. $M_{ro} = M_u$ for LRFD; M_a for ASD. </p>	
$F_y^* = F_y$ for T-connections and $= 0.8F_y$ for cross-connections	
$b_{eol} = \frac{10}{B/t} \left(\frac{F_y t}{F_{yb} t_b} \right) B_b \leq B_b \quad (K2-13)$	

TABLE K3.2A
Limits of Applicability of Table K3.2

Branch angle:	θ	$\cong 90^\circ$
Chord wall slenderness:	B/t and H/t	≤ 35
Branch wall slenderness:	B_b/t_b and H_b/t_b	≤ 35
		$\leq 1.25 \sqrt{\frac{E}{F_{yb}}}$
Width ratio:	B_b/B	≥ 0.25
Aspect ratio:	0.5	$\leq H_b/B_b \leq 2.0$ and $0.5 \leq H/B \leq 2.0$
Material strength:	F_y and F_{yb}	≤ 52 ksi (360 MPa)
Ductility:	F_y/F_u and F_{yb}/F_{ub}	≤ 0.8 Note: ASTM A500 Grade C is acceptable.

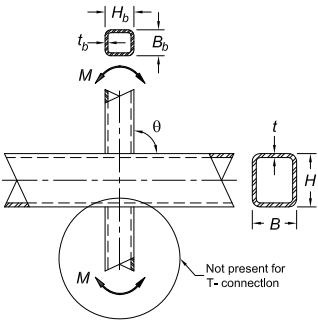
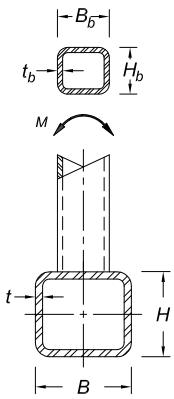
The available strength of branch connections shall be determined for the limit state of nonuniformity of load transfer along the line of weld, due to differences in relative *stiffness* of HSS walls in HSS-to-HSS connections and between elements in transverse plate-to-HSS connections, as follows:

$$R_n \text{ or } P_n = F_{nw} t_w l_e \quad (\text{K4-1})$$

$$M_{n-ip} = F_{nw} S_{ip} \quad (\text{K4-2})$$

$$M_{n-op} = F_{nw} S_{op} \quad (\text{K4-3})$$

For interaction, see Equation K3-13.

(a) For *fillet welds*

$$\phi = 0.75 \text{ (LRFD)} \quad \Omega = 2.00 \text{ (ASD)}$$

(b) For *partial-joint-penetration groove welds*

$$\phi = 0.80 \text{ (LRFD)} \quad \Omega = 1.88 \text{ (ASD)}$$

where

F_{nw} = nominal *stress* of *weld metal* (Chapter J) with no increase in strength due to directionality of load, ksi (MPa)

S_{ip} = effective elastic section modulus of welds for in-plane bending (Table K4.1), in.³ (mm³)

S_{op} = effective elastic section modulus of welds for out-of-plane bending (Table K4.1), in.³ (mm³)

l_e = total effective weld length of groove and fillet welds to rectangular HSS for weld strength calculations, in. (mm)

t_w = smallest effective weld throat around the perimeter of branch or plate, in. (mm)

TABLE K4.1
Effective Weld Properties for
Connections to Rectangular HSS

Connection Type	Connection Weld Strength
<p>Transverse Plate T- and Cross-Connections Under Plate Axial Load</p> 	<p>Effective Weld Properties</p> $l_e = 2 \left(\frac{10}{B/t} \right) \left(\frac{F_y t}{F_{yp} t_p} \right) B_p \leq 2B_p \quad (K4-4)$ <p>where l_e = total effective weld length for welds on both sides of the transverse plate</p>
<p>T-, Y- and Cross-Connections Under Branch Axial Load or Bending</p>  <p>Section A-A</p> <p>Effective Weld</p>	<p>Effective Weld Properties</p> $l_e = \frac{2H_b}{\sin\theta} + 2b_{eoi} \quad (K4-5)$ $S_{ip} = \frac{t_w}{3} \left(\frac{H_b}{\sin\theta} \right)^2 + t_w b_{eoi} \left(\frac{H_b}{\sin\theta} \right) \quad (K4-6)$ $S_{op} = t_w \left(\frac{H_b}{\sin\theta} \right) B_b + \frac{t_w}{3} (B_b^2) - \frac{(t_w/3)(B_b - b_{eoi})^3}{B_b} \quad (K4-7)$ $b_{eoi} = \frac{10}{B/t} \left(\frac{F_y t}{F_{yb} t_b} \right) B_b \leq B_b \quad (K2-13)$ <p>When $\beta > 0.85$ or $\theta > 50^\circ$, $b_{eoi}/2$ shall not exceed $2t$.</p>
<p>Gapped K-Connections Under Branch Axial Load</p>  <p>Section A-A</p> <p>Effective Weld: $\theta \geq 60^\circ$ 4th side effective when $\theta \leq 50^\circ$</p>	<p>Effective Weld Properties</p> <p>When $\theta \leq 50^\circ$:</p> $l_e = \frac{2(H_b - 1.2t_b)}{\sin\theta} + 2(B_b - 1.2t_b) \quad (K4-8)$ <p>When $\theta \geq 60^\circ$:</p> $l_e = \frac{2(H_b - 1.2t_b)}{\sin\theta} + (B_b - 1.2t_b) \quad (K4-9)$ <p>When $50^\circ < \theta < 60^\circ$, linear interpolation shall be used to determine l_e.</p>

TABLE K4.1 (continued)
Effective Weld Properties for
Connections to Rectangular HSS

Connection Type	Connection Weld Strength
<p data-bbox="177 355 441 407">Overlapped K-Connections under Branch Axial Load</p>  <p data-bbox="132 720 487 833">Note that the force arrows shown for overlapped K-connections may be reversed; <i>i</i> and <i>j</i> control member identification</p> <p data-bbox="120 868 223 894">Section A-A</p>  <p data-bbox="241 1050 453 1085">Effective Weld: Eq. K4-13</p> <p data-bbox="189 1085 424 1137">When $\frac{B_{bj}}{B} \leq 0.85$ and $\theta_j \leq 50^\circ$</p>  <p data-bbox="241 1345 367 1380">Effective Weld:</p> <p data-bbox="189 1380 413 1432">When $\frac{B_{bj}}{B} > 0.85$ or $\theta_j > 50^\circ$</p>	<p data-bbox="545 355 1004 407">Overlapping Member Effective Weld Properties (all dimensions are for the overlapping branch, <i>i</i>)</p> <p data-bbox="522 434 751 460">When $25\% \leq O_v < 50\%$:</p> $l_{e,i} = \frac{2O_v}{50} \left[\left(1 - \frac{O_v}{100} \right) \left(\frac{H_{bj}}{\sin\theta_i} \right) + \frac{O_v}{100} \left(\frac{H_{bj}}{\sin(\theta_i + \theta_j)} \right) \right] + b_{eoi} + b_{eov} \quad (K4-10)$ <p data-bbox="522 616 751 642">When $50\% \leq O_v < 80\%$:</p> $l_{e,i} = 2 \left[\left(1 - \frac{O_v}{100} \right) \left(\frac{H_{bj}}{\sin\theta_i} \right) + \frac{O_v}{100} \left(\frac{H_{bj}}{\sin(\theta_i + \theta_j)} \right) \right] + b_{eoi} + b_{eov} \quad (K4-11)$ <p data-bbox="522 798 763 824">When $80\% \leq O_v \leq 100\%$:</p> $l_{e,i} = 2 \left[\left(1 - \frac{O_v}{100} \right) \left(\frac{H_{bj}}{\sin\theta_i} \right) + \frac{O_v}{100} \left(\frac{H_{bj}}{\sin(\theta_i + \theta_j)} \right) \right] + B_{bj} + b_{eov} \quad (K4-12)$ $b_{eoi} = \frac{10}{B/t} \left(\frac{F_y t}{F_{yb} t_{bj}} \right) B_{bi} \leq B_{bi} \quad (K2-20)$ $b_{eov} = \frac{10}{B_{bj}/t_{bj}} \left(\frac{F_y t_{bj}}{F_{yb} t_{bi}} \right) B_{bi} \leq B_{bi} \quad (K2-21)$ <p data-bbox="533 1189 1015 1275">when $B_{bi}/B_b > 0.85$ or $\theta_i > 50^\circ$, $b_{eoi}/2$ shall not exceed $2t$ and when $B_{bi}/B_b > 0.85$ or $(180 - \theta_i - \theta_j) > 50^\circ$, $b_{eov}/2$ shall not exceed $2t_{bj}$</p> <p data-bbox="568 1293 981 1345">Subscript <i>i</i> refers to the overlapping branch Subscript <i>j</i> refers to the overlapped branch</p> $l_{e,j} = \frac{2H_{bj}}{\sin\theta_j} + 2b_{eoj} \quad (K4-13)$ $b_{eoj} = \frac{10}{B/t} \left(\frac{F_y t}{F_{yb} t_{bj}} \right) B_{bj} \leq B_{bj} \quad (K4-14)$ <p data-bbox="522 1553 815 1588">When $B_{bj}/B > 0.85$ or $\theta_j > 50^\circ$,</p> $l_{e,j} = 2 (H_{bj} - 1.2t_{bj}) / \sin\theta_j$

When an overlapped K-connection has been designed in accordance with Table K2.2 of this chapter, and the *branch member* component forces normal to the chord are 80% “balanced” (i.e., the branch member forces normal to the chord face differ by no more than 20%), the “hidden” weld under an overlapping branch may be omitted if the remaining welds to the overlapped branch everywhere develop the full capacity of the overlapped branch member walls.

The weld checks in Table K4.1 are not required if the welds are capable of developing the full strength of the branch member wall along its entire perimeter (or a plate along its entire length).

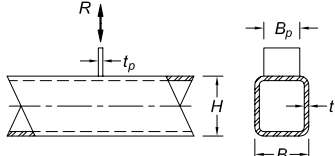
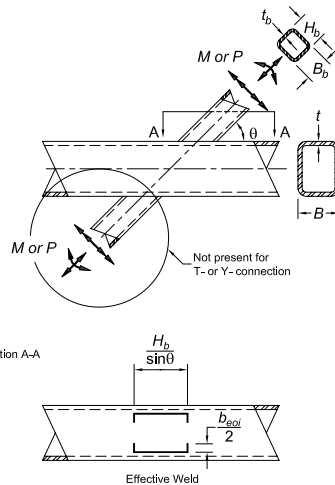
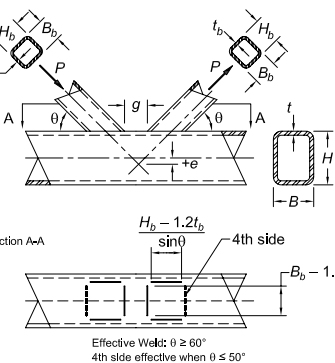
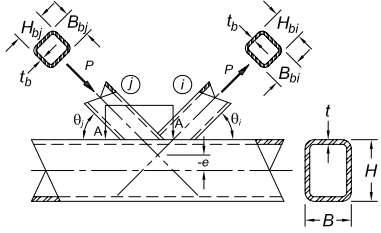
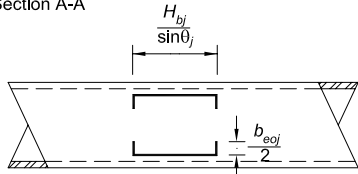
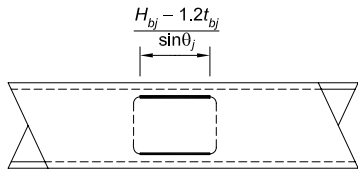
User Note: The approach used here to allow down-sizing of welds assumes a constant weld size around the full perimeter of the HSS branch. Special attention is required for equal width (or near-equal width) connections which combine partial-joint-penetration groove welds along the matched edges of the connection, with fillet welds generally across the *main member* face.

CHAPTER L

DESIGN FOR SERVICEABILITY

This chapter addresses serviceability design requirements.

The chapter is organized as follows:

- L1. General Provisions
- L2. Camber
- L3. Deflections
- L4. Drift
- L5. Vibration
- L6. Wind-Induced Motion
- L7. Expansion and Contraction
- L8. Connection Slip

L1. GENERAL PROVISIONS

Serviceability is a state in which the function of a building, its appearance, maintainability, durability and comfort of its occupants are preserved under normal usage. Limiting values of structural behavior for serviceability (such as maximum deflections and accelerations) shall be chosen with due regard to the intended function of the structure. Serviceability shall be evaluated using appropriate *load combinations* for the *serviceability limit states* identified.

User Note: Serviceability limit states, *service loads*, and appropriate *load combinations* for *serviceability* requirements can be found in ASCE/SEI 7, Appendix C and Commentary to Appendix C. The performance requirements for serviceability in this chapter are consistent with those requirements. Service loads, as stipulated herein, are those that act on the structure at an arbitrary point in time and are not usually taken as the *nominal loads*.

L2. CAMBER

Where *camber* is used to achieve proper position and location of the structure, the magnitude, direction and location of camber shall be specified in the structural drawings.

L3. DEFLECTIONS

Deflections in structural members and *structural systems* under appropriate *service load combinations* shall not impair the *serviceability* of the structure.

User Note: Conditions to be considered include levelness of floors, alignment of structural members, integrity of building finishes, and other factors that affect the normal usage and function of the structure. For *composite* members, the additional deflections due to the shrinkage and creep of the concrete should be considered.

L4. DRIFT

Drift of a structure shall be evaluated under *service loads* to provide for *serviceability* of the structure, including the integrity of interior partitions and exterior *cladding*. Drift under strength *load combinations* shall not cause collision with adjacent structures or exceed the limiting values of such drifts that may be specified by the *applicable building code*.

L5. VIBRATION

The effect of vibration on the comfort of the occupants and the function of the structure shall be considered. The sources of vibration to be considered include pedestrian loading, vibrating machinery and others identified for the structure.

L6. WIND-INDUCED MOTION

The effect of wind-induced motion of buildings on the comfort of occupants shall be considered.

L7. EXPANSION AND CONTRACTION

The effects of thermal expansion and contraction of a building shall be considered. Damage to building *cladding* can cause water penetration and may lead to corrosion.

L8. CONNECTION SLIP

The effects of *connection slip* shall be included in the design where slip at bolted connections may cause deformations that impair the *serviceability* of the structure. Where appropriate, the connection shall be designed to preclude slip.

User Note: For the design of *slip-critical connections*, see Sections J3.8 and J3.9. For more information on connection slip, refer to the RCSC *Specification for Structural Joints Using High-Strength Bolts*.

CHAPTER M

FABRICATION AND ERECTION

This chapter addresses requirements for shop drawings, fabrication, shop painting and erection.

The chapter is organized as follows:

- M1. Shop and Erection Drawings
- M2. Fabrication
- M3. Shop Painting
- M4. Erection

M1. SHOP AND ERECTION DRAWINGS

Shop and erection drawings are permitted to be prepared in stages. Shop drawings shall be prepared in advance of fabrication and give complete information necessary for the fabrication of the component parts of the structure, including the location, type and size of welds and bolts. Erection drawings shall be prepared in advance of erection and give information necessary for erection of the structure. Shop and erection drawings shall clearly distinguish between shop and field welds and bolts and shall clearly identify pretensioned and slip-critical high-strength bolted *connections*. Shop and erection drawings shall be made with due regard to speed and economy in fabrication and erection.

M2. FABRICATION

1. Cambering, Curving and Straightening

Local application of heat or mechanical means is permitted to be used to introduce or correct camber, curvature and straightness. The temperature of heated areas shall not exceed 1,100 °F (593 °C) for ASTM A514/A514M and ASTM A852/A852M steel nor 1,200 °F (649 °C) for other steels.

2. Thermal Cutting

Thermally cut edges shall meet the requirements of AWS D1.1/D1.1M, subclauses 5.15.1.2, 5.15.4.3 and 5.15.4.4 with the exception that thermally cut free edges that will not be subject to *fatigue* shall be free of round-bottom *gouges* greater than $\frac{3}{16}$ in. (5 mm) deep and sharp V-shaped notches. Gouges deeper than $\frac{3}{16}$ in. (5 mm) and notches shall be removed by grinding or repaired by welding.

Reentrant corners shall be formed with a curved transition. The radius need not exceed that required to fit the connection. The surface resulting from two straight torch cuts meeting at a point is not considered to be curved. Discontinuous corners are permitted where the material on both sides of the discontinuous reentrant corner are connected to a mating piece to prevent deformation and associated *stress concentration* at the corner.

User Note: Reentrant corners with a radius of $\frac{1}{2}$ to $\frac{3}{8}$ in. (13 to 10 mm) are acceptable for *statically loaded* work. Where pieces need to fit tightly together, a discontinuous reentrant corner is acceptable if the pieces are connected close to the corner on both sides of the discontinuous corner. Slots in *HSS* for gussets may be made with semicircular ends or with curved corners. Square ends are acceptable provided the edge of the gusset is welded to the *HSS*.

Weld access holes shall meet the geometrical requirements of Section J1.6. *Beam copes* and weld access holes in shapes that are to be galvanized shall be ground to bright metal. For shapes with a flange thickness not exceeding 2 in. (50 mm), the roughness of thermally cut surfaces of copes shall be no greater than a surface roughness value of 2,000 $\mu\text{in.}$ (50 μm) as defined in ASME B46.1. For beam copes and weld access holes in which the curved part of the access hole is thermally cut in ASTM A6/A6M hot-rolled shapes with a flange thickness exceeding 2 in. (50 mm) and welded *built-up shapes* with material thickness greater than 2 in. (50 mm), a pre-heat temperature of not less than 150 °F (66 °C) shall be applied prior to thermal cutting. The thermally cut surface of access holes in ASTM A6/A6M hot-rolled shapes with a flange thickness exceeding 2 in. (50 mm) and built-up shapes with a material thickness greater than 2 in. (50 mm) shall be ground.

User Note: The AWS Surface Roughness Guide for Oxygen Cutting (AWS C4.1-77) sample 2 may be used as a guide for evaluating the surface roughness of copes in shapes with flanges not exceeding 2 in. (50 mm) thick.

3. Planing of Edges

Planing or finishing of sheared or *thermally cut* edges of plates or shapes is not required unless specifically called for in the *construction documents* or included in a stipulated edge preparation for welding.

4. Welded Construction

The technique of welding, the workmanship, appearance, and quality of welds, and the methods used in correcting nonconforming work shall be in accordance with AWS D1.1/D1.1M except as modified in Section J2.

5. Bolted Construction

Parts of bolted members shall be pinned or bolted and rigidly held together during assembly. Use of a *drift* pin in bolt holes during assembly shall not distort the metal or enlarge the holes. Poor matching of holes shall be cause for rejection.

Bolt holes shall comply with the provisions of the RCSC *Specification for Structural Joints Using High-Strength Bolts*, hereafter referred to as the RCSC *Specification*, Section 3.3 except that *thermally cut* holes are permitted with a surface roughness profile not exceeding 1,000 $\mu\text{in.}$ (25 μm) as defined in ASME B46.1. *Gouges* shall not exceed a depth of $\frac{1}{16}$ in. (2 mm). Water jet cut holes are also permitted.

User Note: The AWS Surface Roughness Guide for Oxygen Cutting (AWS C4.1-77) sample 3 may be used as a guide for evaluating the surface roughness of thermally cut holes.

Fully inserted finger *shims*, with a total thickness of not more than $\frac{1}{4}$ in. (6 mm) within a *joint*, are permitted without changing the strength (based upon hole type) for the design of *connections*. The orientation of such shims is independent of the direction of application of the *load*.

The use of high-strength bolts shall conform to the requirements of the RCSC *Specification*, except as modified in Section J3.

6. Compression Joints

Compression *joints* that depend on contact *bearing* as part of the *splice* strength shall have the bearing surfaces of individual fabricated pieces prepared by milling, sawing or other suitable means.

7. Dimensional Tolerances

Dimensional tolerances shall be in accordance with Chapter 6 of the AISC *Code of Standard Practice for Steel Buildings and Bridges*, hereafter referred to as the *Code of Standard Practice*.

8. Finish of Column Bases

Column bases and base plates shall be finished in accordance with the following requirements:

- (1) Steel bearing plates 2 in. (50 mm) or less in thickness are permitted without milling provided a satisfactory contact bearing is obtained. Steel bearing plates over 2 in. (50 mm) but not over 4 in. (100 mm) in thickness are permitted to be straightened by pressing or, if presses are not available, by milling for bearing surfaces, except as noted in subparagraphs 2 and 3 of this section, to obtain a satisfactory contact bearing. Steel bearing plates over 4 in. (100 mm) in thickness shall be milled for bearing surfaces, except as noted in subparagraphs 2 and 3 of this section.
- (2) Bottom surfaces of bearing plates and column bases that are grouted to ensure full bearing contact on foundations need not be milled.
- (3) Top surfaces of bearing plates need not be milled when *complete-joint-penetration groove welds* are provided between the column and the bearing plate.

9. Holes for Anchor Rods

Holes for anchor rods are permitted to be *thermally cut* in accordance with the provisions of Section M2.2.

10. Drain Holes

When water can collect inside *HSS* or box members, either during construction or during service, the member shall be sealed, provided with a drain hole at the base, or protected by other suitable means.

11. Requirements for Galvanized Members

Members and parts to be galvanized shall be designed, detailed and fabricated to provide for flow and drainage of pickling fluids and zinc and to prevent pressure buildup in enclosed parts.

User Note: See *The Design of Products to be Hot-Dip Galvanized After Fabrication*, American Galvanizer's Association, and ASTM A123, A153, A384 and A780 for useful information on design and detailing of galvanized members. See Section M2.2 for requirements for *copies* of members to be galvanized.

M3. SHOP PAINTING

1. General Requirements

Shop painting and surface preparation shall be in accordance with the provisions in Chapter 6 of the *Code of Standard Practice*.

Shop paint is not required unless specified by the contract documents.

2. Inaccessible Surfaces

Except for contact surfaces, surfaces inaccessible after shop assembly shall be cleaned and painted prior to assembly, if required by the *construction documents*.

3. Contact Surfaces

Paint is permitted in *bearing-type connections*. For *slip-critical connections*, the *faying surface* requirements shall be in accordance with the *RCSC Specification*, Section 3.2.2(b).

4. Finished Surfaces

Machine-finished surfaces shall be protected against corrosion by a rust inhibitive coating that can be removed prior to erection, or which has characteristics that make removal prior to erection unnecessary.

5. Surfaces Adjacent to Field Welds

Unless otherwise specified in the design documents, surfaces within 2 in. (50 mm) of any field weld location shall be free of materials that would prevent proper welding or produce objectionable fumes during welding.

M4. ERECTION

1. Column Base Setting

Column bases shall be set level and to correct elevation with full bearing on concrete or masonry as defined in Chapter 7 of the *Code of Standard Practice*.

2. Stability and Connections

The frame of *structural steel* buildings shall be carried up true and plumb within the limits defined in Chapter 7 of the *Code of Standard Practice*. As erection progresses, the structure shall be secured to support dead, erection and other *loads* anticipated to occur during the period of erection. Temporary *bracing* shall be provided, in accordance with the requirements of the *Code of Standard Practice*, wherever necessary to support the loads to which the structure may be subjected, including equipment and the operation of same. Such bracing shall be left in place as long as required for safety.

3. Alignment

No permanent bolting or welding shall be performed until the adjacent affected portions of the structure have been properly aligned.

4. Fit of Column Compression Joints and Base Plates

Lack of contact bearing not exceeding a gap of $\frac{1}{16}$ in. (2 mm), regardless of the type of *splice* used (*partial-joint-penetration groove welded* or bolted), is permitted. If the gap exceeds $\frac{1}{16}$ in. (2 mm), but is equal to or less than $\frac{1}{4}$ in. (6 mm), and if an engineering investigation shows that sufficient contact area does not exist, the gap shall be packed out with nontapered steel *shims*. Shims need not be other than mild steel, regardless of the grade of the main material.

5. Field Welding

Surfaces in and adjacent to *joints* to be field welded shall be prepared as necessary to assure weld quality. This preparation shall include surface preparation necessary to correct for damage or contamination occurring subsequent to fabrication.

6. Field Painting

Responsibility for touch-up painting, cleaning and field painting shall be allocated in accordance with accepted local practices, and this allocation shall be set forth explicitly in the contract documents.

CHAPTER N

QUALITY CONTROL AND QUALITY ASSURANCE

This chapter addresses minimum requirements for *quality control*, *quality assurance* and *nondestructive testing* for *structural steel* systems and steel elements of composite members for buildings and other structures.

User Note: This chapter does not address quality control or quality assurance for concrete reinforcing bars, concrete materials or placement of concrete for composite members. This chapter does not address quality control or quality assurance for surface preparation or coatings.

User Note: The inspection of steel (open-web) joists and joist girders, tanks, pressure vessels, cables, cold-formed steel products, or gage metal products is not addressed in this Specification.

The Chapter is organized as follows:

- N1. Scope
- N2. Fabricator and Erector Quality Control Program
- N3. Fabricator and Erector Documents
- N4. Inspection and Nondestructive Testing Personnel
- N5. Minimum Requirements for Inspection of Structural Steel Buildings
- N6. Minimum Requirements for Inspection of Composite Construction
- N7. Approved Fabricators and Erectors
- N8. Nonconforming Material and Workmanship

N1. SCOPE

Quality control (QC) as specified in this chapter shall be provided by the fabricator and erector. *Quality assurance* (QA) as specified in this chapter shall be provided by others when required by the *authority having jurisdiction* (AHJ), *applicable building code* (ABC), purchaser, owner, or *engineer of record* (EOR). *Nondestructive testing* (NDT) shall be performed by the agency or firm responsible for quality assurance, except as permitted in accordance with Section N7.

User Note: The QA/QC requirements in Chapter N are considered adequate and effective for most steel structures and are strongly encouraged without modification. When the ABC and AHJ requires the use of a *quality assurance plan*, this chapter outlines the minimum requirements deemed effective to provide satisfactory results in steel building construction. There may be cases where supplemental inspections are advisable. Additionally, where the contractor's *quality control program* has demonstrated the capability to perform some tasks this plan has assigned to quality assurance, modification of the plan could be considered.

User Note: The producers of materials manufactured in accordance with standard *specifications* referenced in Section A3 in this Specification, and steel deck manufacturers, are not considered to be fabricators or erectors.

N2. FABRICATOR AND ERECTOR QUALITY CONTROL PROGRAM

The fabricator and erector shall establish and maintain *quality control* procedures and perform inspections to ensure that their work is performed in accordance with this Specification and the *construction documents*.

Material identification procedures shall comply with the requirements of Section 6.1 of the *Code of Standard Practice*, and shall be monitored by the fabricator's *quality control inspector* (QCI).

The fabricator's QCI shall inspect the following as a minimum, as applicable:

- (1) Shop welding, high-strength bolting, and details in accordance with Section N5
- (2) Shop cut and *finished surfaces* in accordance with Section M2
- (3) Shop heating for straightening, cambering and curving in accordance with Section M2.1
- (4) Tolerances for shop fabrication in accordance with Section 6 of the *Code of Standard Practice*

The erector's QCI shall inspect the following as a minimum, as applicable:

- (1) Field welding, high-strength bolting, and details in accordance with Section N5
- (2) Steel deck and headed steel stud anchor placement and attachment in accordance with Section N6
- (3) Field cut surfaces in accordance with Section M2.2
- (4) Field heating for straightening in accordance with Section M2.1
- (5) Tolerances for field erection in accordance with Section 7.13 of the *Code of Standard Practice*.

N3. FABRICATOR AND ERECTOR DOCUMENTS

1. Submittals for Steel Construction

The fabricator or erector shall submit the following documents for review by the *engineer of record* (EOR) or the EOR's designee, in accordance with Section 4 or A4.4 of the *Code of Standard Practice*, prior to fabrication or erection, as applicable:

- (1) Shop drawings, unless shop drawings have been furnished by others
- (2) Erection drawings, unless erection drawings have been furnished by others

2. Available Documents for Steel Construction

The following documents shall be available in electronic or printed form for review by the EOR or the EOR's designee prior to fabrication or erection, as applicable, unless otherwise required in the contract documents to be submitted:

- (1) For main *structural steel* elements, copies of material test reports in accordance with Section A3.1.
- (2) For steel castings and forgings, copies of material test reports in accordance with Section A3.2.
- (3) For *fasteners*, copies of manufacturer's certifications in accordance with Section A3.3.
- (4) For deck fasteners, copies of manufacturer's product data sheets or catalog data. The data sheets shall describe the product, limitations of use, and recommended or typical installation instructions.
- (5) For anchor rods and threaded rods, copies of material test reports in accordance with Section A3.4.
- (6) For welding consumables, copies of manufacturer's certifications in accordance with Section A3.5.
- (7) For headed stud anchors, copies of manufacturer's certifications in accordance with Section A3.6.
- (8) Manufacturer's product data sheets or catalog data for welding *filler metals* and fluxes to be used. The data sheets shall describe the product, limitations of use, recommended or typical welding parameters, and storage and exposure requirements, including baking, if applicable.
- (9) Welding procedure specifications (WPSs).
- (10) Procedure qualification records (PQRs) for WPSs that are not prequalified in accordance with AWS D1.1/D1.1M or AWS D1.3/D1.3M, as applicable.
- (11) Welding personnel performance qualification records (WPQR) and continuity records.
- (12) Fabricator's or erector's, as applicable, written quality control manual that shall include, as a minimum:
 - (i) Material control procedures
 - (ii) Inspection procedures
 - (iii) Nonconformance procedures
- (13) Fabricator's or erector's, as applicable, QC inspector qualifications.

N4. INSPECTION AND NONDESTRUCTIVE TESTING PERSONNEL

1. Quality Control Inspector Qualifications

Quality control (QC) welding inspection personnel shall be qualified to the satisfaction of the fabricator's or erector's QC program, as applicable, and in accordance with either of the following:

- (a) Associate welding inspectors (AWI) or higher as defined in AWS B5.1, *Standard for the Qualification of Welding Inspectors*, or
- (b) Qualified under the provisions of AWS D1.1/D1.1M subclause 6.1.4

QC bolting inspection personnel shall be qualified on the basis of documented training and experience in structural bolting inspection.

2. Quality Assurance Inspector Qualifications

Quality assurance (QA) welding inspectors shall be qualified to the satisfaction of the QA agency's written practice, and in accordance with either of the following:

- (a) Welding inspectors (WIs) or senior welding inspectors (SWIs), as defined in AWS B5.1, *Standard for the Qualification of Welding Inspectors*, except associate welding inspectors (AWIs) are permitted to be used under the direct supervision of WIs, who are on the premises and available when weld inspection is being conducted, or
- (b) Qualified under the provisions of AWS D1.1/D1.1M, subclause 6.1.4

QA bolting inspection personnel shall be qualified on the basis of documented training and experience in structural bolting inspection.

3. NDT Personnel Qualifications

Nondestructive testing personnel, for NDT other than visual, shall be qualified in accordance with their employer's written practice, which shall meet or exceed the criteria of AWS D1.1/D1.1M *Structural Welding Code—Steel*, subclause 6.14.6, and:

- (a) American Society for Nondestructive Testing (ASNT) SNT-TC-1A, *Recommended Practice for the Qualification and Certification of Nondestructive Testing Personnel*, or
- (b) ASNT CP-189, *Standard for the Qualification and Certification of Nondestructive Testing Personnel*.

N5. MINIMUM REQUIREMENTS FOR INSPECTION OF STRUCTURAL STEEL BUILDINGS

1. Quality Control

QC inspection tasks shall be performed by the fabricator's or erector's *quality control inspector* (QCI), as applicable, in accordance with Sections N5.4, N5.6 and N5.7.

Tasks in Tables N5.4-1 through N5.4-3 and Tables N5.6-1 through N5.6-3 listed for QC are those inspections performed by the QCI to ensure that the work is performed in accordance with the *construction documents*.

For QC inspection, the applicable construction documents are the *shop drawings* and the *erection drawings*, and the applicable referenced *specifications*, codes and standards.

User Note: The QCI need not refer to the *design drawings* and project specifications. The *Code of Standard Practice*, Section 4.2(a), requires the transfer of information from the Contract Documents (design drawings and project specification) into accurate and complete shop and erection drawings, allowing QC inspection to be based upon shop and erection drawings alone.

2. Quality Assurance

Quality assurance (QA) inspection of fabricated items shall be made at the fabricator's plant. The *quality assurance inspector* (QAI) shall schedule this work to minimize interruption to the work of the fabricator.

QA inspection of the erected steel system shall be made at the project site. The QAI shall schedule this work to minimize interruption to the work of the erector.

The QAI shall review the material test reports and certifications as listed in Section N3.2 for compliance with the *construction documents*.

QA inspection tasks shall be performed by the QAI, in accordance with Sections N5.4, N5.6 and N5.7.

Tasks in Tables N5.4-1 through N5.4-3 and N5.6-1 through N5.6-3 listed for QA are those inspections performed by the QAI to ensure that the work is performed in accordance with the construction documents.

Concurrent with the submittal of such reports to the AHJ, EOR or owner, the QA agency shall submit to the fabricator and erector:

- (1) Inspection reports
- (2) *Nondestructive testing* reports

3. Coordinated Inspection

Where a task is noted to be performed by both QC and QA, it is permitted to coordinate the inspection function between the QCI and QAI so that the inspection functions are performed by only one party. Where QA relies upon inspection functions performed by QC, the approval of the *engineer of record* and the *authority having jurisdiction* is required.

4. Inspection of Welding

Observation of welding operations and visual inspection of in-process and completed welds shall be the primary method to confirm that the materials, procedures and workmanship are in conformance with the *construction documents*. For *structural steel*, all provisions of AWS D1.1/D1.1M *Structural Welding Code—Steel for statically loaded structures* shall apply.

User Note: Section J2 of this Specification contains exceptions to AWS D1.1/D1.1M.

As a minimum, welding inspection tasks shall be in accordance with Tables N5.4-1, N5.4-2 and N5.4-3. In these tables, the inspection tasks are as follows:

O – Observe these items on a random basis. Operations need not be delayed pending these inspections.

P – Perform these tasks for each welded *joint* or member.

TABLE N5.4-1
Inspection Tasks Prior to Welding

Inspection Tasks Prior to Welding	QC	QA
Welding procedure specifications (WPSs) available	P	P
Manufacturer certifications for welding consumables available	P	P
Material identification (type/grade)	O	O
Welder identification system ¹	O	O
Fit-up of groove welds (including joint geometry) <ul style="list-style-type: none"> • Joint preparation • Dimensions (alignment, root opening, root face, bevel) • Cleanliness (condition of steel surfaces) • Tacking (tack weld quality and location) • Backing type and fit (if applicable) 	O	O
Configuration and finish of access holes	O	O
Fit-up of fillet welds <ul style="list-style-type: none"> • Dimensions (alignment, gaps at root) • Cleanliness (condition of steel surfaces) • Tacking (tack weld quality and location) 	O	O
Check welding equipment	O	—
¹ The fabricator or erector, as applicable, shall maintain a system by which a welder who has welded a joint or member can be identified. Stamps, if used, shall be the low-stress type.		

TABLE N5.4-2
Inspection Tasks During Welding

Inspection Tasks During Welding	QC	QA
Use of qualified welders	○	○
Control and handling of welding consumables <ul style="list-style-type: none"> • Packaging • Exposure control 	○	○
No welding over cracked tack welds	○	○
Environmental conditions <ul style="list-style-type: none"> • Wind speed within limits • Precipitation and temperature 	○	○
WPS followed <ul style="list-style-type: none"> • Settings on welding equipment • Travel speed • Selected welding materials • Shielding gas type/flow rate • Preheat applied • Interpass temperature maintained (min./max.) • Proper position (F, V, H, OH) 	○	○
Welding techniques <ul style="list-style-type: none"> • Interpass and final cleaning • Each pass within profile limitations • Each pass meets quality requirements 	○	○

TABLE N5.4-3
Inspection Tasks After Welding

Inspection Tasks After Welding	QC	QA
Welds cleaned	O	O
Size, length and location of welds	P	P
Welds meet visual acceptance criteria <ul style="list-style-type: none"> • Crack prohibition • Weld/base-metal fusion • Crater cross section • Weld profiles • Weld size • Undercut • Porosity 	P	P
Arc strikes	P	P
<i>k</i> -area ¹	P	P
Backing removed and weld tabs removed (if required)	P	P
Repair activities	P	P
Document acceptance or rejection of welded joint or member	P	P
¹ When welding of doubler plates, continuity plates or stiffeners has been performed in the <i>k</i> -area, visually inspect the web <i>k</i> -area for cracks within 3 in. (75 mm) of the weld.		

5. Nondestructive Testing of Welded Joints

5a. Procedures

Ultrasonic testing (UT), magnetic particle testing (MT), penetrant testing (PT) and radiographic testing (RT), where required, shall be performed by QA in accordance with AWS D1.1/D1.1M. Acceptance criteria shall be in accordance with AWS D1.1/D1.1M for *statically loaded* structures, unless otherwise designated in the *design drawings* or *project specifications*.

5b. CJP Groove Weld NDT

For structures in Risk Category III or IV of Table 1.5-1, Risk Category of Buildings and Other Structures for Flood, Wind, Snow, Earthquake and Ice Loads, of ASCE/SEI 7, *Minimum Design Loads for Buildings and Other Structures*, UT shall be performed by QA on all CJP groove welds subject to transversely applied tension loading in butt, T- and corner joints, in materials $\frac{5}{16}$ in. (8 mm) thick or greater. For structures in Risk Category II, UT shall be performed by QA on 10% of CJP groove welds in butt, T- and corner joints subject to transversely applied tension loading, in materials $\frac{5}{16}$ in. (8 mm) thick or greater.

User Note: For structures in Risk Category I, NDT of CJP groove welds is not required. For all structures in all Risk Categories, NDT of CJP groove welds in materials less than $\frac{5}{16}$ in. (8 mm) thick is not required.

5c. Access Hole NDT

Thermally cut surfaces of access holes shall be tested by QA using MT or PT, when the flange thickness exceeds 2 in. (50 mm) for rolled shapes, or when the web thickness exceeds 2 in. (50 mm) for *built-up shapes*. Any crack shall be deemed unacceptable regardless of size or location.

User Note: See Section M2.2.

5d. Welded Joints Subjected to Fatigue

When required by Appendix 3, Table A-3.1, welded joints requiring weld soundness to be established by radiographic or ultrasonic inspection shall be tested by QA as prescribed. Reduction in the rate of UT is prohibited.

5e. Reduction of Rate of Ultrasonic Testing

The rate of UT is permitted to be reduced if approved by the EOR and the AHJ. Where the initial rate for UT is 100%, the NDT rate for an individual welder or welding operator is permitted to be reduced to 25%, provided the reject rate, the number of welds containing unacceptable defects divided by the number of welds completed, is demonstrated to be 5% or less of the welds tested for the welder or welding operator. A sampling of at least 40 completed welds for a job shall be made for such reduction evaluation. For evaluating the reject rate of continuous welds over 3 ft (1 m) in length where the effective throat is 1 in. (25 mm) or less, each 12 in. (300 mm) increment or fraction thereof shall be considered as one weld. For evaluating the reject rate on continuous welds over 3 ft (1 m) in length where the effective throat is greater than 1 in. (25 mm), each 6 in. (150 mm) of length or fraction thereof shall be considered one weld.

5f. Increase in Rate of Ultrasonic Testing

For structures in Risk Category II, where the initial rate for UT is 10%, the NDT rate for an individual welder or welding operator shall be increased to 100% should the reject rate, the number of welds containing unacceptable defects divided by the number of welds completed, exceeds 5% of the welds tested for the welder or welding operator. A sampling of at least 20 completed welds for a job shall be made prior to implementing such an increase. When the reject rate for the welder or welding operator, after a sampling of at least 40 completed welds, has fallen to 5% or less, the rate of UT shall be returned to 10%. For evaluating the reject rate of continuous welds over 3 ft (1 m) in length where the effective throat is 1 in. (25 mm) or less,

each 12-in. (300 mm) increment or fraction thereof shall be considered as one weld. For evaluating the reject rate on continuous welds over 3 ft (1 m) in length where the effective throat is greater than 1 in. (25 mm), each 6 in. (150 mm) of length or fraction thereof shall be considered one weld.

5g. Documentation

All NDT performed shall be documented. For shop fabrication, the NDT report shall identify the tested weld by piece mark and location in the piece. For field work, the NDT report shall identify the tested weld by location in the structure, piece mark, and location in the piece.

When a weld is rejected on the basis of NDT, the NDT record shall indicate the location of the defect and the basis of rejection.

6. Inspection of High-Strength Bolting

Observation of bolting operations shall be the primary method used to confirm that the materials, procedures and workmanship incorporated in construction are in conformance with the *construction documents* and the provisions of the RCSC *Specification*.

- (1) For snug-tight joints, pre-installation verification testing as specified in Table N5.6-1 and monitoring of the installation procedures as specified in Table N5.6-2 are not applicable. The QCI and QAI need not be present during the installation of *fasteners* in snug-tight joints.
- (2) For *pretensioned joints* and slip-critical joints, when the installer is using the *turn-of-nut method* with matchmarking techniques, the direct-tension-indicator method, or the twist-off-type tension control bolt method, monitoring of bolt pretensioning procedures shall be as specified in Table N5.6-2. The QCI and QAI need not be present during the installation of fasteners when these methods are used by the installer.
- (3) For pretensioned joints and slip-critical joints, when the installer is using the calibrated wrench method or the turn-of-nut method without matchmarking, monitoring of bolt pretensioning procedures shall be as specified in Table N5.6-2. The QCI and QAI shall be engaged in their assigned inspection duties during installation of fasteners when these methods are used by the installer.

As a minimum, bolting inspection tasks shall be in accordance with Tables N5.6-1, N5.6-2 and N5.6-3. In these tables, the inspection tasks are as follows:

O – Observe these items on a random basis. Operations need not be delayed pending these inspections.

P – Perform these tasks for each bolted connection.

TABLE N5.6-1
Inspection Tasks Prior to Bolting

Inspection Tasks Prior to Bolting	QC	QA
Manufacturer's certifications available for fastener materials	O	P
Fasteners marked in accordance with ASTM requirements	O	O
Proper fasteners selected for the joint detail (grade, type, bolt length if threads are to be excluded from shear plane)	O	O
Proper bolting procedure selected for joint detail	O	O
Connecting elements, including the appropriate faying surface condition and hole preparation, if specified, meet applicable requirements	O	O
Pre-installation verification testing by installation personnel observed and documented for fastener assemblies and methods used	P	O
Proper storage provided for bolts, nuts, washers and other fastener components	O	O

TABLE N5.6-2
Inspection Tasks During Bolting

Inspection Tasks During Bolting	QC	QA
Fastener assemblies, of suitable condition, placed in all holes and washers (if required) are positioned as required	O	O
Joint brought to the snug-tight condition prior to the pretensioning operation	O	O
Fastener component not turned by the wrench prevented from rotating	O	O
Fasteners are pretensioned in accordance with the RCSC <i>Specification</i> , progressing systematically from the most rigid point toward the free edges	O	O

TABLE N5.6-3
Inspection Tasks After Bolting

Inspection Tasks After Bolting	QC	QA
Document acceptance or rejection of bolted connections	P	P

7. Other Inspection Tasks

The fabricator's QCI shall inspect the fabricated steel to verify compliance with the details shown on the shop drawings, such as proper application of *joint* details at each connection. The erector's QCI shall inspect the erected steel frame to verify compliance with the details shown on the erection drawings, such as braces, *stiffeners*, member locations and proper application of joint details at each connection.

The QAI shall be on the premises for inspection during the placement of anchor rods and other embedments supporting structural steel for compliance with the *construction documents*. As a minimum, the diameter, grade, type and length of the anchor rod or embedded item, and the extent or depth of embedment into the concrete, shall be verified prior to placement of concrete.

The QAI shall inspect the fabricated steel or erected steel frame, as appropriate, to verify compliance with the details shown on the construction documents, such as braces, stiffeners, member locations and proper application of joint details at each connection.

N6. MINIMUM REQUIREMENTS FOR INSPECTION OF COMPOSITE CONSTRUCTION

Inspection of structural steel and steel deck used in composite construction shall comply with the requirements of this Chapter.

For welding of steel headed stud anchors, the provisions of AWS D1.1/D1.1M, *Structural Welding Code—Steel*, apply.

For welding of steel deck, observation of welding operations and visual inspection of in-process and completed welds shall be the primary method to confirm that the materials, procedures and workmanship are in conformance with the *construction documents*. All applicable provisions of AWS D1.3/D1.3M, *Structural Welding Code—Sheet Steel*, shall apply. Deck welding inspection shall include verification of the welding consumables, welding procedure *specifications* and qualifications of welding personnel prior to the start of the work, observations of the work in progress, and a visual inspection of all completed welds. For steel deck attached by fastening systems other than welding, inspection shall include verification of the *fasteners* to be used prior to the start of the work, observations of the work in progress to confirm installation in conformance with the manufacturer's recommendations, and a visual inspection of the completed installation.

For those items for *quality control* (QC) in Table N6.1 that contain an observe designation, the QC inspection shall be performed by the erector's *quality control inspector* (QCI). In Table N6.1, the inspection tasks are as follows:

O – Observe these items on a random basis. Operations need not be delayed pending these inspections.

P – Perform these tasks for each steel element.

TABLE N6.1
Inspection of Steel Elements of Composite Construction Prior to Concrete Placement

Inspection of Steel Elements of Composite Construction Prior to Concrete Placement	QC	QA
Placement and installation of steel deck	P	P
Placement and installation of steel headed stud anchors	P	P
Document acceptance or rejection of steel elements	P	P

N7. APPROVED FABRICATORS AND ERECTORS

Quality assurance (QA) inspections, except *nondestructive testing (NDT)*, may be waived when the work is performed in a fabricating shop or by an erector approved by the *authority having jurisdiction (AHJ)* to perform the work without QA. NDT of welds completed in an approved fabricator's shop may be performed by that fabricator when approved by the AHJ. When the fabricator performs the NDT, the QA agency shall review the fabricator's NDT reports.

At completion of fabrication, the approved fabricator shall submit a certificate of compliance to the AHJ stating that the materials supplied and work performed by the fabricator are in accordance with the *construction documents*. At completion of erection, the approved erector shall submit a certificate of compliance to the AHJ stating that the materials supplied and work performed by the erector are in accordance with the construction documents.

N8. NONCONFORMING MATERIAL AND WORKMANSHIP

Identification and rejection of material or workmanship that is not in conformance with the *construction documents* shall be permitted at any time during the progress of the work. However, this provision shall not relieve the owner or the inspector of the obligation for timely, in-sequence inspections. Nonconforming material and workmanship shall be brought to the immediate attention of the fabricator or erector, as applicable.

Nonconforming material or workmanship shall be brought into conformance, or made suitable for its intended purpose as determined by the *engineer of record*.

Concurrent with the submittal of such reports to the AHJ, EOR or owner, the QA agency shall submit to the fabricator and erector:

- (1) Nonconformance reports
- (2) Reports of repair, replacement or acceptance of nonconforming items

APPENDIX 1

DESIGN BY INELASTIC ANALYSIS

This appendix addresses design by *inelastic analysis*, in which consideration of the redistribution of member and connection forces and moments as a result of localized yielding is permitted.

The appendix is organized as follows:

- 1.1. General Requirements
- 1.2. Ductility Requirements
- 1.3. Analysis Requirements

1.1. GENERAL REQUIREMENTS

Design by *inelastic analysis* shall be conducted in accordance with Section B3.3, using *load and resistance factor design* (LRFD). The *design strength* of the *structural system* and its members and connections shall equal or exceed the *required strength* as determined by the inelastic analysis. The provisions of this Appendix do not apply to seismic design.

The inelastic analysis shall take into account: (1) flexural, shear and axial member deformations, and all other component and *connection* deformations that contribute to the displacements of the structure; (2) *second-order effects* (including *P-Δ* and *P-δ effects*); (3) geometric imperfections; (4) *stiffness* reductions due to inelasticity, including the effect of residual *stresses* and partial yielding of the cross section; and (5) uncertainty in system, member, and connection strength and stiffness.

Strength limit states detected by an inelastic analysis that incorporates all of the above requirements are not subject to the corresponding provisions of the Specification when a comparable or higher level of reliability is provided by the analysis. Strength limit states not detected by the inelastic analysis shall be evaluated using the corresponding provisions of Chapters D, E, F, G, H, I, J and K.

Connections shall meet the requirements of Section B3.6.

Members and connections subject to inelastic deformations shall be shown to have adequate ductility consistent with the intended behavior of the structural system. Force redistribution due to rupture of a member or connection is not permitted.

Any method that uses inelastic analysis to proportion members and connections to satisfy these general requirements is permitted. A design method based on inelastic analysis that meets the above strength requirements, the ductility requirements of Section 1.2, and the analysis requirements of Section 1.3 satisfies these general requirements.

1.2. DUCTILITY REQUIREMENTS

Members and connections with elements subject to yielding shall be proportioned such that all inelastic deformation demands are less than or equal to their inelastic deformation capacities. In lieu of explicitly ensuring that the inelastic deformation demands are less than or equal to their inelastic deformation capacities, the following requirements shall be satisfied for steel members subject to plastic hinging.

1. Material

The *specified minimum yield stress*, F_y , of members subject to plastic hinging shall not exceed 65 ksi (450 MPa).

2. Cross Section

The cross section of members at *plastic hinge* locations shall be doubly symmetric with width-to-thickness ratios of their compression elements not exceeding λ_{pd} , where λ_{pd} is equal to λ_p from Table B4.1b except as modified below:

(a) For the width-to-thickness ratio, h/t_w , of webs of I-shaped sections, rectangular HSS, and box-shaped sections subject to combined flexure and compression

(i) When $P_u/\phi_c P_y \leq 0.125$

$$\lambda_{pd} = 3.76 \sqrt{\frac{E}{F_y}} \left(1 - \frac{2.75 P_u}{\phi_c P_y} \right) \quad (\text{A-1-1})$$

(ii) When $P_u/\phi_c P_y > 0.125$

$$\lambda_{pd} = 1.12 \sqrt{\frac{E}{F_y}} \left(2.33 - \frac{P_u}{\phi_c P_y} \right) \geq 1.49 \sqrt{\frac{E}{F_y}} \quad (\text{A-1-2})$$

where

h = as defined in Section B4.1, in. (mm)

t_w = web thickness, in. (mm)

P_u = *required axial strength* in compression, kips (N)

$P_y = F_y A_g$ = *axial yield strength*, kips (N)

ϕ_c = *resistance factor* for compression = 0.90

(b) For the width-to-thickness ratio, b/t , of flanges of rectangular HSS and box-shaped sections, and for flange *cover plates*, and *diaphragm plates* between lines of *fasteners* or welds

$$\lambda_{pd} = 0.94 \sqrt{E / F_y} \quad (\text{A-1-3})$$

where

b = as defined in Section B4.1, in. (mm)

t = as defined in Section B4.1, in. (mm)

(c) For the diameter-to-thickness ratio, D/t , of circular HSS in flexure

$$\lambda_{pd} = 0.045E/F_y \quad (\text{A-1-4})$$

where

D = outside diameter of round HSS, in. (mm)

3. Unbraced Length

In prismatic member segments that contain *plastic hinges*, the laterally *unbraced length*, L_b , shall not exceed L_{pd} , determined as follows. For members subject to flexure only, or to flexure and axial tension, L_b shall be taken as the length between points braced against lateral displacement of the compression flange, or between points braced to prevent twist of the cross section. For members subject to flexure and axial compression, L_b shall be taken as the length between points braced against both lateral displacement in the minor axis direction and twist of the cross section.

(a) For I-shaped members bent about their major axis:

$$L_{pd} = \left[0.12 - 0.076 \frac{M_1'}{M_2} \right] \frac{E}{F_y} r_y \quad (\text{A-1-5})$$

where

r_y = radius of gyration about minor axis, in. (mm)

(i) When the magnitude of the bending moment at any location within the unbraced length exceeds M_2

$$M_1' / M_2 = +1 \quad (\text{A-1-6a})$$

Otherwise:

(ii) When $M_{mid} \leq (M_1 + M_2)/2$

$$M_1' = M_1 \quad (\text{A-1-6b})$$

(iii) When $M_{mid} > (M_1 + M_2)/2$

$$M_1' = 2M_{mid} - M_2 < M_2 \quad (\text{A-1-6c})$$

where

M_1 = smaller moment at end of unbraced length, kip-in. (N-mm)

M_2 = larger moment at end of unbraced length, kip-in. (N-mm). M_2 shall be taken as positive in all cases.

M_{mid} = moment at middle of unbraced length, kip-in. (N-mm)

M_1' = effective moment at end of unbraced length opposite from M_2 , kip-in. (N-mm)

The moments M_1 and M_{mid} are individually taken as positive when they cause compression in the same flange as the moment M_2 and negative otherwise.

- (b) For solid rectangular bars and for rectangular *HSS* and box-shaped members bent about their major axis

$$L_{pd} = \left[0.17 - 0.10 \frac{M_1'}{M_2} \right] \frac{E}{F_y} r_y \geq 0.10 \frac{E}{F_y} r_y \quad (\text{A-1-7})$$

For all types of members subject to axial compression and containing plastic hinges, the laterally unbraced lengths about the cross section major and minor axes shall not exceed $4.71r_x\sqrt{E/F_y}$ and $4.71r_y\sqrt{E/F_y}$, respectively.

There is no L_{pd} limit for member segments containing plastic hinges in the following cases:

- (1) Members with circular or square cross sections subject only to flexure or to combined flexure and tension
- (2) Members subject only to flexure about their minor axis or combined tension and flexure about their minor axis
- (3) Members subject only to tension

4. Axial Force

To assure adequate ductility in compression members with *plastic hinges*, the *design strength* in compression shall not exceed $0.75F_yA_g$.

1.3. ANALYSIS REQUIREMENTS

The *structural analysis* shall satisfy the general requirements of Section 1.1. These requirements are permitted to be satisfied by a second-order *inelastic analysis* meeting the requirements of this Section.

Exception:

For continuous *beams* not subject to axial compression, a first-order inelastic or *plastic analysis* is permitted and the requirements of Sections 1.3.2 and 1.3.3 are waived.

User Note: Refer to the Commentary for guidance in conducting a traditional plastic analysis and design in conformance with these provisions.

1. Material Properties and Yield Criteria

The *specified minimum yield stress*, F_y , and the *stiffness* of all steel members and connections shall be reduced by a factor of 0.90 for the analysis, except as noted below in Section 1.3.3.

The influence of axial force, major axis bending moment, and minor axis bending moment shall be included in the calculation of the inelastic response.

The plastic strength of the member cross section shall be represented in the analysis either by an elastic-perfectly-plastic yield criterion expressed in terms of the axial

force, major axis bending moment, and minor axis bending moment, or by explicit modeling of the material *stress-strain* response as elastic-perfectly-plastic.

2. Geometric Imperfections

The analysis shall include the effects of initial geometric imperfections. This shall be done by explicitly modeling the imperfections as specified in Section C2.2a or by the application of equivalent *notional loads* as specified in Section C2.2b.

3. Residual Stress and Partial Yielding Effects

The analysis shall include the influence of residual *stresses* and partial yielding. This shall be done by explicitly modeling these effects in the analysis or by reducing the *stiffness* of all *structural components* as specified in Section C2.3.

If the provisions of Section C2.3 are used, then:

- (1) The 0.9 stiffness reduction factor specified in Section 1.3.1 shall be replaced by the reduction of the elastic modulus E by 0.8 as specified in Section C2.3, and
- (2) The elastic-perfectly-plastic yield criterion, expressed in terms of the axial force, major axis bending moment, and minor axis bending moment, shall satisfy the cross section strength limit defined by Equations H1-1a and H1-1b using $P_c = 0.9P_y$, $M_{cx} = 0.9M_{px}$ and $M_{cy} = 0.9M_{py}$.

APPENDIX 2

DESIGN FOR PONDING

This appendix provides methods for determining whether a roof system has adequate strength and *stiffness* to resist *ponding*.

The appendix is organized as follows:

- 2.1. Simplified Design for Ponding
- 2.2. Improved Design for Ponding

2.1. SIMPLIFIED DESIGN FOR PONDING

The roof system shall be considered stable for *ponding* and no further investigation is needed if both of the following two conditions are met:

$$C_p + 0.9C_s \leq 0.25 \quad (\text{A-2-1})$$

$$I_d \geq 25(S^4)10^{-6} \quad (\text{A-2-2})$$

$$(\text{S.I.: } I_d \geq 3\,940\,S^4) \quad (\text{A-2-2M})$$

where

$$C_p = \frac{32L_sL_p^4}{10^7 I_p} \quad (\text{A-2-3})$$

$$C_p = \frac{504L_sL_p^4}{I_p} \quad (\text{S.I.}) \quad (\text{A-2-3M})$$

$$C_s = \frac{32SL_s^4}{10^7 I_s} \quad (\text{A-2-4})$$

$$C_s = \frac{504SL_s^4}{I_s} \quad (\text{S.I.}) \quad (\text{A-2-4M})$$

I_d = moment of inertia of the steel deck supported on secondary members, in.⁴ per ft (mm⁴ per m)

I_p = moment of inertia of primary members, in.⁴ (mm⁴)

I_s = moment of inertia of secondary members, in.⁴ (mm⁴)

L_p = length of primary members, ft (m)

L_s = length of secondary members, ft (m)

S = spacing of secondary members, ft (m)

For trusses and steel joists, the calculation of the moments of inertia, I_p and I_s , shall include the effects of web member strain when used in the above equation.

User Note: When the moment of inertia is calculated using only the truss or joist chord areas, the reduction in the moment of inertia due to web strain can typically be taken as 15%.

A steel deck shall be considered a secondary member when it is directly supported by the primary members.

2.2. IMPROVED DESIGN FOR PONDING

The provisions given below are to be used when a more accurate evaluation of framing *stiffness* is needed than that given by Equations A-2-1 and A-2-2.

Define the *stress* indexes

$$U_p = \left(\frac{0.8F_y - f_o}{f_o} \right)_p \quad \text{for the primary member} \quad (\text{A-2-5})$$

$$U_s = \left(\frac{0.8F_y - f_o}{f_o} \right)_s \quad \text{for the secondary member} \quad (\text{A-2-6})$$

where

f_o = stress due to $D + R$ (D = nominal dead load, R = nominal load due to rainwater or snow exclusive of the *ponding* contribution), ksi (MPa)

For roof framing consisting of primary and secondary members, evaluate the combined stiffness as follows. Enter Figure A-2.1 at the level of the computed stress index, U_p , determined for the primary *beam*; move horizontally to the computed C_s value of the secondary beams and then downward to the abscissa scale. The combined stiffness of the primary and secondary framing is sufficient to prevent ponding if the flexibility coefficient read from this latter scale is more than the value of C_p computed for the given primary member; if not, a stiffer primary or secondary beam, or combination of both, is required.

A similar procedure must be followed using Figure A-2.2.

For roof framing consisting of a series of equally spaced wall bearing beams, evaluate the stiffness as follows. The beams are considered as secondary members supported on an infinitely stiff primary member. For this case, enter Figure A-2.2 with the computed stress index, U_s . The limiting value of C_s is determined by the intercept of a horizontal line representing the U_s value and the curve for $C_p = 0$.

User Note: The ponding deflection contributed by a metal deck is usually such a small part of the total ponding deflection of a roof panel that it is sufficient merely to limit its moment of inertia [per foot (meter) of width normal to its span] to 0.000025 (3 940) times the fourth power of its span length.

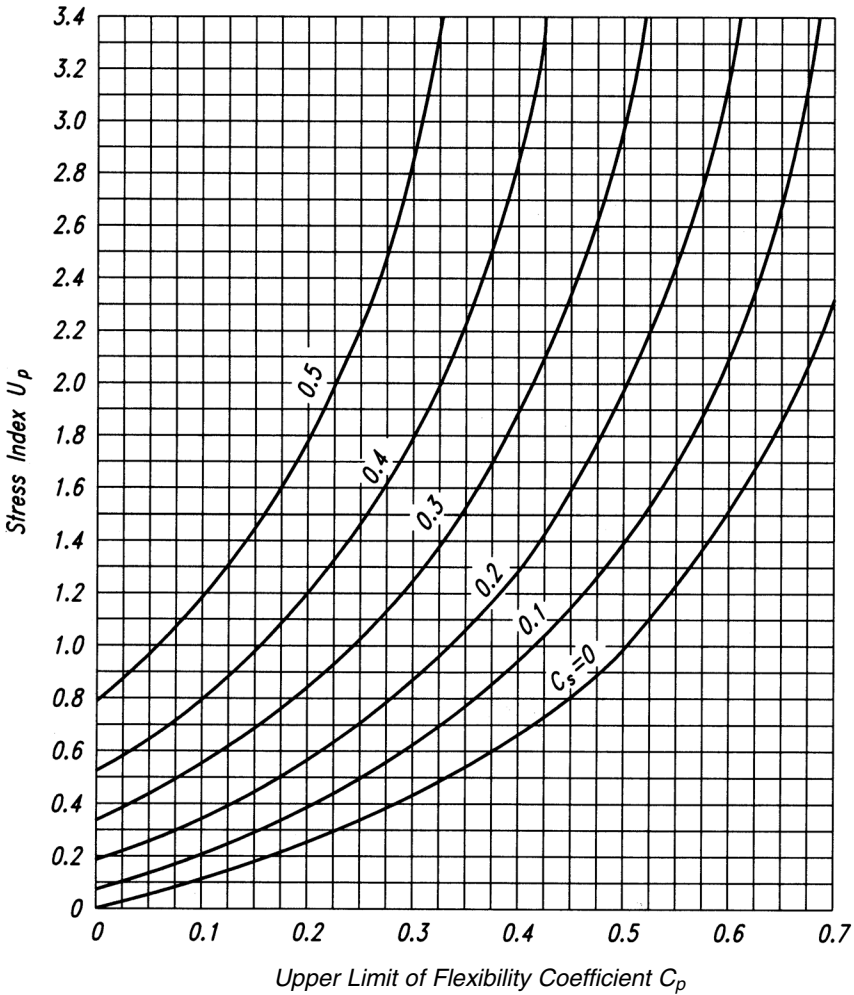

Fig. A-2.1. Limiting flexibility coefficient for the primary systems.

Evaluate the *stability* against ponding of a roof consisting of a metal roof deck of relatively slender depth-to-span ratio, spanning between beams supported directly on *columns*, as follows. Use Figure A-2.1 or A-2.2, using as C_s the flexibility coefficient for a one-foot (one-meter) width of the roof deck ($S = 1.0$).

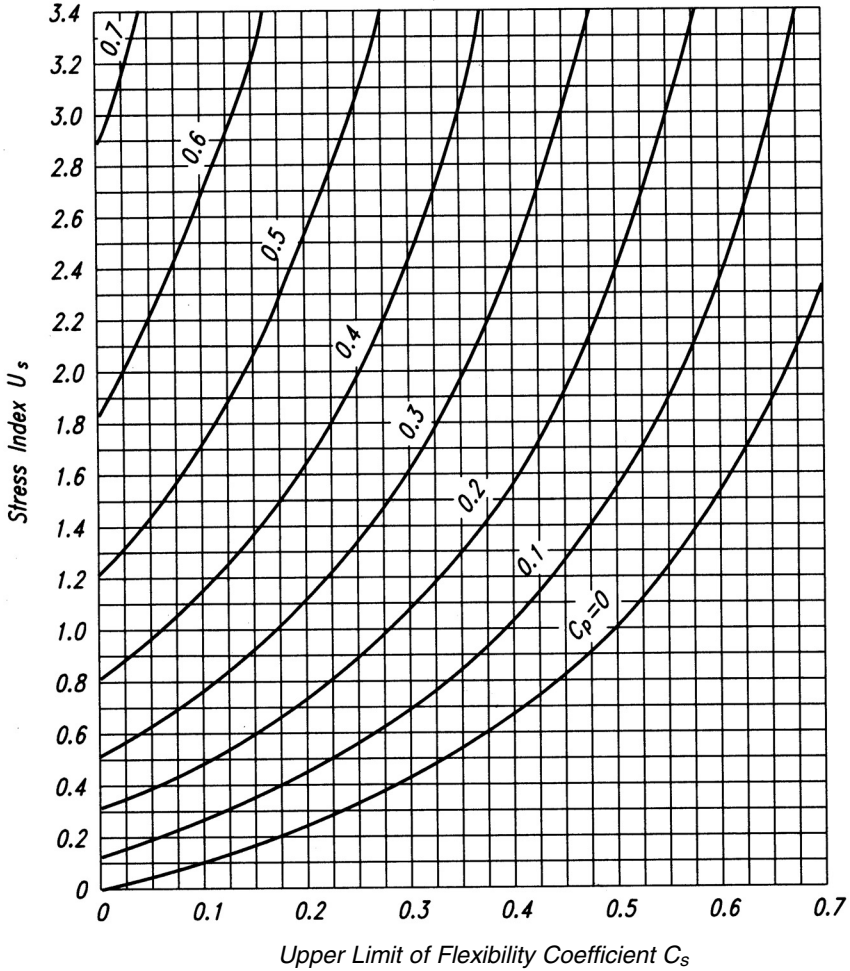

Fig. A-2.2. Limiting flexibility coefficient for the secondary systems.

APPENDIX 3

DESIGN FOR FATIGUE

This appendix applies to members and *connections* subject to high cycle loading within the elastic range of *stresses* of frequency and magnitude sufficient to initiate cracking and progressive failure, which defines the *limit state of fatigue*.

User Note: See AISC *Seismic Provisions for Structural Steel Buildings* for structures subject to seismic loads.

The appendix is organized as follows:

- 3.1. General Provisions
- 3.2. Calculation of Maximum Stresses and Allowable Stress Ranges
- 3.3. Plain Material and Welded Joints
- 3.4. Bolts and Threaded Parts
- 3.5. Special Fabrication and Erection Requirements

3.1. GENERAL PROVISIONS

The provisions of this Appendix apply to *stresses* calculated on the basis of *service loads*. The maximum permitted stress due to service loads is $0.66F_y$.

Stress range is defined as the magnitude of the change in stress due to the application or removal of the service live load. In the case of a stress reversal, the stress range shall be computed as the numerical sum of maximum repeated tensile and compressive stresses or the numerical sum of maximum shearing stresses of opposite direction at the point of probable crack initiation.

In the case of *complete-joint-penetration groove welds*, the maximum *allowable stress* range calculated by Equation A-3-1 applies only to welds that have been ultrasonically or radiographically tested and meet the acceptance requirements of Sections 6.12.2 or 6.13.2 of AWS D1.1/D1.1M.

No evaluation of *fatigue* resistance is required if the live load stress range is less than the threshold allowable stress range, F_{TH} . See Table A-3.1.

No evaluation of fatigue resistance of members consisting of shapes or plate is required if the number of cycles of application of live load is less than 20,000. No evaluation of fatigue resistance of members consisting of *HSS* in building-type structures subject to code mandated wind loads is required.

The cyclic load resistance determined by the provisions of this Appendix is applicable to structures with suitable corrosion protection or subject only to mildly corrosive atmospheres, such as normal atmospheric conditions.

The cyclic *load* resistance determined by the provisions of this Appendix is applicable only to structures subject to temperatures not exceeding 300 °F (150 °C).

The *engineer of record* shall provide either complete details including weld sizes or shall specify the planned cycle life and the maximum range of moments, shears and reactions for the *connections*.

3.2. CALCULATION OF MAXIMUM STRESSES AND STRESS RANGES

Calculated *stresses* shall be based upon *elastic analysis*. Stresses shall not be amplified by *stress concentration* factors for geometrical discontinuities.

For bolts and threaded rods subject to axial tension, the calculated stresses shall include the effects of *prying action*, if any. In the case of axial stress combined with bending, the maximum stresses, of each kind, shall be those determined for concurrent arrangements of the applied *load*.

For members having symmetric cross sections, the *fasteners* and welds shall be arranged symmetrically about the axis of the member, or the total stresses including those due to eccentricity shall be included in the calculation of the stress range.

For axially loaded angle members where the center of gravity of the connecting welds lies between the line of the center of gravity of the angle cross section and the center of the connected leg, the effects of eccentricity shall be ignored. If the center of gravity of the connecting welds lies outside this zone, the total stresses, including those due to *joint eccentricity*, shall be included in the calculation of stress range.

3.3. PLAIN MATERIAL AND WELDED JOINTS

In plain material and welded joints the range of *stress* at *service loads* shall not exceed the *allowable stress* range computed as follows.

- (a) For stress categories A, B, B', C, D, E and E' the allowable stress range, F_{SR} , shall be determined by Equation A-3-1 or A-3-1M, as follows:

$$F_{SR} = \left(\frac{C_f}{n_{SR}} \right)^{0.333} \geq F_{TH} \quad (\text{A-3-1})$$

$$F_{SR} = \left(\frac{C_f \times 329}{n_{SR}} \right)^{0.333} \geq F_{TH} \quad (\text{S.I.}) \quad (\text{A-3-1M})$$

where

C_f = constant from Table A-3.1 for the *fatigue* category

F_{SR} = allowable stress range, ksi (MPa)

F_{TH} = threshold allowable stress range, maximum stress range for indefinite design life from Table A-3.1, ksi (MPa)

n_{SR} = number of stress range fluctuations in design life

= number of stress range fluctuations per day \times 365 \times years of design life

- (b) For stress category F, the allowable stress range, F_{SR} , shall be determined by Equation A-3-2 or A-3-2M as follows:

$$F_{SR} = \left(\frac{C_f}{n_{SR}} \right)^{0.167} \geq F_{TH} \quad (\text{A-3-2})$$

$$F_{SR} = \left(\frac{C_f (11 \times 10^4)}{n_{SR}} \right)^{0.167} \geq F_{TH} \quad (\text{S.I.}) \quad (\text{A-3-2M})$$

- (c) For tension-loaded plate elements connected at their end by cruciform, T or corner details with *complete-joint-penetration (CJP) groove welds* or *partial-joint-penetration (PJP) groove welds, fillet welds*, or combinations of the preceding, transverse to the direction of stress, the allowable stress range on the cross section of the tension-loaded plate element at the toe of the weld shall be determined as follows:

- (i) Based upon crack initiation from the toe of the weld on the tension loaded plate element the allowable stress range, F_{SR} , shall be determined by Equation A-3-3 or A-3-3M, for stress category C as follows:

$$F_{SR} = \left(\frac{44 \times 10^8}{n_{SR}} \right)^{0.333} \geq 10 \quad (\text{A-3-3})$$

$$F_{SR} = \left(\frac{14.4 \times 10^{11}}{n_{SR}} \right)^{0.333} \geq 68.9 \quad (\text{S.I.}) \quad (\text{A-3-3M})$$

- (ii) Based upon crack initiation from the root of the weld the allowable stress range, F_{SR} , on the tension loaded plate element using transverse PJP groove welds, with or without reinforcing or contouring fillet welds, the allowable stress range on the cross section at the toe of the weld shall be determined by Equation A-3-4 or A-3-4M, for stress category C' as follows:

$$F_{SR} = R_{PJP} \left(\frac{44 \times 10^8}{n_{SR}} \right)^{0.333} \quad (\text{A-3-4})$$

$$F_{SR} = R_{PJP} \left(\frac{14.4 \times 10^{11}}{n_{SR}} \right)^{0.333} \quad (\text{S.I.}) \quad (\text{A-3-4M})$$

where

R_{PJP} , the reduction factor for reinforced or nonreinforced transverse PJP groove welds, is determined as follows:

$$R_{PJP} = \left(\frac{0.65 - 0.59 \left(\frac{2a}{t_p} \right) + 0.72 \left(\frac{w}{t_p} \right)}{t_p^{0.167}} \right) \leq 1.0 \quad (\text{A-3-5})$$

$$R_{PJP} = \left(\frac{1.12 - 1.01 \left(\frac{2a}{t_p} \right) + 1.24 \left(\frac{w}{t_p} \right)}{t_p^{0.167}} \right) \leq 1.0 \quad (\text{S.I.}) \quad (\text{A-3-5M})$$

If $R_{PJP} = 1.0$, use stress category C.

$2a$ = length of the nonwelded root face in the direction of the thickness of the tension-loaded plate, in. (mm)

w = leg size of the reinforcing or contouring fillet, if any, in the direction of the thickness of the tension-loaded plate, in. (mm)

t_p = thickness of tension loaded plate, in. (mm)

- (iii) Based upon crack initiation from the roots of a pair of transverse fillet welds on opposite sides of the tension loaded plate element, the allowable stress range, F_{SR} , on the cross section at the toe of the welds shall be determined by Equation A-3-6 or A-3-6M, for stress category C'' as follows:

$$F_{SR} = R_{FIL} \left(\frac{44 \times 10^8}{n_{SR}} \right)^{0.333} \quad (\text{A-3-6})$$

$$F_{SR} = R_{FIL} \left(\frac{14.4 \times 10^{11}}{n_{SR}} \right)^{0.333} \quad (\text{S.I.}) \quad (\text{A-3-6M})$$

where

R_{FIL} is the reduction factor for joints using a pair of transverse fillet welds only.

$$R_{FIL} = \left(\frac{0.06 + 0.72(w/t_p)}{t_p^{0.167}} \right) \leq 1.0 \quad (\text{A-3-7})$$

$$R_{FIL} = \left(\frac{0.10 + 1.24(w/t_p)}{t_p^{0.167}} \right) \leq 1.0 \quad (\text{S.I.}) \quad (\text{A-3-7M})$$

If $R_{FIL} = 1.0$, use stress category C.

3.4. BOLTS AND THREADED PARTS

In bolts and threaded parts, the range of *stress at service loads* shall not exceed the *allowable stress* range computed as follows.

- (a) For mechanically fastened *connections* loaded in shear, the maximum range of stress in the connected material at service loads shall not exceed the allowable stress range computed using Equation A-3-1 where C_f and F_{TH} are taken from Section 2 of Table A-3.1.
- (b) For high-strength bolts, common bolts and threaded anchor rods with cut, ground or rolled threads, the maximum range of tensile stress on the net tensile area from applied axial *load* and moment plus load due to *prying action* shall not exceed the allowable stress range computed using Equation A-3-8 or A-3-8M (stress category G). The *net area* in tension, A_t , is given by Equation A-3-9 or A-3-9M.

$$F_{SR} = \left(\frac{3.9 \times 10^8}{n_{SR}} \right)^{0.333} \geq 7 \quad (\text{A-3-8})$$

$$F_{SR} = \left(\frac{1.28 \times 10^{11}}{n_{SR}} \right)^{0.333} \geq 48 \quad (\text{S.I.}) \quad (\text{A-3-8M})$$

$$A_t = \frac{\pi}{4} \left(d_b - \frac{0.9743}{n} \right)^2 \quad (\text{A-3-9})$$

$$A_t = \frac{\pi}{4} (d_b - 0.9382p)^2 \quad (\text{S.I.}) \quad (\text{A-3-9M})$$

where

d_b = the nominal diameter (body or shank diameter), in. (mm)

n = threads per in. (threads per mm)

p = *pitch*, in. per thread (mm per thread)

For *joints* in which the material within the *grip* is not limited to steel or joints which are not tensioned to the requirements of Table J3.1 or J3.1M, all axial load and moment applied to the *joint* plus effects of any prying action shall be assumed to be carried exclusively by the bolts or rods.

For joints in which the material within the grip is limited to steel and which are pretensioned to the requirements of Table J3.1 or J3.1M, an analysis of the relative *stiffness* of the connected parts and bolts shall be permitted to be used to determine the tensile stress range in the *pretensioned bolts* due to the total service live load and moment plus effects of any prying action. Alternatively, the stress range in the bolts shall be assumed to be equal to the stress on the net tensile area due to 20% of the absolute value of the service load axial load and moment from dead, live and other loads.

3.5. SPECIAL FABRICATION AND ERECTION REQUIREMENTS

Longitudinal backing bars are permitted to remain in place, and if used, shall be continuous. If splicing is necessary for long *joints*, the bar shall be joined with complete penetration butt joints and the reinforcement ground prior to assembly in the joint. Longitudinal backing, if left in place, shall be attached with continuous *fillet welds*.

In transverse joints subject to tension, backing bars, if used, shall be removed and the joint back gouged and welded.

In transverse complete-joint-penetration T and corner joints, a reinforcing fillet weld, not less than $\frac{1}{4}$ in. (6 mm) in size shall be added at *reentrant* corners.

The surface roughness of *thermally cut* edges subject to cyclic *stress* ranges, that include tension, shall not exceed 1,000 $\mu\text{in.}$ (25 μm), where ASME B46.1 is the reference standard.

User Note: AWS C4.1 Sample 3 may be used to evaluate compliance with this requirement.

Reentrant corners at cuts, *cope*s and weld access holes shall form a radius of not less than $\frac{3}{8}$ in. (10 mm) by predrilling or subpunching and reaming a hole, or by thermal cutting to form the radius of the cut. If the radius portion is formed by thermal cutting, the cut surface shall be ground to a bright metal surface.

For transverse butt joints in regions of tensile stress, weld tabs shall be used to provide for cascading the weld termination outside the finished joint. End dams shall not be used. Run-off tabs shall be removed and the end of the weld finished flush with the edge of the member.

See Section J2.2b for requirements for *end returns* on certain fillet welds subject to cyclic service loading.

TABLE A-3.1
Fatigue Design Parameters

Description	Stress Category	Constant C_f	Threshold F_{TH} ksi (MPa)	Potential Crack Initiation Point
SECTION 1 – PLAIN MATERIAL AWAY FROM ANY WELDING				
1.1 Base metal, except noncoated weathering steel, with rolled or cleaned surface. Flame-cut edges with surface roughness value of 1,000 $\mu\text{in.}$ (25 μm) or less, but without reentrant corners.	A	250×10^8	24 (165)	Away from all welds or structural connections
1.2 Noncoated weathering steel base metal with rolled or cleaned surface. Flame-cut edges with surface roughness value of 1,000 $\mu\text{in.}$ (25 μm) or less, but without reentrant corners.	B	120×10^8	16 (110)	Away from all welds or structural connections
1.3 Member with drilled or reamed holes. Member with re-entrant corners at copes, cuts, block-outs or other geometrical discontinuities made to requirements of Appendix 3, Section 3.5, except weld access holes.	B	120×10^8	16 (110)	At any external edge or at hole perimeter
1.4 Rolled cross sections with weld access holes made to requirements of Section J1.6 and Appendix 3, Section 3.5. Members with drilled or reamed holes containing bolts for attachment of light bracing where there is a small longitudinal component of brace force.	C	44×10^8	10 (69)	At reentrant corner of weld access hole or at any small hole (may contain bolt for minor connections)
SECTION 2 – CONNECTED MATERIAL IN MECHANICALLY FASTENED JOINTS				
2.1 Gross area of base metal in lap joints connected by high-strength bolts in joints satisfying all requirements for slip-critical connections.	B	120×10^8	16 (110)	Through gross section near hole
2.2 Base metal at net section of high-strength bolted joints, designed on the basis of bearing resistance, but fabricated and installed to all requirements for slip-critical connections.	B	120×10^8	16 (110)	In net section originating at side of hole
2.3 Base metal at the net section of other mechanically fastened joints except eye bars and pin plates.	D	22×10^8	7 (48)	In net section originating at side of hole
2.4 Base metal at net section of <i>eyebars</i> head or pin plate.	E	11×10^8	4.5 (31)	In net section originating at side of hole

**TABLE A-3.1 (continued)
Fatigue Design Parameters**

Illustrative Typical Examples

SECTION 1 – PLAIN MATERIAL AWAY FROM ANY WELDING

1.1 and 1.2

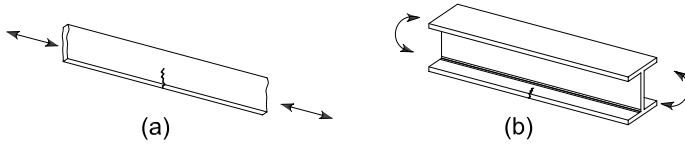

1.3

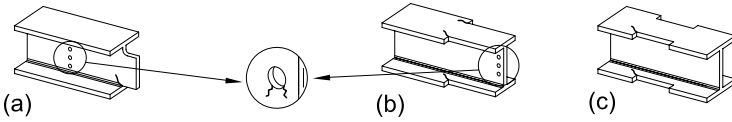

1.4

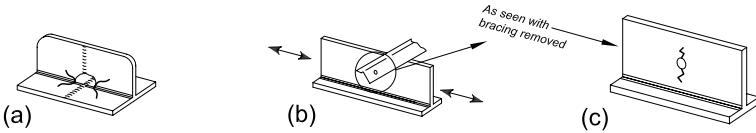

SECTION 2 – CONNECTED MATERIAL IN MECHANICALLY FASTENED JOINTS

2.1

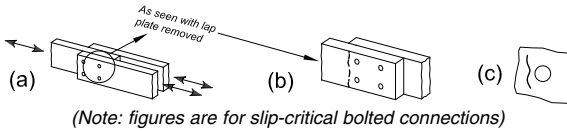

2.2

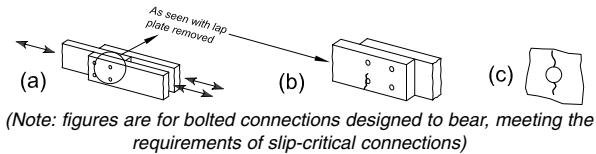

2.3

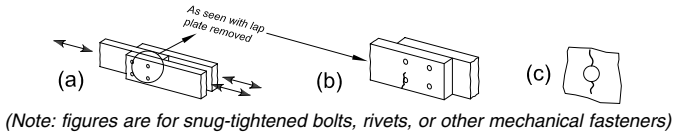

2.4

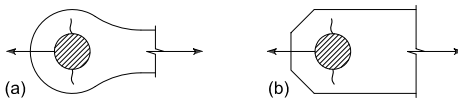

TABLE A-3.1 (continued)
Fatigue Design Parameters

Description	Stress Category	Constant C_f	Threshold F_{TH} ksi (MPa)	Potential Crack Initiation Point
SECTION 3 – WELDED JOINTS JOINING COMPONENTS OF BUILT-UP MEMBERS				
3.1 Base metal and weld metal in members without attachments built up of plates or shapes connected by continuous longitudinal complete-joint-penetration groove welds, back gouged and welded from second side, or by continuous fillet welds.	B	120×10^8	16 (110)	From surface or internal discontinuities in weld away from end of weld
3.2 Base metal and weld metal in members without attachments built up of plates or shapes, connected by continuous longitudinal complete-joint-penetration groove welds with backing bars not removed, or by continuous partial-joint-penetration groove welds.	B'	61×10^8	12 (83)	From surface or internal discontinuities in weld, including weld attaching backing bars
3.3 Base metal at weld metal terminations of longitudinal welds at weld access holes in connected built-up members.	D	22×10^8	7 (48)	From the weld termination into the web or flange
3.4 Base metal at ends of longitudinal intermittent fillet weld segments.	E	11×10^8	4.5 (31)	In connected material at start and stop locations of any weld deposit
3.5 Base metal at ends of partial length welded coverplates narrower than the flange having square or tapered ends, with or without welds across the ends; and coverplates wider than the flange with welds across the ends. Flange thickness (t_f) \leq 0.8 in. (20 mm)	E	11×10^8	4.5 (31)	In flange at toe of end weld or in flange at termination of longitudinal weld or in edge of flange with wide coverplates
Flange thickness (t_f) $>$ 0.8 in. (20 mm)	E'	3.9×10^8	2.6 (18)	
3.6 Base metal at ends of partial length welded coverplates wider than the flange without welds across the ends.	E'	3.9×10^8	2.6 (18)	In edge of flange at end of coverplate weld
SECTION 4 – LONGITUDINAL FILLET WELDED END CONNECTIONS				
4.1 Base metal at junction of axially loaded members with longitudinally welded end connections. Welds shall be on each side of the axis of the member to balance weld stresses. $t \leq$ 0.5 in. (12 mm)	E	11×10^8	4.5 (31)	Initiating from end of any weld termination extending into the base metal
$t >$ 0.5 in. (12 mm)	E'	3.9×10^8	2.6 (18)	

**TABLE A-3.1 (continued)
Fatigue Design Parameters**

Illustrative Typical Examples

SECTION 3 – WELDED JOINTS JOINING COMPONENTS OF BUILT-UP MEMBERS

3.1

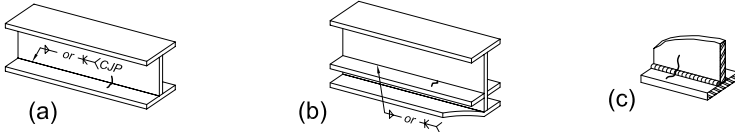

3.2

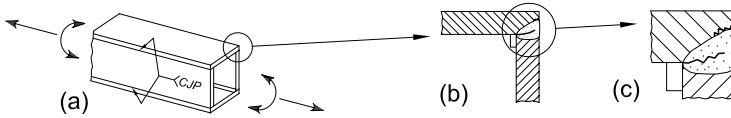

3.3



3.4

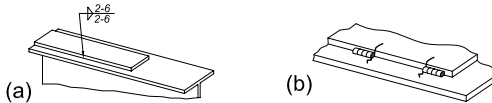

3.5

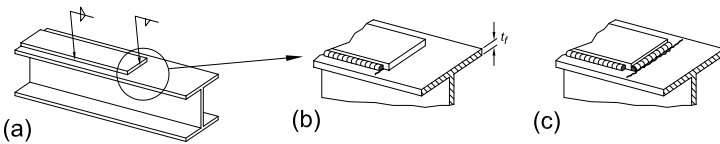

3.6

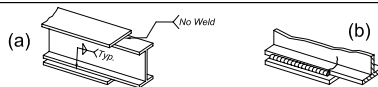

SECTION 4 – LONGITUDINAL FILLET WELDED END CONNECTIONS

4.1

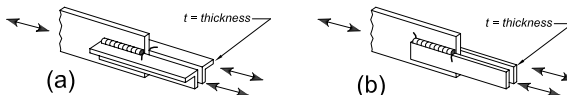

TABLE A-3.1 (continued)
Fatigue Design Parameters

Description	Stress Category	Constant C_f	Threshold F_{TH} ksi (MPa)	Potential Crack Initiation Point
SECTION 5 – WELDED JOINTS TRANSVERSE TO DIRECTION OF STRESS				
5.1 Weld metal and base metal in or adjacent to complete-joint-penetration groove welded splices in rolled or welded cross sections with welds ground essentially parallel to the direction of stress and with soundness established by radiographic or ultrasonic inspection in accordance with the requirements of subclauses 6.12 or 6.13 of AWS D1.1/D1.1M.	B	120×10^8	16 (110)	From internal discontinuities in weld metal or along the fusion boundary
5.2 Weld metal and base metal in or adjacent to complete-joint-penetration groove welded splices with welds ground essentially parallel to the direction of stress at transitions in thickness or width made on a slope no greater than 1:2 ^{1/2} and with weld soundness established by radiographic or ultrasonic inspection in accordance with the requirements of subclauses 6.12 or 6.13 of AWS D1.1/D1.1M. $F_y < 90$ ksi (620 MPa)	B	120×10^8	16 (110)	From internal discontinuities in filler metal or along fusion boundary or at start of transition when $F_y \geq 90$ ksi (620 MPa)
$F_y \geq 90$ ksi (620 MPa)	B'	61×10^8	12 (83)	
5.3 Base metal with F_y equal to or greater than 90 ksi (620 MPa) and weld metal in or adjacent to complete-joint-penetration groove welded splices with welds ground essentially parallel to the direction of stress at transitions in width made on a radius of not less than 2 ft (600 mm) with the point of tangency at the end of the groove weld and with weld soundness established by radiographic or ultrasonic inspection in accordance with the requirements of subclauses 6.12 or 6.13 of AWS D1.1/D1.1M.	B	120×10^8	16 (110)	From internal discontinuities in filler metal or discontinuities along the fusion boundary
5.4 Weld metal and base metal in or adjacent to the toe of complete-joint-penetration groove welds in T or corner joints or splices, with or without transitions in thickness having slopes no greater than 1:2 ^{1/2} , when weld reinforcement is not removed and with weld soundness established by radiographic or ultrasonic inspection in accordance with the requirements of subclauses 6.12 or 6.13 of AWS D1.1/D1.1M.	C	44×10^8	10 (69)	From surface discontinuity at toe of weld extending into base metal or into weld metal.

TABLE A-3.1 (continued)
Fatigue Design Parameters

Illustrative Typical Examples

SECTION 5 – WELDED JOINTS TRANSVERSE TO DIRECTION OF STRESS

5.1

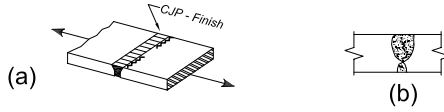

5.2

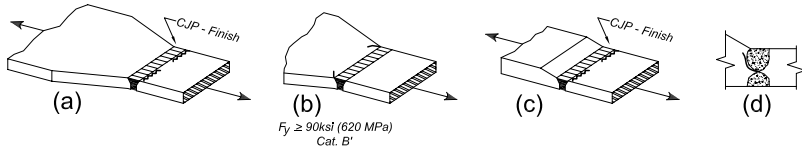

5.3

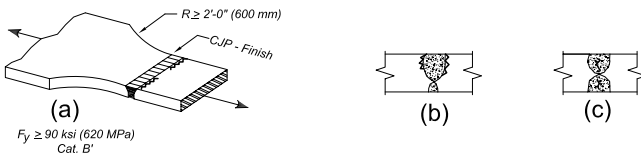

5.4

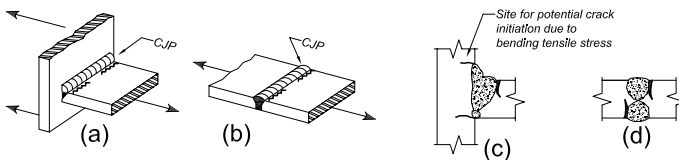

TABLE A-3.1 (continued)
Fatigue Design Parameters

Description	Stress Category	Constant C_f	Threshold F_{TH} ksi (MPa)	Potential Crack Initiation Point
SECTION 5 – WELDED JOINTS TRANSVERSE TO DIRECTION OF STRESS (continued)				
5.5 Base metal and weld metal at transverse end connections of tension-loaded plate elements using partial-joint-penetration groove welds in butt or T- or corner joints, with reinforcing or contouring fillets, F_{SR} shall be the smaller of the toe crack or root crack allowable stress range. Crack initiating from weld toe:	C	44×10^8	10 (69)	Initiating from geometrical discontinuity at toe of weld extending into base metal.
Crack initiating from weld root:	C'	Eqn. A-3-4 or A-3-4M	None provided	Initiating at weld root subject to tension extending into and through weld
5.6 Base metal and weld metal at transverse end connections of tension-loaded plate elements using a pair of fillet welds on opposite sides of the plate. F_{SR} shall be the smaller of the toe crack or root crack allowable stress range. Crack initiating from weld toe:	C	44×10^8	10 (69)	Initiating from geometrical discontinuity at toe of weld extending into base metal.
Crack initiating from weld root:	C''	Eqn. A-3-6 or A-3-6M	None provided	Initiating at weld root subject to tension extending into and through weld
5.7 Base metal of tension loaded plate elements and on girders and rolled beam webs or flanges at toe of transverse fillet welds adjacent to welded transverse stiffeners.	C	44×10^8	10 (69)	From geometrical discontinuity at toe of fillet extending into base metal

TABLE A-3.1 (continued)
Fatigue Design Parameters

Illustrative Typical Examples

SECTION 5 – WELDED JOINTS TRANSVERSE TO DIRECTION OF STRESS

5.5

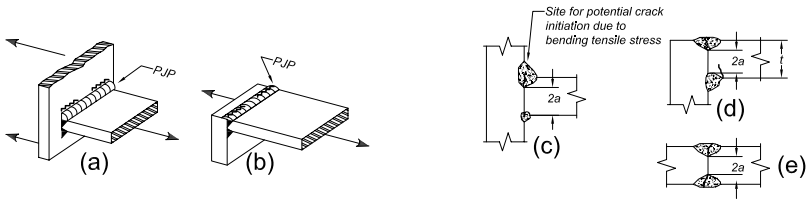

5.6

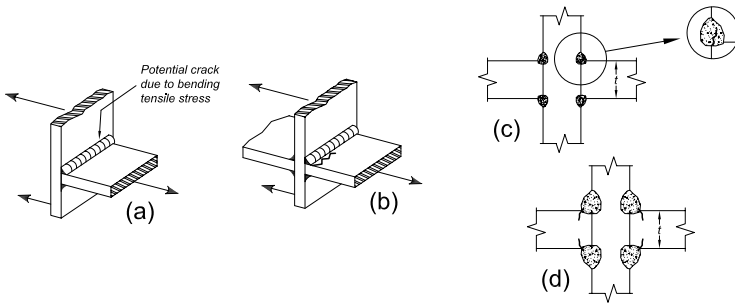

5.7

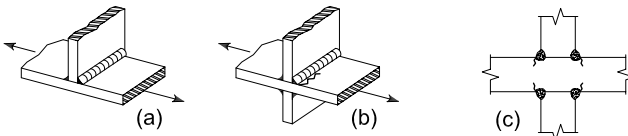

**TABLE A-3.1 (continued)
Fatigue Design Parameters**

Description	Stress Category	Constant C_f	Threshold F_{TH} ksi (MPa)	Potential Crack Initiation Point
SECTION 6 – BASE METAL AT WELDED TRANSVERSE MEMBER CONNECTIONS				
<p>6.1 Base metal at details attached by complete-joint-penetration groove welds subject to longitudinal loading only when the detail embodies a transition radius, R, with the weld termination ground smooth and with weld soundness established by radiographic or ultrasonic inspection in accordance with the requirements of subclauses 6.12 or 6.13 of AWS D1.1/D1.1M. $R \geq 24$ in. (600 mm)</p> <p>24 in. $> R \geq 6$ in. (600 mm $> R \geq 150$ mm)</p> <p>6 in. $> R \geq 2$ in. (150 mm $> R \geq 50$ mm)</p> <p>2 in. (50 mm) $> R$</p>	<p>B</p> <p>C</p> <p>D</p> <p>E</p>	<p>120×10^8</p> <p>44×10^8</p> <p>22×10^8</p> <p>11×10^8</p>	<p>16 (110)</p> <p>10 (69)</p> <p>7 (48)</p> <p>4.5 (31)</p>	<p>Near point of tangency of radius at edge of member</p>
<p>6.2 Base metal at details of equal thickness attached by complete-joint-penetration groove welds subject to transverse loading with or without longitudinal loading when the detail embodies a transition radius, R, with the weld termination ground smooth and with weld soundness established by radiographic or ultrasonic inspection in accordance with the requirements of subclauses 6.12 or 6.13 of AWS D1.1/D1.1M:</p> <p>When weld reinforcement is removed: $R \geq 24$ in. (600 mm)</p> <p>24 in. $> R \geq 6$ in. (600 mm $> R \geq 150$ mm)</p> <p>6 in. $> R \geq 2$ in. (150 mm $> R \geq 50$ mm)</p> <p>2 in. (50 mm) $> R$</p> <p>When weld reinforcement is not removed: $R \geq 24$ in. (600 mm)</p> <p>24 in. $> R \geq 6$ in. (600 mm $> R \geq 150$ mm)</p> <p>6 in. $> R \geq 2$ in. (150 mm $> R \geq 50$ mm)</p> <p>2 in. (50 mm) $> R$</p>	<p>B</p> <p>C</p> <p>D</p> <p>E</p> <p>C</p> <p>C</p> <p>D</p> <p>E</p>	<p>120×10^8</p> <p>44×10^8</p> <p>22×10^8</p> <p>11×10^8</p> <p>44×10^8</p> <p>44×10^8</p> <p>22×10^8</p> <p>11×10^8</p>	<p>16 (110)</p> <p>10 (69)</p> <p>7 (48)</p> <p>4.5 (31)</p> <p>10 (69)</p> <p>10 (69)</p> <p>7 (48)</p> <p>4.5 (31)</p>	<p>Near points of tangency of radius or in the weld or at fusion boundary or member or attachment</p> <p>At toe of the weld either along edge of member or the attachment</p>

TABLE A-3.1 (continued)
Fatigue Design Parameters

Illustrative Typical Examples

SECTION 6 – BASE METAL AT WELDED TRANSVERSE MEMBER CONNECTIONS

6.1

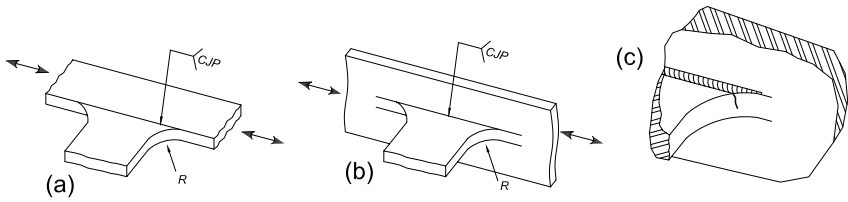

6.2

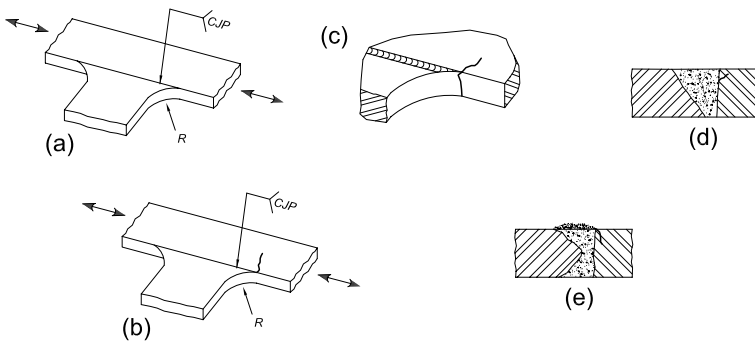

TABLE A-3.1 (continued)
Fatigue Design Parameters

Description	Stress Category	Constant C_f	Threshold F_{TH} ksi (MPa)	Potential Crack Initiation Point
SECTION 6 – BASE METAL AT WELDED TRANSVERSE MEMBER CONNECTIONS (cont'd)				
<p>6.3 Base metal at details of unequal thickness attached by complete-joint-penetration groove welds subject to transverse loading with or without longitudinal loading when the detail embodies a transition radius, R, with the weld termination ground smooth and with weld soundness established by radiographic or ultrasonic inspection in accordance with the requirements of subclauses 6.12 or 6.13 of AWS D1.1/D1.1M.</p> <p>When weld reinforcement is removed: $R > 2$ in. (50 mm)</p> <p>$R \leq 2$ in. (50 mm)</p> <p>When reinforcement is not removed: Any radius</p>	D	22×10^8	7 (48)	At toe of weld along edge of thinner material
	E	11×10^8	4.5 (31)	In weld termination in small radius
	E	11×10^8	4.5 (31)	At toe of weld along edge of thinner material
<p>6.4 Base metal subject to longitudinal stress at transverse members, with or without transverse stress, attached by fillet or partial-joint-penetration groove welds parallel to direction of stress when the detail embodies a transition radius, R, with weld termination ground smooth:</p> <p>$R > 2$ in. (50 mm)</p> <p>$R \leq 2$ in. (50 mm)</p>	D	22×10^8	7 (48)	Initiating in base metal at the weld termination or at the toe of the weld extending into the base metal
	E	11×10^8	4.5 (31)	

TABLE A-3.1 (continued)
Fatigue Design Parameters

Illustrative Typical Examples

SECTION 6 – BASE METAL AT WELDED TRANSVERSE MEMBER CONNECTIONS (cont'd)

6.3

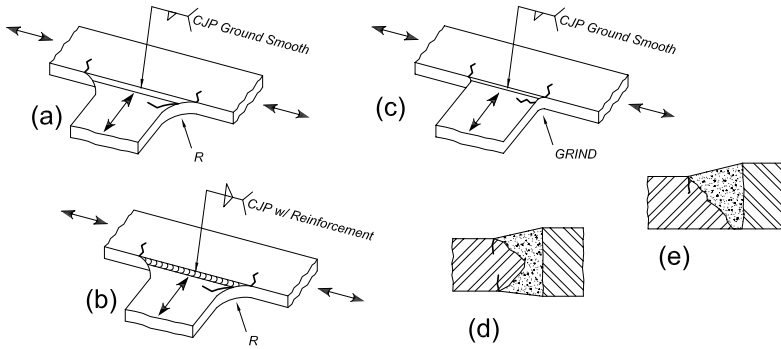

6.4

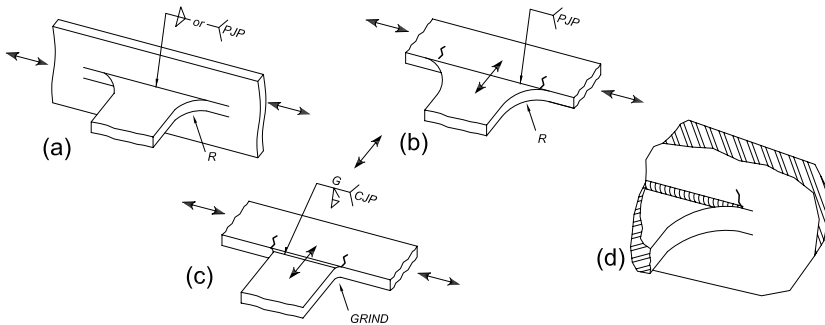

TABLE A-3.1 (continued)
Fatigue Design Parameters

Description	Stress Category	Constant C_f	Threshold F_{TH} ksi (MPa)	Potential Crack Initiation Point
SECTION 7 – BASE METAL AT SHORT ATTACHMENTS¹				
7.1 Base metal subject to longitudinal loading at details with welds parallel or transverse to the direction of stress where the detail embodies no transition radius and with detail length in direction of stress, a , and thickness of the attachment, b : $a < 2$ in. (50 mm)	C	44×10^8	10 (69)	Initiating in base metal at the weld termination or at the toe of the weld extending into the base metal
2 in. (50 mm) $\leq a \leq$ lesser of $12b$ or 4 in. (100 mm)	D	22×10^8	7 (48)	
$a > 4$ in. (100 mm) when $b > 0.8$ in. (20 mm)	E	11×10^8	4.5 (31)	
$a >$ lesser of $12b$ or 4 in. (100 mm) when $b \leq 0.8$ in. (20 mm)	E'	3.9×10^8	2.6 (18)	
7.2 Base metal subject to longitudinal stress at details attached by fillet or partial-joint-penetration groove welds, with or without transverse load on detail, when the detail embodies a transition radius, R , with weld termination ground smooth:				Initiating in base metal at the weld termination, extending into the base metal
$R > 2$ in. (50 mm)	D	22×10^8	7 (48)	
$R \leq 2$ in. (50 mm)	E	11×10^8	4.5 (31)	
¹ "Attachment" as used herein is defined as any steel detail welded to a member which, by its mere presence and independent of its loading, causes a discontinuity in the stress flow in the member and thus reduces the fatigue resistance.				

TABLE A-3.1 (continued)
Fatigue Design Parameters

Illustrative Typical Examples

SECTION 7 – BASE METAL AT SHORT ATTACHMENTS¹

7.1

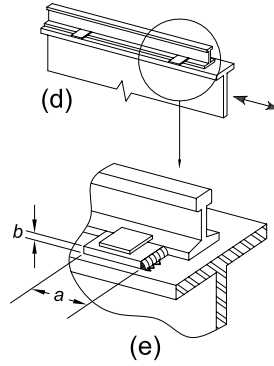
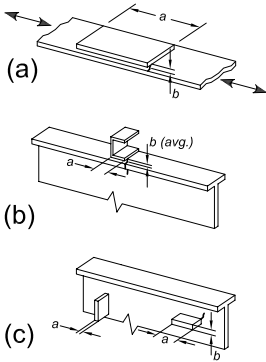

7.2

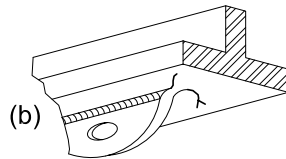
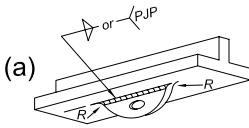

TABLE A-3.1 (continued)
Fatigue Design Parameters

Description	Stress Category	Constant C_f	Threshold F_{TH} ksi (MPa)	Potential Crack Initiation Point
SECTION 8 - MISCELLANEOUS				
8.1 Base metal at steel headed stud anchors attached by fillet or automatic stud welding.	C	44×10^8	10 (69)	At toe of weld in base metal
8.2 Shear on throat of continuous or intermittent longitudinal or transverse fillet welds.	F	150×10^{10} (Eqn. A-3-2 or A-3-2M)	8 (55)	Initiating at the root of the fillet weld, extending into the weld
8.3 Base metal at plug or slot welds.	E	11×10^8	4.5 (31)	Initiating in the base metal at the end of the plug or slot weld, extending into the base metal
8.4 Shear on plug or slot welds.	F	150×10^{10} (Eqn. A-3-2 or A-3-2M)	8 (55)	Initiating in the weld at the faying surface, extending into the weld
8.5 Snug-tightened high-strength bolts, common bolts, threaded anchor rods, and hanger rods with cut, ground or rolled threads. Stress range on tensile stress area due to live load plus prying action when applicable.	G	3.9×10^8	7 (48)	Initiating at the root of the threads, extending into the fastener

**TABLE A-3.1 (continued)
Fatigue Design Parameters**

Illustrative Typical Examples

SECTION 8 - MISCELLANEOUS

8.1



8.2

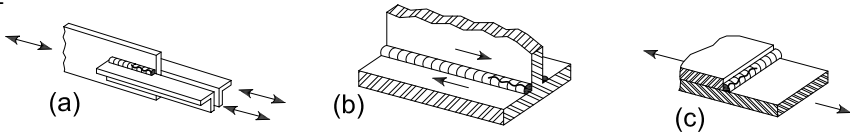

8.3



8.4

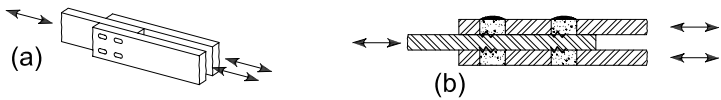

8.5

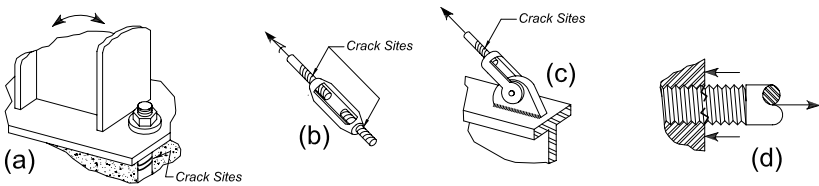

APPENDIX 4

STRUCTURAL DESIGN FOR FIRE CONDITIONS

This appendix provides criteria for the design and evaluation of *structural steel* components, systems and frames for *fire* conditions. These criteria provide for the determination of the heat input, thermal expansion and degradation in mechanical properties of materials at *elevated temperatures* that cause progressive decrease in strength and *stiffness* of *structural components* and systems at elevated temperatures.

The appendix is organized as follows:

- 4.1. General Provisions
- 4.2. Structural Design for Fire Conditions by Analysis
- 4.3. Design by Qualification Testing

4.1. GENERAL PROVISIONS

The methods contained in this appendix provide regulatory evidence of compliance in accordance with the design applications outlined in this section.

4.1.1. Performance Objective

Structural components, members and building frame systems shall be designed so as to maintain their *load-bearing* function during the *design-basis fire* and to satisfy other performance requirements specified for the building occupancy.

Deformation criteria shall be applied where the means of providing structural *fire resistance*, or the design criteria for *fire barriers*, requires consideration of the deformation of the load-carrying structure.

Within the compartment of *fire* origin, *forces* and deformations from the design-basis fire shall not cause a breach of horizontal or vertical *compartmentation*.

4.1.2. Design by Engineering Analysis

The analysis methods in Section 4.2 are permitted to be used to document the anticipated performance of steel framing when subjected to *design-basis fire* scenarios. Methods in Section 4.2 provide evidence of compliance with performance objectives established in Section 4.1.1.

The analysis methods in Section 4.2 are permitted to be used to demonstrate an equivalency for an alternative material or method, as permitted by the *applicable building code*.

Structural design for *fire* conditions using Appendix 4.2 shall be performed using the *load and resistance factor design* method in accordance with the provisions of Section B3.3 (LRFD).

4.1.3. Design by Qualification Testing

The qualification testing methods in Section 4.3 are permitted to be used to document the *fire resistance* of steel framing subject to the standardized *fire* testing protocols required by the *applicable building code*.

4.1.4. Load Combinations and Required Strength

The *required strength* of the structure and its elements shall be determined from the *gravity load combination* as follows:

$$[0.9 \text{ or } 1.2] D + T + 0.5L + 0.2S \quad (\text{A-4-1})$$

where

D = nominal dead load

L = nominal occupancy live load

S = nominal snow load

T = nominal forces and deformations due to the *design-basis fire* defined in Section 4.2.1

A *notional load*, $N_i = 0.002Y_i$, as defined in Section C2.2, where N_i = notional load applied at framing level i and Y_i = gravity load from combination A-4-1 acting on framing level i , shall be applied in combination with the *loads* stipulated in Equation A-4-1. Unless otherwise stipulated by the *applicable building code*, D , L and S shall be the *nominal loads* specified in ASCE/SEI 7.

4.2. STRUCTURAL DESIGN FOR FIRE CONDITIONS BY ANALYSIS

It is permitted to design structural members, components and building frames for *elevated temperatures* in accordance with the requirements of this section.

4.2.1. Design-Basis Fire

A *design-basis fire* shall be identified to describe the heating conditions for the structure. These heating conditions shall relate to the fuel commodities and compartment characteristics present in the assumed *fire* area. The fuel *load density* based on the occupancy of the space shall be considered when determining the total fuel load. Heating conditions shall be specified either in terms of a *heat flux* or temperature of the upper gas layer created by the fire. The variation of the heating conditions with time shall be determined for the duration of the fire.

When the analysis methods in Section 4.2 are used to demonstrate an equivalency as an alternative material or method as permitted by the *applicable building code*, the design-basis fire shall be determined in accordance with ASTM E119.

4.2.1.1. Localized Fire

Where the *heat release rate* from the *fire* is insufficient to cause *flashover*, a localized fire exposure shall be assumed. In such cases, the fuel composition, arrangement of the fuel array and floor area occupied by the fuel shall be used to determine the radiant heat flux from the flame and smoke plume to the structure.

4.2.1.2. Post-Flashover Compartment Fires

Where the heat release rate from the *fire* is sufficient to cause *flashover*, a post-flashover compartment fire shall be assumed. The determination of the temperature versus time profile resulting from the fire shall include fuel *load*, ventilation characteristics of the space (natural and mechanical), compartment dimensions and thermal characteristics of the compartment boundary.

The fire duration in a particular area shall be determined by considering the total combustible mass, or fuel load available in the space. In the case of either a localized fire or a post-flashover compartment fire, the fire duration shall be determined as the total combustible mass divided by the mass loss rate.

4.2.1.3. Exterior Fires

The exposure of exterior structure to flames projecting from windows or other wall openings as a result of a post-*flashover* compartment *fire* shall be considered along with the radiation from the interior fire through the opening. The shape and length of the flame projection shall be used along with the distance between the flame and the exterior steelwork to determine the heat flux to the steel. The method identified in Section 4.2.1.2 shall be used for describing the characteristics of the interior compartment fire.

4.2.1.4. Active Fire Protection Systems

The effects of *active fire protection* systems shall be considered when describing the *design-basis fire*.

Where automatic smoke and heat vents are installed in nonsprinklered spaces, the resulting smoke temperature shall be determined from calculation.

4.2.2. Temperatures in Structural Systems under Fire Conditions

Temperatures within structural members, components and frames due to the heating conditions posed by the *design-basis fire* shall be determined by a heat transfer analysis.

4.2.3. Material Strengths at Elevated Temperatures

Material properties at *elevated temperatures* shall be determined from test data. In the absence of such data, it is permitted to use the material properties stipulated in this section. These relationships do not apply for steels with *yield strengths* in excess of 65 ksi (448 MPa) or concretes with specified compression strength in excess of 8,000 psi (55 MPa).

4.2.3.1. Thermal Elongation

The coefficients of expansion shall be taken as follows:

- (a) For structural and reinforcing steels: For calculations at temperatures above 150 °F (65 °C), the coefficient of thermal expansion shall be $7.8 \times 10^{-6}/^{\circ}\text{F}$ ($1.4 \times 10^{-5}/^{\circ}\text{C}$).

TABLE A-4.2.1
Properties of Steel at Elevated
Temperatures

Steel Temperature, °F (°C)	$k_E = E(T)/E$ $= G(T)/G$	$k_p = F_p(T)/F_y$	$k_y = F_y(T)/F_y$	$k_u = F_u(T)/F_y$
68 (20)	1.00	1.00	1.00	1.00
200 (93)	1.00	1.00	1.00	1.00
400 (204)	0.90	0.80	1.00	1.00
600 (316)	0.78	0.58	1.00	1.00
750 (399)	0.70	0.42	1.00	1.00
800 (427)	0.67	0.40	0.94	0.94
1000 (538)	0.49	0.29	0.66	0.66
1200 (649)	0.22	0.13	0.35	0.35
1400 (760)	0.11	0.06	0.16	0.16
1600 (871)	0.07	0.04	0.07	0.07
1800 (982)	0.05	0.03	0.04	0.04
2000 (1093)	0.02	0.01	0.02	0.02
2200 (1204)	0.00	0.00	0.00	0.00

(b) For normal weight concrete: For calculations at temperatures above 150 °F (65 °C), the coefficient of thermal expansion shall be $1.0 \times 10^{-5}/^\circ\text{F}$ ($1.8 \times 10^{-5}/^\circ\text{C}$).

(c) For *lightweight concrete*: For calculations at temperatures above 150 °F (65 °C), the coefficient of thermal expansion shall be $4.4 \times 10^{-6}/^\circ\text{F}$ ($7.9 \times 10^{-6}/^\circ\text{C}$).

4.2.3.2. Mechanical Properties at Elevated Temperatures

The deterioration in strength and *stiffness* of structural members, components and systems shall be taken into account in the *structural analysis* of the frame. The values $F_y(T)$, $F_p(T)$, $F_u(T)$, $E(T)$, $G(T)$, $f'_c(T)$, $E_c(T)$ and $\epsilon_{cu}(T)$ at elevated temperature to be used in structural analysis, expressed as the ratio with respect to the property at ambient, assumed to be 68 °F (20 °C), shall be defined as in Tables A-4.2.1 and A-4.2.2. $F_p(T)$ is the proportional limit at *elevated temperatures*, which is calculated as a ratio to *yield strength* as specified in Table A-4.2.1. It is permitted to interpolate between these values.

For *lightweight concrete*, values of ϵ_{cu} shall be obtained from tests.

TABLE A-4.2.2
Properties of Concrete at Elevated Temperatures

Concrete Temperature °F (°C)	$k_c = f'_c(T)/f'_c$		$E_c(T)/E_c$	$\varepsilon_{cu}(T)$, % Normal weight concrete
	Normal weight concrete	Lightweight concrete		
68 (20)	1.00	1.00	1.00	0.25
200 (93)	0.95	1.00	0.93	0.34
400 (204)	0.90	1.00	0.75	0.46
550 (288)	0.86	1.00	0.61	0.58
600 (316)	0.83	0.98	0.57	0.62
800 (427)	0.71	0.85	0.38	0.80
1000 (538)	0.54	0.71	0.20	1.06
1200 (649)	0.38	0.58	0.092	1.32
1400 (760)	0.21	0.45	0.073	1.43
1600 (871)	0.10	0.31	0.055	1.49
1800 (982)	0.05	0.18	0.036	1.50
2000 (1093)	0.01	0.05	0.018	1.50
2200 (1204)	0.00	0.00	0.000	0.00

4.2.4. Structural Design Requirements

4.2.4.1. General Structural Integrity

The structural frame shall be capable of providing adequate strength and deformation capacity to withstand, as a system, the structural actions developed during the *fire* within the prescribed limits of deformation. The *structural system* shall be designed to sustain local damage with the structural system as a whole remaining stable.

Continuous *load* paths shall be provided to transfer all *forces* from the exposed region to the final point of resistance. The foundation shall be designed to resist the forces and to accommodate the deformations developed during the *design-basis fire*.

4.2.4.2. Strength Requirements and Deformation Limits

Conformance of the *structural system* to these requirements shall be demonstrated by constructing a mathematical model of the structure based on principles of structural mechanics and evaluating this model for the internal forces and deformations in the members of the structure developed by the temperatures from the *design-basis fire*.

Individual members shall be provided with adequate strength to resist the shears, axial forces and moments determined in accordance with these provisions.

Connections shall develop the strength of the connected members or the forces indicated above. Where the means of providing *fire resistance* requires the consideration of deformation criteria, the deformation of the structural system, or members thereof, under the design-basis fire shall not exceed the prescribed limits.

4.2.4.3. Methods of Analysis

4.2.4.3a. Advanced Methods of Analysis

The methods of analysis in this section are permitted for the design of all steel building structures for *fire* conditions. The *design-basis fire* exposure shall be that determined in Section 4.2.1. The analysis shall include both a thermal response and the mechanical response to the design-basis fire.

The thermal response shall produce a temperature field in each structural element as a result of the design-basis fire and shall incorporate temperature-dependent thermal properties of the structural elements and fire-resistive materials, as per Section 4.2.2.

The mechanical response results in forces and deformations in the *structural system* subjected to the thermal response calculated from the design-basis fire. The mechanical response shall take into account explicitly the deterioration in strength and *stiffness* with increasing temperature, the effects of thermal expansions, and large deformations. Boundary conditions and connection fixity must represent the proposed structural design. Material properties shall be defined as per Section 4.2.3.

The resulting analysis shall consider all relevant *limit states*, such as excessive deflections, connection fractures, and overall or *local buckling*.

4.2.4.3b. Simple Methods of Analysis

The methods of analysis in this section are permitted to be used for the evaluation of the performance of individual members at *elevated temperatures* during exposure to *fire*.

The support and restraint conditions (forces, moments and boundary conditions) applicable at normal temperatures are permitted to be assumed to remain unchanged throughout the fire exposure.

For steel temperatures less than or equal to 400 °F (204 °C), the member and connection *design strengths* shall be determined without consideration of temperature effects.

User Note: At temperatures below 400 °F (204 °C), the degradation in steel properties need not be considered in calculating member strengths for the simple method of analysis; however, forces and deformations induced by elevated temperatures must be considered.

(1) Tension Members

It is permitted to model the thermal response of a tension element using a one-dimensional heat transfer equation with heat input as determined by the *design-basis fire* defined in Section 4.2.1.

The design strength of a tension member shall be determined using the provisions of Chapter D, with steel properties as stipulated in Section 4.2.3 and assuming a uniform temperature over the cross section using the temperature equal to the maximum steel temperature.

(2) Compression Members

It is permitted to model the thermal response of a compression element using a one-dimensional heat transfer equation with heat input as determined by the *design-basis fire* defined in Section 4.2.1.

The design strength of a compression member shall be determined using the provisions of Chapter E with steel properties as stipulated in Section 4.2.3 and Equation A-4-2 used in lieu of Equations E3-2 and E3-3 to calculate the nominal compressive strength for *flexural buckling*:

$$F_{cr}(T) = \left[0.42 \sqrt{\frac{F_y(T)}{E_c(T)}} \right] F_y(T) \quad (\text{A-4-2})$$

where $F_y(T)$ is the *yield stress* at elevated temperature and $F_c(T)$ is the critical elastic buckling stress calculated from Equation E3-4 with the elastic modulus $E(T)$ at elevated temperature. $F_y(T)$ and $E(T)$ are obtained using coefficients from Table A-4.2.1.

(3) Flexural Members

It is permitted to model the thermal response of flexural elements using a one-dimensional heat transfer equation to calculate bottom flange temperature and to assume that this bottom flange temperature is constant over the depth of the member.

The design strength of a flexural member shall be determined using the provisions of Chapter F with steel properties as stipulated in Section 4.2.3 and Equations A-4-3 through A-4-10 used in lieu of Equations F2-2 through F2-6 to calculate the nominal flexural strength for *lateral-torsional buckling* of laterally unbraced doubly symmetric members:

(a) When $L_b \leq L_r(T)$

$$M_n(T) = C_b \left[M_r(T) + [M_p(T) - M_r(T)] \left[1 - \frac{L_b}{L_r(T)} \right]^{c_x} \right] \quad (\text{A-4-3})$$

(b) When $L_b > L_r(T)$

$$M_n(T) = F_{cr}(T) S_x \quad (\text{A-4-4})$$

where

$$F_{cr}(T) = \frac{C_b \pi^2 E(T)}{\left(\frac{L_b}{r_{ts}}\right)^2} \sqrt{1 + 0.078 \frac{Jc}{S_x h_o} \left(\frac{L_b}{r_{ts}}\right)^2} \quad (\text{A-4-5})$$

$$L_r(T) = 1.95 r_{ts} \frac{E(T)}{F_L(T)} \sqrt{\frac{Jc}{S_x h_o} + \sqrt{\left(\frac{Jc}{S_x h_o}\right)^2 + 6.76 \left[\frac{F_L(T)}{E(T)}\right]^2}} \quad (\text{A-4-6})$$

$$M_r(T) = S_x F_L(T) \quad (\text{A-4-7})$$

$$F_L(T) = F_y (k_p - 0.3k_y) \quad (\text{A-4-8})$$

$$M_p(T) = Z_x F_y(T) \quad (\text{A-4-9})$$

$$c_x = 0.53 + \frac{T}{450} \leq 3.0 \text{ where } T \text{ is in } ^\circ\text{F} \quad (\text{A-4-10})$$

$$c_x = 0.6 + \frac{T}{250} \leq 3.0 \text{ where } T \text{ is in } ^\circ\text{C} \quad (\text{S.I.}) \quad (\text{A-4-10M})$$

The material properties at elevated temperatures, $E(T)$ and $F_y(T)$, and the k_p and k_y coefficients are calculated in accordance with Table A-4.2.1, and other terms are as defined in Chapter F.

(4) Composite Floor Members

It is permitted to model the thermal response of flexural elements supporting a concrete slab using a one-dimensional heat transfer equation to calculate bottom flange temperature. That temperature shall be taken as constant between the bottom flange and mid-depth of the web and shall decrease linearly by no more than 25% from the mid-depth of the web to the top flange of the *beam*.

The design strength of a *composite* flexural member shall be determined using the provisions of Chapter I, with reduced yield stresses in the steel consistent with the temperature variation described under thermal response.

4.2.4.4. Design Strength

The design strength shall be determined as in Section B3.3. The *nominal strength*, R_n , shall be calculated using material properties, as provided in Section 4.2.3, at the temperature developed by the *design-basis fire*, and as stipulated in this appendix.

4.3. DESIGN BY QUALIFICATION TESTING

4.3.1. Qualification Standards

Structural members and components in steel buildings shall be qualified for the rating period in conformance with ASTM E119. Demonstration of compliance

with these requirements using the procedures specified for steel construction in Section 5 of SEI/ASCE/SFPE Standard 29-05, *Standard Calculation Methods for Structural Fire Protection*, is permitted.

4.3.2. Restrained Construction

For floor and roof assemblies and individual *beams* in buildings, a restrained condition exists when the surrounding or supporting structure is capable of resisting forces and accommodating deformations caused by thermal expansion throughout the range of anticipated *elevated temperatures*.

Steel beams, girders and frames supporting concrete slabs that are welded or bolted to integral framing members shall be considered *restrained construction*.

4.3.3. Unrestrained Construction

Steel *beams*, girders and frames that do not support a concrete slab shall be considered unrestrained unless the members are bolted or welded to surrounding construction that has been specifically designed and detailed to resist effects of *elevated temperatures*.

A steel member bearing on a wall in a single span or at the end span of multiple spans shall be considered unrestrained unless the wall has been designed and detailed to resist effects of thermal expansion.

APPENDIX 5

EVALUATION OF EXISTING STRUCTURES

This appendix applies to the evaluation of the strength and *stiffness* under static vertical (gravity) *loads* of existing structures by *structural analysis*, by load tests or by a combination of structural analysis and load tests when specified by the *engineer of record* or in the contract documents. For such evaluation, the steel grades are not limited to those listed in Section A3.1. This appendix does not address load testing for the effects of seismic loads or moving loads (vibrations).

The Appendix is organized as follows:

- 5.1. General Provisions
- 5.2. Material Properties
- 5.3. Evaluation by Structural Analysis
- 5.4. Evaluation by Load Tests
- 5.5. Evaluation Report

5.1. GENERAL PROVISIONS

These provisions shall be applicable when the evaluation of an existing steel structure is specified for (a) verification of a specific set of design loadings or (b) determination of the *available strength* of a *force* resisting member or system. The evaluation shall be performed by *structural analysis* (Section 5.3), by *load tests* (Section 5.4), or by a combination of structural analysis and load tests, as specified in the contract documents. Where load tests are used, the *engineer of record* shall first analyze the applicable parts of the structure, prepare a testing plan, and develop a written procedure to prevent excessive permanent deformation or catastrophic collapse during testing.

5.2. MATERIAL PROPERTIES

1. Determination of Required Tests

The *engineer of record* shall determine the specific tests that are required from Sections 5.2.2 through 5.2.6 and specify the locations where they are required. Where available, the use of applicable project records shall be permitted to reduce or eliminate the need for testing.

2. Tensile Properties

Tensile properties of members shall be considered in evaluation by *structural analysis* (Section 5.3) or *load tests* (Section 5.4). Such properties shall include the *yield stress*, *tensile strength* and *percent elongation*. Where available, certified material test reports or certified reports of tests made by the fabricator or a testing laboratory in accordance with ASTM A6/A6M or A568/A568M, as applicable, shall be permit-

ted for this purpose. Otherwise, tensile tests shall be conducted in accordance with ASTM A370 from samples cut from components of the structure.

3. Chemical Composition

Where welding is anticipated for repair or modification of existing structures, the chemical composition of the steel shall be determined for use in preparing a welding procedure specification (WPS). Where available, results from certified material test reports or certified reports of tests made by the fabricator or a testing laboratory in accordance with ASTM procedures shall be permitted for this purpose. Otherwise, analyses shall be conducted in accordance with ASTM A751 from the samples used to determine tensile properties, or from samples taken from the same locations.

4. Base Metal Notch Toughness

Where welded tension *splices* in heavy shapes and plates as defined in Section A3.1d are critical to the performance of the structure, the Charpy *V-notch toughness* shall be determined in accordance with the provisions of Section A3.1d. If the notch toughness so determined does not meet the provisions of Section A3.1d, the *engineer of record* shall determine if remedial actions are required.

5. Weld Metal

Where structural performance is dependent on existing welded *connections*, representative samples of *weld metal* shall be obtained. Chemical analysis and mechanical tests shall be made to characterize the weld metal. A determination shall be made of the magnitude and consequences of imperfections. If the requirements of AWS D1.1/D1.1M are not met, the *engineer of record* shall determine if remedial actions are required.

6. Bolts and Rivets

Representative samples of bolts shall be inspected to determine markings and classifications. Where bolts cannot be properly identified visually, representative samples shall be removed and tested to determine *tensile strength* in accordance with ASTM F606 or ASTM F606M and the bolt classified accordingly. Alternatively, the assumption that the bolts are ASTM A307 shall be permitted. Rivets shall be assumed to be ASTM A502, Grade 1, unless a higher grade is established through documentation or testing.

5.3. EVALUATION BY STRUCTURAL ANALYSIS

1. Dimensional Data

All dimensions used in the evaluation, such as spans, *column* heights, member spacings, *bracing* locations, cross section dimensions, thicknesses, and *connection* details, shall be determined from a field survey. Alternatively, when available, it shall be permitted to determine such dimensions from applicable project design or shop drawings with field verification of critical values.

2. Strength Evaluation

Forces (load effects) in members and connections shall be determined by *structural analysis* applicable to the type of structure evaluated. The load effects shall be determined for the static vertical (gravity) *loads* and *factored load* combinations stipulated in Section B2.

The *available strength* of members and connections shall be determined from applicable provisions of Chapters B through K of this Specification.

3. Serviceability Evaluation

Where required, the deformations at *service loads* shall be calculated and reported.

5.4. EVALUATION BY LOAD TESTS

1. Determination of Load Rating by Testing

To determine the *load* rating of an existing floor or roof structure by testing, a test load shall be applied incrementally in accordance with the *engineer of record's* plan. The structure shall be visually inspected for signs of distress or imminent failure at each load level. Appropriate measures shall be taken if these or any other unusual conditions are encountered.

The tested strength of the structure shall be taken as the maximum applied test load plus the in-situ dead load. The live load rating of a floor structure shall be determined by setting the tested strength equal to $1.2D + 1.6L$, where D is the nominal dead load and L is the nominal live load rating for the structure. The nominal live load rating of the floor structure shall not exceed that which can be calculated using applicable provisions of the specification. For roof structures, L_r , S or R as defined in ASCE/SEI 7, shall be substituted for L . More severe *load combinations* shall be used where required by *applicable building codes*.

Periodic unloading shall be considered once the *service load* level is attained and after the onset of inelastic structural behavior is identified to document the amount of permanent set and the magnitude of the inelastic deformations. Deformations of the structure, such as member deflections, shall be monitored at critical locations during the test, referenced to the initial position before loading. It shall be demonstrated that the deformation of the structure does not increase by more than 10% during a one-hour holding period under sustained, maximum test load. It is permissible to repeat the sequence if necessary to demonstrate compliance.

Deformations of the structure shall also be recorded 24 hours after the test loading is removed to determine the amount of permanent set. Because the amount of acceptable permanent deformation depends on the specific structure, no limit is specified for permanent deformation at maximum loading. Where it is not feasible to load test the entire structure, a segment or zone of not less than one complete bay, representative of the most critical conditions, shall be selected.

2. Serviceability Evaluation

When *load* tests are prescribed, the structure shall be loaded incrementally to the *service load* level. Deformations shall be monitored during a one hour holding period under sustained service test load. The structure shall then be unloaded and the deformation recorded.

5.5. EVALUATION REPORT

After the evaluation of an existing structure has been completed, the *engineer of record* shall prepare a report documenting the evaluation. The report shall indicate whether the evaluation was performed by *structural analysis*, by *load* testing, or by a combination of structural analysis and load testing. Furthermore, when testing is performed, the report shall include the loads and load combination used and the load-deformation and time-deformation relationships observed. All relevant information obtained from *design drawings*, material test reports, and auxiliary material testing shall also be reported. Finally, the report shall indicate whether the structure, including all members and *connections*, is adequate to withstand the *load effects*.

APPENDIX 6

STABILITY BRACING FOR COLUMNS AND BEAMS

This appendix addresses the minimum strength and *stiffness* necessary to provide a braced point in a *column*, *beam* or *beam-column*.

The appendix is organized as follows:

- 6.1. General Provisions
- 6.2. Column Bracing
- 6.3. Beam Bracing
- 6.4. Beam-Column Bracing

User Note: The *stability* requirements for braced-frame systems are provided in Chapter C. The provisions in this appendix apply to *bracing* that is provided to stabilize individual columns, beams and beam-columns.

6.1. GENERAL PROVISIONS

Columns with end and intermediate braced points designed to meet the requirements in Section 6.2 are permitted to be designed based on the *unbraced length*, L , between the braced points with an *effective length factor*, $K = 1.0$. *Beams* with intermediate braced points designed to meet the requirements in Section 6.3 are permitted to be designed based on the unbraced length, L_b , between the braced points.

When *bracing* is perpendicular to the members to be braced, the equations in Sections 6.2 and 6.3 shall be used directly. When bracing is oriented at an angle to the member to be braced, these equations shall be adjusted for the angle of inclination. The evaluation of the *stiffness* furnished by a brace shall include its member and geometric properties, as well as the effects of *connections* and anchoring details.

User Note: In this appendix, relative and nodal bracing systems are addressed for columns and for beams with *lateral bracing*. For beams with *torsional bracing*, nodal and continuous bracing systems are addressed.

A *relative brace* controls the movement of the braced point with respect to adjacent braced points. A *nodal brace* controls the movement at the braced point without direct interaction with adjacent braced points. A continuous bracing system consists of bracing that is attached along the entire member length; however, nodal bracing systems with a regular spacing can also be modeled as a continuous system.

The *available strength* and stiffness of the bracing members and connections shall equal or exceed the *required strength* and stiffness, respectively, unless analysis indicates that smaller values are justified. A *second-order analysis* that includes the

initial out-of-straightness of the member to obtain brace strength and stiffness requirements is permitted in lieu of the requirements of this appendix.

6.2. COLUMN BRACING

It is permitted to brace an individual *column* at end and intermediate points along the length using either relative or nodal *bracing*.

1. Relative Bracing

The *required strength* is

$$P_{rb} = 0.004P_r \quad (\text{A-6-1})$$

The required *stiffness* is

$$\beta_{br} = \frac{1}{\phi} \left(\frac{2P_r}{L_b} \right) \quad (\text{LRFD}) \quad \beta_{br} = \Omega \left(\frac{2P_r}{L_b} \right) \quad (\text{ASD}) \quad (\text{A-6-2})$$

where

$$\phi = 0.75 \quad (\text{LRFD}) \quad \Omega = 2.00 \quad (\text{ASD})$$

L_b = unbraced length, in. (mm)

For design according to Section B3.3 (LRFD)

P_r = required strength in axial compression using *LRFD load combinations*, kips (N)

For design according to Section B3.4 (ASD)

P_r = required strength in axial compression using *ASD load combinations*, kips (N)

2. Nodal Bracing

The *required strength* is

$$P_{rb} = 0.01P_r \quad (\text{A-6-3})$$

The required *stiffness* is

$$\beta_{br} = \frac{1}{\phi} \left(\frac{8P_r}{L_b} \right) \quad (\text{LRFD}) \quad \beta_{br} = \Omega \left(\frac{8P_r}{L_b} \right) \quad (\text{ASD}) \quad (\text{A-6-4})$$

User Note: These equations correspond to the assumption that *nodal braces* are equally spaced along the *column*.

where

$$\phi = 0.75 \quad (\text{LRFD}) \quad \Omega = 2.00 \quad (\text{ASD})$$

For design according to Section B3.3 (LRFD)

P_r = required strength in axial compression using *LRFD load combinations*, kips (N)

For design according to Section B3.4 (ASD)

P_r = required strength in axial compression using *ASD load combinations*, kips (N)

In Equation A-6-4, L_b need not be taken less than the maximum *effective length, KL*, permitted for the column based upon the required axial strength, P_r .

6.3. BEAM BRACING

Beams and trusses shall be restrained against rotation about their longitudinal axis at points of support. When a braced point is assumed in the design between points of support, *lateral bracing*, *torsional bracing*, or a combination of the two shall be provided to prevent the relative displacement of the top and bottom flanges (i.e., to prevent twist). In members subject to *double curvature* bending, the inflection point shall not be considered a braced point unless *bracing* is provided at that location.

1. Lateral Bracing

Lateral bracing shall be attached at or near the *beam* compression flange, except as follows:

- (1) At the free end of a cantilevered beam, lateral bracing shall be attached at or near the top (tension) flange.
- (2) For braced beams subject to *double curvature* bending, lateral bracing shall be attached to both flanges at the braced point nearest the inflection point.

1a. Relative Bracing

The *required strength* is

$$P_{rb} = 0.008M_r C_d / h_o \quad (\text{A-6-5})$$

The required *stiffness* is

$$\beta_{br} = \frac{1}{\phi} \left(\frac{4M_r C_d}{L_b h_o} \right) \quad (\text{LRFD}) \quad \beta_{br} = \Omega \left(\frac{4M_r C_d}{L_b h_o} \right) \quad (\text{ASD}) \quad (\text{A-6-6})$$

where

$$\phi = 0.75 \quad (\text{LRFD}) \quad \Omega = 2.00 \quad (\text{ASD})$$

$C_d = 1.0$ except in the following case;

= 2.0 for the brace closest to the inflection point in a *beam* subject to *double curvature* bending

h_o = distance between flange centroids, in. (mm)

For design according to Section B3.3 (LRFD)

M_r = required flexural strength using *LRFD load combinations*, kip-in. (N-mm)

For design according to Section B3.4 (ASD)

M_r = required flexural strength using *ASD load combinations*, kip-in. (N-mm)

1b. Nodal Bracing

The required strength is

$$P_{rb} = 0.02M_r C_d / h_o \quad (\text{A-6-7})$$

The required stiffness is

$$\beta_{br} = \frac{1}{\phi} \left(\frac{10M_r C_d}{L_b h_o} \right) \quad (\text{LRFD}) \quad \beta_{br} = \Omega \left(\frac{10M_r C_d}{L_b h_o} \right) \quad (\text{ASD}) \quad (\text{A-6-8})$$

where

$$\phi = 0.75 \quad (\text{LRFD}) \quad \Omega = 2.00 \quad (\text{ASD})$$

For design according to Section B3.3 (LRFD)

M_r = required flexural strength using *LRFD load combinations*, kip-in. (N-mm)

For design according to Section B3.4 (ASD)

M_r = required flexural strength using *ASD load combinations*, kip-in. (N-mm)

In Equation A-6-8, L_b need not be taken less than the maximum *unbraced length* permitted for the *beam* based upon the flexural required strength, M_r .

2. Torsional Bracing

It is permitted to attach *torsional bracing* at any cross-sectional location, and it need not be attached near the compression flange.

User Note: Torsional bracing can be provided with a moment-connected *beam*, cross-frame, or other *diaphragm* element.

2a. Nodal Bracing

The *required strength* is

$$M_{rb} = \frac{0.024M_r L}{nC_b L_b} \quad (\text{A-6-9})$$

The required *stiffness* of the brace is

$$\beta_{Tb} = \frac{\beta_T}{\left(1 - \frac{\beta_T}{\beta_{sec}} \right)} \quad (\text{A-6-10})$$

where

$$\beta_T = \frac{1}{\phi} \left(\frac{2.4LM_r^2}{nEI_y C_b^2} \right) \quad (\text{LRFD}) \quad \beta_T = \Omega \left(\frac{2.4LM_r^2}{nEI_y C_b^2} \right) \quad (\text{ASD}) \quad (\text{A-6-11})$$

$$\beta_{sec} = \frac{3.3E}{h_o} \left(\frac{1.5h_o t_w^3}{12} + \frac{t_{st} b_s^3}{12} \right) \quad (\text{A-6-12})$$

where

$$\phi = 0.75 \text{ (LRFD)} \quad \Omega = 3.00 \text{ (ASD)}$$

User Note: $\Omega = 1.5^2/\phi = 3.00$ in Equation A-6-11 because the moment term is squared.

- C_b = modification factor defined in Chapter F
- E = modulus of elasticity of steel = 29,000 ksi (200 000 MPa)
- I_y = out-of-plane moment of inertia, in.⁴ (mm⁴)
- L = length of span, in. (mm)
- b_s = *stiffener* width for one-sided stiffeners, in. (mm)
= twice the individual stiffener width for pairs of stiffeners, in. (mm)
- n = number of nodal braced points within the span
- t_w = thickness of *beam* web, in. (mm)
- t_{st} = thickness of web stiffener, in. (mm)
- β_T = overall brace system stiffness, kip-in./rad (N-mm/rad)
- β_{sec} = web *distortional stiffness*, including the effect of web *transverse stiffeners*, if any, kip-in./rad (N-mm/rad)

User Note: If $\beta_{sec} < \beta_T$, Equation A-6-10 is negative, which indicates that torsional beam *bracing* will not be effective due to inadequate web distortional stiffness.

For design according to Section B3.3 (LRFD)

M_r = required flexural strength using *LRFD load combinations*, kip-in. (N-mm)

For design according to Section B3.4 (ASD)

M_r = required flexural strength using *ASD load combinations*, kip-in. (N-mm)

When required, the web stiffener shall extend the full depth of the braced member and shall be attached to the flange if the torsional brace is also attached to the flange. Alternatively, it shall be permissible to stop the stiffener short by a distance equal to $4t_w$ from any beam flange that is not directly attached to the torsional brace.

In Equation A-6-9, L_b need not be taken less than the maximum *unbraced length* permitted for the beam based upon the required flexural strength, M_r .

2b. Continuous Bracing

For continuous *bracing*, Equations A-6-9 and A-6-10 shall be used with the following modifications:

- (1) $L/n = 1.0$
- (2) L_b shall be taken equal to the maximum *unbraced length* permitted for the *beam* based upon the required flexural strength, M_r

(3) The web *distortional stiffness* shall be taken as:

$$\beta_{sec} = \frac{3.3Et_w^3}{12h_o} \quad (\text{A-6-13})$$

6.4. BEAM-COLUMN BRACING

For *bracing of beam-columns*, the *required strength* and *stiffness* for the axial force shall be determined as specified in Section 6.2, and the required strength and stiffness for the flexure shall be determined as specified in Section 6.3. The values so determined shall be combined as follows:

- (a) When relative *lateral bracing* is used, the required strength shall be taken as the sum of the values determined using Equations A-6-1 and A-6-5, and the required stiffness shall be taken as the sum of the values determined using Equations A-6-2 and A-6-6.
- (b) When nodal lateral bracing is used, the required strength shall be taken as the sum of the values determined using Equations A-6-3 and A-6-7, and the required stiffness shall be taken as the sum of the values determined using Equations A-6-4 and A-6-8. In Equations A-6-4 and A-6-8, L_b for beam-columns shall be taken as the actual *unbraced length*; the provisions in Sections 6.2.2 and 6.3.1b that L_b need not be taken less than the maximum permitted *effective length* based upon P_r and M_r shall not be applied.
- (c) When *torsional bracing* is provided for flexure in combination with relative or nodal *bracing* for the axial force, the required strength and stiffness shall be combined or distributed in a manner that is consistent with the resistance provided by the element(s) of the actual bracing details.

APPENDIX 7

ALTERNATIVE METHODS OF DESIGN FOR STABILITY

This appendix presents alternatives to the *direct analysis method* of design for *stability* defined in Chapter C. The two alternative methods covered are the *effective length* method and the *first-order analysis* method.

The appendix is organized as follows:

- 7.1. General Stability Requirements
- 7.2. Effective Length Method
- 7.3. First-Order Analysis Method

7.1. GENERAL STABILITY REQUIREMENTS

The general requirements of Section C1 shall apply. As an alternative to the *direct analysis method* (defined in Sections C1 and C2), it is permissible to design structures for *stability* in accordance with either the *effective length* method, specified in Section 7.2, or the *first-order analysis* method, specified in Section 7.3, subject to the limitations indicated in those sections.

7.2. EFFECTIVE LENGTH METHOD

1. Limitations

The use of the *effective length* method shall be limited to the following conditions:

- (1) The structure supports *gravity loads* primarily through nominally vertical *columns*, walls or frames.
- (2) The ratio of maximum second-order *drift* to maximum first-order drift (both determined for *LRFD load combinations* or 1.6 times *ASD load combinations*) in all stories is equal to or less than 1.5.

User Note: The ratio of second-order drift to first-order drift in a story may be taken as the B_2 multiplier, calculated as specified in Appendix 8.

2. Required Strengths

The *required strengths* of components shall be determined from analysis conforming to the requirements of Section C2.1, except that the *stiffness* reduction indicated in Section C2.3 shall not be applied; the nominal stiffnesses of all *structural steel* components shall be used. *Notional loads* shall be applied in the analysis in accordance with Section C2.2b.

User Note: Since the condition specified in Section C2.2b(4) will be satisfied in all cases where the effective length method is applicable, the notional load need only be applied in gravity-only load cases.

3. Available Strengths

The *available strengths* of members and connections shall be calculated in accordance with the provisions of Chapters D, E, F, G, H, I, J and K, as applicable.

The *effective length factor*, K , of members subject to compression shall be taken as specified in (a) or (b), below, as applicable.

- (a) In *braced frame* systems, *shear wall* systems, and other *structural systems* where lateral *stability* and resistance to *lateral loads* does not rely on the flexural *stiffness* of *columns*, the effective length factor, K , of members subject to compression shall be taken as 1.0, unless rational analysis indicates that a lower value is appropriate.
- (b) In *moment frame* systems and other structural systems in which the flexural stiffnesses of columns are considered to contribute to lateral stability and resistance to lateral loads, the effective length factor, K , or elastic critical *buckling* stress, F_e , of those columns whose flexural stiffnesses are considered to contribute to lateral stability and resistance to lateral loads shall be determined from a *side-sway buckling* analysis of the structure; K shall be taken as 1.0 for columns whose flexural stiffnesses are not considered to contribute to lateral stability and resistance to lateral loads.

Exception: It is permitted to use $K = 1.0$ in the design of all columns if the ratio of maximum second-order *drift* to maximum first-order drift (both determined for *LRFD load combinations* or 1.6 times *ASD load combinations*) in all stories is equal to or less than 1.1.

User Note: Methods of calculating the effective length factor, K , are discussed in the *Commentary*.

Bracing intended to define the *unbraced lengths* of members shall have sufficient stiffness and strength to control member movement at the braced points.

User Note: Methods of satisfying the bracing requirement are provided in Appendix 6. The requirements of Appendix 6 are not applicable to bracing that is included in the analysis of the overall structure as part of the overall force-resisting system.

7.3. FIRST-ORDER ANALYSIS METHOD

1. Limitations

The use of the *first-order analysis* method shall be limited to the following conditions:

- (1) The structure supports *gravity loads* primarily through nominally vertical *columns*, walls or frames.
- (2) The ratio of maximum second-order *drift* to maximum first-order drift (both determined for *LRFD load combinations* or 1.6 times *ASD load combinations*) in all stories is equal to or less than 1.5.

User Note: The ratio of second-order drift to first-order drift in a story may be taken as the B_2 multiplier, calculated as specified in Appendix 8.

- (3) The *required axial compressive strengths* of all members whose flexural *stiffnesses* are considered to contribute to the lateral *stability* of the structure satisfy the limitation:

$$\alpha P_r \leq 0.5 P_y \quad (\text{A-7-1})$$

where

$\alpha = 1.0$ (LRFD); $\alpha = 1.6$ (ASD)

P_r = required axial compressive strength under LRFD or ASD load combinations, kips (N)

$P_y = F_y A$ = axial *yield strength*, kips (N)

2. Required Strengths

The *required strengths* of components shall be determined from a *first-order analysis*, with additional requirements (1) and (2) below. The analysis shall consider flexural, shear and axial member deformations, and all other deformations that contribute to displacements of the structure.

- (1) All load combinations shall include an additional *lateral load*, N_i , applied in combination with other loads at each level of the structure:

$$N_i = 2.1\alpha(\Delta/L)Y_i \geq 0.0042Y_i \quad (\text{A-7-2})$$

where

$\alpha = 1.0$ (LRFD); $\alpha = 1.6$ (ASD)

Y_i = *gravity load* applied at level i from the *LRFD load combination* or *ASD load combination*, as applicable, kips (N)

Δ/L = maximum ratio of Δ to L for all stories in the structure

Δ = first-order interstory *drift* due to the LRFD or ASD load combination, as applicable, in. (mm). Where Δ varies over the plan area of the structure, Δ shall be the average drift weighted in proportion to vertical *load* or, alternatively, the maximum drift.

L = height of story, in. (mm)

The additional lateral load at any level, N_i , shall be distributed over that level in the same manner as the gravity load at the level. The additional lateral loads shall be applied in the direction that provides the greatest destabilizing effect.

User Note: For most building structures, the requirement regarding the direction of N_i may be satisfied as follows: For load combinations that do not include lateral loading, consider two alternative orthogonal directions for the additional lateral load, in a positive and a negative sense in each of the two directions, same direction at all levels; for load combinations that include lateral loading, apply all the additional lateral loads in the direction of the resultant of all lateral loads in the combination.

- (2) The nonsway amplification of *beam-column* moments shall be considered by applying the B_1 amplifier of Appendix 8 to the total member moments.

User Note: Since there is no second-order analysis involved in the first-order analysis method for design by ASD, it is not necessary to amplify ASD load combinations by 1.6 before performing the analysis, as required in the *direct analysis method* and the *effective length method*.

3. Available Strengths

The *available strengths* of members and connections shall be calculated in accordance with the provisions of Chapters D, E, F, G, H, I, J and K, as applicable.

The *effective length factor*, K , of all members shall be taken as unity.

Bracing intended to define the *unbraced lengths* of members shall have sufficient *stiffness* and strength to control member movement at the braced points.

User Note: Methods of satisfying this requirement are provided in Appendix 6. The requirements of Appendix 6 are not applicable to bracing that is included in the analysis of the overall structure as part of the overall force-resisting system.

APPENDIX 8

APPROXIMATE SECOND-ORDER ANALYSIS

This appendix provides, as an alternative to a rigorous second-order analysis, a procedure to account for second-order effects in structures by amplifying the *required strengths* indicated by a *first-order analysis*.

The appendix is organized as follows:

- 8.1. Limitations
- 8.2. Calculation Procedure

8.1. LIMITATIONS

The use of this procedure is limited to structures that support *gravity loads* primarily through nominally vertical *columns*, walls or frames, except that it is permissible to use the procedure specified for determining *P-δ effects* for any individual compression member.

8.2. CALCULATION PROCEDURE

The *required second-order flexural strength*, M_r , and axial strength, P_r , of all members shall be determined as follows:

$$M_r = B_1 M_{nt} + B_2 M_{lt} \quad (\text{A-8-1})$$

$$P_r = P_{nt} + B_2 P_{lt} \quad (\text{A-8-2})$$

where

B_1 = multiplier to account for *P-δ effects*, determined for each member subject to compression and flexure, and each direction of bending of the member in accordance with Section 8.2.1. B_1 shall be taken as 1.0 for members not subject to compression.

B_2 = multiplier to account for *P-Δ effects*, determined for each story of the structure and each direction of lateral translation of the story in accordance with Section 8.2.2

M_{lt} = first-order moment using LRFD or ASD load combinations, due to lateral translation of the structure only, kip-in. (N-mm)

M_{nt} = first-order moment using LRFD or ASD load combinations, with the structure restrained against lateral translation, kip-in. (N-mm)

M_r = required second-order flexural strength using LRFD or ASD load combinations, kip-in. (N-mm)

P_{lt} = first-order axial force using LRFD or ASD load combinations, due to lateral translation of the structure only, kips (N)

P_{nt} = first-order axial force using LRFD or ASD load combinations, with the structure restrained against lateral translation, kips (N)

P_r = required second-order axial strength using LRFD or ASD load combinations, kips (N)

User Note: Equations A-8-1 and A-8-2 are applicable to all members in all structures. Note, however, that B_1 values other than unity apply only to moments in *beam-columns*; B_2 applies to moments and axial forces in components of the *lateral force resisting system* (including *columns*, beams, *bracing* members and *shear walls*). See Commentary for more on the application of Equations A-8-1 and A-8-2.

1. Multiplier B_1 for P - δ Effects

The B_1 multiplier for each member subject to compression and each direction of bending of the member is calculated as follows:

$$B_1 = \frac{C_m}{1 - \alpha P_r / P_{e1}} \geq 1 \quad (\text{A-8-3})$$

where

α = 1.00 (LRFD); α = 1.60 (ASD)

C_m = coefficient assuming no lateral translation of the frame determined as follows:

- (a) For *beam-columns* not subject to transverse loading between supports in the plane of bending

$$C_m = 0.6 - 0.4(M_1/M_2) \quad (\text{A-8-4})$$

where M_1 and M_2 , calculated from a *first-order analysis*, are the smaller and larger moments, respectively, at the ends of that portion of the member unbraced in the plane of bending under consideration. M_1/M_2 is positive when the member is bent in *reverse curvature*, negative when bent in *single curvature*.

- (b) For beam-columns subject to transverse loading between supports, the value of C_m shall be determined either by analysis or conservatively taken as 1.0 for all cases.

P_{e1} = elastic critical *buckling strength* of the member in the plane of bending, calculated based on the assumption of no lateral translation at the member ends, kips (N)

$$P_{e1} = \frac{\pi^2 EI^*}{(K_1 L)^2} \quad (\text{A-8-5})$$

where

EI^* = flexural rigidity required to be used in the analysis (= $0.8\tau_b EI$ when used in the *direct analysis method* where τ_b is as defined in Chapter C; = EI for the effective length and first-order analysis methods)

E = modulus of elasticity of steel = 29,000 ksi (200 000 MPa)

I = moment of inertia in the plane of bending, in.⁴ (mm⁴)

L = length of member, in. (mm)

K_1 = *effective length factor* in the plane of bending, calculated based on the assumption of no lateral translation at the member ends, set equal to 1.0 unless analysis justifies a smaller value

It is permitted to use the first-order estimate of P_r (i.e., $P_r = P_{nt} + P_{lt}$) in Equation A-8-3.

2. Multiplier B_2 for P - Δ Effects

The B_2 multiplier for each story and each direction of lateral translation is calculated as follows:

$$B_2 = \frac{1}{1 - \frac{\alpha P_{story}}{P_{e story}}} \geq 1 \quad (\text{A-8-6})$$

where

α = 1.00 (LRFD); α = 1.60 (ASD)

P_{story} = total vertical *load* supported by the story using *LRFD* or *ASD load combinations*, as applicable, including loads in *columns* that are not part of the *lateral force resisting system*, kips (N)

$P_{e story}$ = elastic critical *buckling strength* for the story in the direction of translation being considered, kips (N), determined by *sidesway buckling* analysis or as:

$$P_{e story} = R_M \frac{HL}{\Delta_H} \quad (\text{A-8-7})$$

where

$$R_M = 1 - 0.15 (P_{mf}/P_{story}) \quad (\text{A-8-8})$$

L = height of story, in. (mm)

P_{mf} = total vertical load in columns in the story that are part of *moment frames*, if any, in the direction of translation being considered (= 0 for *braced frame* systems), kips (N)

Δ_H = first-order interstory *drift*, in the direction of translation being considered, due to lateral forces, in. (mm), computed using the *stiffness* required to be used in the analysis (stiffness reduced as provided in Section C2.3 when the *direct analysis method* is used). Where Δ_H varies over the plan area of the structure, it shall be the average drift weighted in proportion to vertical load or, alternatively, the maximum drift.

H = story shear, in the direction of translation being considered, produced by the lateral forces used to compute Δ_H , kips (N)

User Note: H and Δ_H in Equation A-8-7 may be based on any lateral loading that provides a representative value of story lateral stiffness, H/Δ_H .

COMMENTARY

on the Specification for Structural Steel Buildings

June 22, 2010

(The Commentary is not a part of ANSI/AISC 360-10, *Specification for Structural Steel Buildings*, but is included for informational purposes only.)

INTRODUCTION

The Specification is intended to be complete for normal design usage.

The Commentary furnishes background information and references for the benefit of the design professional seeking further understanding of the basis, derivations and limits of the Specification.

The Specification and Commentary are intended for use by design professionals with demonstrated engineering competence.

COMMENTARY SYMBOLS

The Commentary uses the following symbols in addition to the symbols defined in the Specification. The section number in the right-hand column refers to the Commentary section where the symbol is first used.

Symbol	Definition	Section
A	Angle cross-sectional area, in. ² (mm ²)	G4
B	Overall width of rectangular HSS, in. (mm)	I3
C_f	Compression force in concrete slab for fully composite beam; smaller of $F_y A_s$ and $0.85f'_c A_c$, kips (N)	I3.2
F_y	Reported yield stress, ksi (MPa)	App. 5.2.2
F_{ys}	Static yield stress, ksi (MPa)	App. 5.2.2
H	Overall height of rectangular HSS, in. (mm)	I3
H	Anchor height, in. (mm)	I8.2b
I_g	Moment of inertia of gross concrete section about centroidal axis, neglecting reinforcement, in. ⁴ (mm ⁴)	I2.1b
I_{LB}	Lower bound moment of inertia, in. ⁴ (mm ⁴)	I3.2
I_{pos}	Effective moment of inertia for positive moment, in. ⁴ (mm ⁴)	I3.2
I_{neg}	Effective moment of inertia for negative moment, in. ⁴ (mm ⁴)	I3.2
I_s	Moment of inertia for the structural steel section, in. ⁴ (mm ⁴)	I3.2
I_{tr}	Moment of inertia for the fully composite uncracked transformed section, in. ⁴ (mm ⁴)	I3.2
$I_{y\ Top}$	Moment of inertia of the top flange about an axis through the web, in. ⁴ (mm ⁴)	F1
I_y	Moment of inertia of the entire section about an axis through the web, in. ⁴ (mm ⁴)	F1
K_S	Secant stiffness, ksi (MPa)	B3.6
M_{CL}	Moment at the middle of the unbraced length, kip-in. (N-mm)	F1
M_S	Moment at service loads, kip-in. (N-mm)	B3.6
M_T	Torsional moment, kip-in. (N-mm)	G4
M_o	Maximum first-order moment within the member due to the transverse loading, kip-in. (N-mm)	App. 8
N	Number of cycles to failure	App. 3.3
Q_m	Mean value of the load effect Q	B3.3
R_{cap}	Minimum rotation capacity	App. 1.2.2
R_m	Mean value of the resistance R	B3.3
S_r	Stress range	App. 3.3
S_s	Section modulus for the structural steel section, referred to the tension flange, in. ³ (mm ³)	I3.2
S_{tr}	Section modulus for the fully composite uncracked transformed section, referred to the tension flange of the steel section, in. ³ (mm ³)	I3.2
V_Q	Coefficient of variation of the load effect Q	B3.3

V_R	Coefficient of variation of the resistance R	B3.3
V_b	Component of the shear force parallel to the angle leg with width b and thickness t , kips (N)	G4
a_{cr}	Distance from the compression face to the neutral axis for a slender section, in. (mm)	I3
a_p	Distance from the compression face to the neutral axis for a compact section, in. (mm)	I3
a_y	Distance from the compression face to the neutral axis for a noncompact section, in. (mm)	I3
f_v	Shear stress in angle, ksi (MPa)	G4
k	Plate buckling coefficient characteristic of the type of plate edge-restraint	E7.1
β	Reliability index	B3.3
β_{act}	Actual bracing stiffness provided	App. 6.1
δ_o	Maximum deflection due to transverse loading, in. (mm)	App. 8
ν	Poisson's ratio	E7.1
θ_s	Rotation at service loads, rad	B3.6

COMMENTARY GLOSSARY

The Commentary uses the following terms in addition to the terms defined in the Glossary of the Specification. The terms listed below are *italicized* where they first appear in a chapter in the Commentary text.

Alignment chart. Nomograph for determining the effective length factor, K , for some types of columns.

Biaxial bending. Simultaneous bending of a member about two perpendicular axes.

Brittle fracture. Abrupt cleavage with little or no prior ductile deformation.

Column curve. Curve expressing the relationship between axial column strength and slenderness ratio.

Critical load. Load at which a perfectly straight member under compression may either assume a deflected position or may remain undeflected, or a beam under flexure may either deflect and twist out of plane or remain in its in-plane deflected position, as determined by a theoretical stability analysis.

Cyclic load. Repeatedly applied external load that may subject the structure to fatigue.

Drift damage index. Parameter used to measure the potential damage caused by *interstory drift*.

Effective moment of inertia. Moment of inertia of the cross section of a member that remains elastic when partial plastification of the cross section takes place, usually under the combination of *residual stress* and applied stress; also, the moment of inertia based on effective widths of elements that buckle locally; also, the moment of inertia used in the design of partially composite members.

Effective stiffness. Stiffness of a member computed using the *effective moment of inertia* of its cross section.

Fatigue threshold. Stress range at which fatigue cracking will not initiate regardless of the number of cycles of loading.

First-order plastic analysis. *Structural analysis* based on the assumption of rigid-plastic behavior—in other words, that equilibrium is satisfied throughout the structure and the stress is at or below the yield stress—and in which equilibrium conditions are formulated on the undeformed structure.

Flexible connection. Connection permitting a portion, but not all, of the simple beam rotation of a member end.

Inelastic action. Material deformation that does not disappear on removal of the force that produced it.

Interstory drift. Lateral deflection of a floor relative to the lateral deflection of the floor immediately below, divided by the distance between floors, $(\delta_n - \delta_{n-1})/h$.

Permanent load. Load in which variations over time are rare or of small magnitude. All other loads are *variable loads*.

- Plastic plateau.* Portion of the stress-strain curve for uniaxial tension or compression in which the stress remains essentially constant during a period of substantially increased strain.
- Primary member.* For ponding analysis, beam or girder that supports the concentrated reactions from the *secondary members* framing into it.
- Residual stress.* Stress that remains in an unloaded member after it has been formed into a finished product. (Examples of such stresses include, but are not limited to, those induced by cold bending, cooling after rolling, or welding).
- Rigid frame.* Structure in which connections maintain the angular relationship between beam and column members under load.
- Secondary member.* For ponding analysis, beam or joist that directly supports the distributed ponding loads on the roof of the structure.
- Sidesway.* Lateral movement of a structure under the action of lateral loads, unsymmetrical vertical loads or unsymmetrical properties of the structure.
- Sidesway buckling.* Buckling mode of a multistory frame precipitated by the relative lateral displacements of joints, leading to failure by *sidesway* of the frame.
- St. Venant torsion.* Portion of the torsion in a member that induces only shear stresses in the member.
- Strain hardening.* Phenomenon wherein ductile steel, after undergoing considerable deformation at or just above yield point, exhibits the capacity to resist substantially higher loading than that which caused initial yielding.
- Stub-column.* A short compression test specimen utilizing the complete cross section, sufficiently long to provide a valid measure of the stress-strain relationship as averaged over the cross section, but short enough so that it will not buckle as a column in the elastic or plastic range.
- Total building drift.* Lateral frame deflection at the top of the most occupied floor divided by the height of the building to that level, Δ/H .
- Undercut.* Notch resulting from the melting and removal of base metal at the edge of a weld.
- Variable load.* Load with substantial variation over time.
- Warping torsion.* Portion of the total resistance to torsion that is provided by resistance to warping of the cross section.

CHAPTER A

GENERAL PROVISIONS

A1. SCOPE

The scope of this Specification is essentially the same as the 2005 *Specification for Structural Steel Buildings* that it replaces, with the exception of a new Chapter N, Quality Control and Quality Assurance.

The basic purpose of the provisions in this Specification is the determination of the nominal and available strengths of the members, connections and other components of steel building structures.

This Specification provides two methods of design:

- (1) **Load and Resistance Factor Design (LRFD):** The nominal strength is multiplied by a resistance factor, ϕ , and the resulting design strength is then required to equal or exceed the required strength determined by structural analysis for the appropriate LRFD load combinations specified by the applicable building code.
- (2) **Allowable Strength Design (ASD):** The nominal strength is divided by a safety factor, Ω , and the resulting allowable strength is then required to equal or exceed the required strength determined by structural analysis for the appropriate ASD load combinations specified by the applicable building code.

This Specification gives provisions for determining the values of the nominal strengths according to the applicable limit states and lists the corresponding values of the resistance factor, ϕ , and the safety factor, Ω . Nominal strength is usually defined in terms of resistance to a load effect, such as axial force, bending moment, shear or torque, but in some instances it is expressed in terms of a stress. The ASD safety factors are calibrated to give the same structural reliability and the same component size as the LRFD method at a live-to-dead load ratio of 3. The term available strength is used throughout the Specification to denote design strength and allowable strength, as applicable.

This Specification is applicable to both buildings and other structures. Many structures found in petrochemical plants, power plants, and other industrial applications are designed, fabricated and erected in a manner similar to buildings. It is not intended that this Specification address steel structures with vertical and lateral load-resisting systems that are not similar to buildings, such as those constructed of shells or catenary cables.

The Specification may be used for the design of structural steel elements, as defined in the AISC *Code of Standard Practice for Steel Buildings and Bridges* (AISC, 2010a), hereafter referred to as the *Code of Standard Practice*, when used as components of nonbuilding structures or other structures. Engineering judgment must be applied to the Specification requirements when the structural steel elements

are exposed to environmental or service conditions and/or loads not usually applicable to building structures.

The *Code of Standard Practice* defines the practices that are the commonly accepted standards of custom and usage for structural steel fabrication and erection. As such, the *Code of Standard Practice* is primarily intended to serve as a contractual document to be incorporated into the contract between the buyer and seller of fabricated structural steel. Some parts of the *Code of Standard Practice*, however, form the basis for some of the provisions in this Specification. Therefore, the *Code of Standard Practice* is referenced in selected locations in this Specification to maintain the ties between these documents, where appropriate.

The Specification disallows seismic design of buildings and other structures using the provisions of Appendix 1. The *R*-factor specified in ASCE/SEI 7-10 (ASCE, 2010) used to determine the seismic loads is based on a nominal value of system overstrength and ductility that is inherent in steel structures designed by elastic analysis using this Specification. Therefore, it would be inappropriate to take advantage of the additional strength afforded by the inelastic design approach presented in Appendix 1 while simultaneously using the code specified *R*-factor. In addition, the provisions for ductility in Appendix 1 are not fully consistent with the intended levels for seismic design.

A2. REFERENCED SPECIFICATIONS, CODES AND STANDARDS

Section A2 provides references to documents cited in this Specification. Note that not all grades of a particular material specification are necessarily approved for use according to this Specification. For a list of approved materials and grades, see Section A3.

A3. MATERIAL

1. Structural Steel Materials

1a. ASTM Designations

There are hundreds of steel materials and products. This Specification lists those products/materials that are commonly useful to structural engineers and those that have a history of satisfactory performance. Other materials may be suitable for specific applications, but the evaluation of those materials is the responsibility of the engineer specifying them. In addition to typical strength properties, considerations for materials may include but are not limited to strength properties in transverse directions, ductility, formability, soundness, weldability including sensitivity to thermal cycles, notch toughness, and other forms of crack sensitivity, coatings, and corrosivity. Consideration for product form may include material considerations in addition to effects of production, tolerances, testing, reporting and surface profiles.

Hot-Rolled Structural Shapes. The grades of steel approved for use under this Specification, covered by ASTM specifications, extend to a yield stress of 100 ksi (690 MPa). Some of the ASTM specifications specify a minimum yield point, while

others specify a minimum yield strength. The term “yield stress” is used in this Specification as a generic term to denote either the yield point or the yield strength.

It is important to be aware of limitations of availability that may exist for some combinations of strength and size. Not all structural section sizes are included in the various material specifications. For example, the 60 ksi (415 MPa) yield stress steel in the A572/A572M specification includes plate only up to 1¹/₄ in. (32 mm) in thickness. Another limitation on availability is that even when a product is included in this Specification, it may be infrequently produced by the mills. Specifying these products may result in procurement delays or require ordering large quantities directly from the producing mills. Consequently, it is prudent to check availability before completing the details of a design. The AISC web site provides this information (www.aisc.org).

Properties in the direction of rolling are of principal interest in the design of steel structures. Hence, yield stress as determined by the standard tensile test is the principal mechanical property recognized in the selection of the steels approved for use under this Specification. It must be recognized that other mechanical and physical properties of rolled steel, such as anisotropy, ductility, notch toughness, formability, corrosion resistance, etc., may also be important to the satisfactory performance of a structure.

It is not possible to incorporate in the Commentary adequate information to impart full understanding of all factors that might merit consideration in the selection and specification of materials for unique or especially demanding applications. In such a situation the user of the Specification is advised to make use of reference material contained in the literature on the specific properties of concern and to specify supplementary material production or quality requirements as provided for in ASTM material specifications. One such case is the design of highly restrained welded connections (AISC, 1973). Rolled steel is anisotropic, especially insofar as ductility is concerned; therefore, weld contraction strains in the region of highly restrained welded connections may exceed the strength of the material if special attention is not given to material selection, details, workmanship and inspection.

Another special situation is that of fracture control design for certain types of service conditions (AASHTO, 2010). For especially demanding service conditions such as structures exposed to low temperatures, particularly those with impact loading, the specification of steels with superior notch toughness may be warranted. However, for most buildings, the steel is relatively warm, strain rates are essentially static, and the stress intensity and number of cycles of full design stress are low. Accordingly, the probability of fracture in most building structures is low. Good workmanship and good design details incorporating joint geometry that avoids severe stress concentrations are generally the most effective means of providing fracture-resistant construction.

Hollow Structural Sections (HSS). Specified minimum tensile properties are summarized in Table C-A3.1 for various HSS and pipe material specifications and grades. ASTM A53 Grade B is included as an approved pipe material specification because it is the most readily available round product in the United States. Other

TABLE C-A3.1
Minimum Tensile Properties of HSS
and Pipe Steels

Specification	Grade	F_y , ksi (MPa)	F_u , ksi (MPa)
ASTM A53	B	35 (240)	60 (415)
ASTM A500 (round)	B	42 (290)	58 (400)
	C	46 (315)	62 (425)
ASTM A500 (rectangular)	B	46 (315)	58 (400)
	C	50 (345)	62 (425)
ASTM A501	A	36 (250)	58 (400)
	B	50 (345)	70 (485)
ASTM A618 (round)	I and II	50 (345)	70 (485)
	($t \leq 3/4$ in.)		
	III	50 (345)	65 (450)
ASTM A847	—	50 (345)	70 (485)
CAN/CSA-G40.20/G40.21	350W	51 (350)	65 (450)

North American HSS products that have properties and characteristics that are similar to the approved ASTM products are produced in Canada under the *General Requirements for Rolled or Welded Structural Quality Steel* (CSA, 2004). In addition, pipe is produced to other specifications that meet the strength, ductility and weldability requirements of the materials in Section A3, but may have additional requirements for notch toughness or pressure testing.

Pipe can be readily obtained in ASTM A53 material and round HSS in ASTM A500 Grade B is also common. For rectangular HSS, ASTM A500 Grade B is the most commonly available material and a special order would be required for any other material. Depending upon size, either welded or seamless round HSS can be obtained. In North America, however, all ASTM A500 rectangular HSS for structural purposes are welded. Rectangular HSS differ from box sections in that they have uniform thickness except for some thickening in the rounded corners.

Nominal strengths of direct welded (T, Y & K) connections of HSS have been developed analytically and empirically. Connection deformation is anticipated and is an acceptance limit for connection tests. Ductility is necessary to achieve the expected deformations. The ratio of the specified yield strength to the specified tensile strength (yield/tensile ratio) is one measure of material ductility. Materials in HSS used in connection tests have had a yield/tensile ratio of up to 0.80 and therefore that ratio has been adopted as a limit of applicability for direct welded HSS connections. ASTM A500 Grade A material does not meet this ductility “limit of applicability” for direct connections in Chapter K. ASTM A500 Grade C has a yield/tensile ratio of 0.807 but it is reasonable to use the rounding method described in ASTM E29 and find this material acceptable for use.

Even though ASTM A501 includes rectangular HSS, hot-formed rectangular HSS are not currently produced in the United States. The *General Requirements for Rolled or Welded Structural Quality Steel* (CSA, 2004) includes Class C (cold-formed) and Class H (cold-formed and stress relieved) HSS. Class H HSS have relatively low levels of *residual stress*, which enhances their performance in compression and may provide better ductility in the corners of rectangular HSS.

1c. Rolled Heavy Shapes

The web-to-flange intersection and the web center of heavy hot-rolled shapes, as well as the interior portions of heavy plates, may contain a more coarse grain structure and/or lower notch toughness material than other areas of these products. This is probably caused by ingot segregation, the somewhat lesser deformation during hot rolling, higher finishing temperature, and the slower cooling rate after rolling for these heavy sections. This characteristic is not detrimental to suitability for compression members or for nonwelded members. However, when heavy cross sections are joined by splices or connections using complete-joint-penetration groove welds that extend through the coarser and/or lower notch-tough interior portions, tensile strains induced by weld shrinkage may result in cracking. An example is a complete-joint-penetration groove welded connection of a heavy cross section beam to any column section. When members of lesser thickness are joined by complete-joint-penetration groove welds, which induce smaller weld shrinkage strains, to the finer grained and/or more notch-tough surface material of ASTM A6/A6M shapes and heavy built-up cross sections, the potential for cracking is significantly lower. An example is a complete-joint-penetration groove welded connection of a nonheavy cross section beam to a heavy cross section column.

For critical applications such as primary tension members, material should be specified to provide adequate notch toughness at service temperatures. Because of differences in the strain rate between the Charpy V-notch (CVN) impact test and the strain rate experienced in actual structures, the CVN test is conducted at a temperature higher than the anticipated service temperature for the structure. The location of the CVN test specimens (“alternate core location”) is specified in ASTM A6/A6M, Supplemental Requirement S30.

The notch toughness requirements of Section A3.1c are intended only to provide material of reasonable notch toughness for ordinary service applications. For unusual applications and/or low temperature service, more restrictive requirements and/or notch toughness requirements for other section sizes and thicknesses may be appropriate. To minimize the potential for fracture, the notch toughness requirements of Section A3.1c must be used in conjunction with good design and fabrication procedures. Specific requirements are given in Sections J1.5, J1.6, J2.6 and J2.7.

For rotary-straightened W-shapes, an area of reduced notch toughness has been documented in a limited region of the web immediately adjacent to the flange. This region may exist in W-shapes of all weights, not just heavy shapes. Considerations in design and detailing that recognize this situation are presented in Chapter J.

2. Steel Castings and Forgings

There are a number of ASTM specifications for steel castings. The SFSA *Steel Castings Handbook* (SFSA, 1995) recommends ASTM A216 as a product useful for steel structures. In addition to the requirements of this Specification, SFSA recommends that various other requirements be considered for cast steel products. It may be appropriate to inspect the first piece cast using magnetic particle inspection in accordance with ASTM E125, degree 1a, b or c. Radiographic inspection level III may be desirable for critical sections of the first piece cast. Ultrasonic testing (UT) in compliance with ASTM A609/A609M (ASTM, 2007b) may be appropriate for the first cast piece over 6 in. thick. Design approval, sample approval, periodic non-destructive testing of the mechanical properties, chemical testing, and selection of the correct welding specification should be among the issues defined in the selection and procurement of cast steel products. Refer to SFSA (1995) for design information about cast steel products.

3. Bolts, Washers and Nuts

The ASTM standard specification for A307 bolts covers two grades of fasteners (ASTM, 2007c). Either grade may be used under this Specification; however, it should be noted that Grade B is intended for pipe flange bolting and Grade A is the grade long in use for structural applications.

4. Anchor Rods and Threaded Rods

ASTM F1554 is the primary specification for anchor rods. Since there is a limit on the maximum available length of ASTM A325/A325M and ASTM A490/A490M bolts, the attempt to use these bolts for anchor rods with design lengths longer than the maximum available lengths has presented problems in the past. The inclusion of ASTM A449 and A354 materials in this Specification allows the use of higher strength material for bolts longer than ASTM A325/A325M and ASTM A490/A490M bolts.

The engineer of record should specify the required strength for threaded rods used as load-carrying members.

5. Consumables for Welding

The AWS filler metal specifications listed in Section A3.5 are general specifications that include filler metal classifications suitable for building construction, as well as classifications that may not be suitable for building construction. The AWS D1.1/D1.1M, *Structural Welding Code—Steel* (AWS, 2010) lists in Table 3.1 various electrodes that may be used for prequalified welding procedure specifications, for the various steels that are to be joined. This list specifically does not include various classifications of filler metals that are not suitable for structural steel applications. Filler metals listed under the various AWS A5 specifications may or may not have specified notch toughness properties, depending on the specific electrode classification. Section J2.6 identifies certain welded joints where notch toughness of filler metal is needed in building construction. There may be other situations where the

engineer of record may elect to specify the use of filler metals with specified notch toughness properties, such as for structures subject to high loading rate, *cyclic loading*, or seismic loading. Since AWS D1.1/D1.1M does not automatically require that the filler metal used have specified notch toughness properties, it is important that filler metals used for such applications be of an AWS classification where such properties are required. This information can be found in the AWS Filler Metal Specifications and is often contained on the filler metal manufacturer's certificate of conformance or product specification sheets.

When specifying filler metal and/or flux by AWS designation, the applicable standard specifications should be carefully reviewed to assure a complete understanding of the designation reference. This is necessary because the AWS designation systems are not consistent. For example, in the case of electrodes for shielded metal arc welding (AWS A5.1), the first two or three digits indicate the nominal tensile strength classification, in ksi, of the filler metal and the final two digits indicate the type of coating. For metric designations, the first two digits times 10 indicate the nominal tensile strength classification in MPa. In the case of mild steel electrodes for submerged arc welding (AWS A5.17/A5.17M), the first one or two digits times 10 indicate the nominal tensile strength classification for both U.S. customary and metric units, while the final digit or digits times 10 indicate the testing temperature in °F, for filler metal impact tests. In the case of low-alloy steel covered arc welding electrodes (AWS A5.5), certain portions of the designation indicate a requirement for stress relief, while others indicate no stress relief requirement.

Engineers do not, in general, specify the exact filler metal to be employed on a particular structure. Rather, the decision as to which welding process and which filler metal is to be utilized is usually left with the fabricator or erector. Codes restrict the usage of certain filler materials, or impose qualification testing to prove the suitability of the specific electrode, so as to make certain that the proper filler metals are used.

A4. STRUCTURAL DESIGN DRAWINGS AND SPECIFICATIONS

The abbreviated list of requirements in this Specification is intended to be compatible with and a summary of the more extensive requirements in Section 3 of the *Code of Standard Practice*. The user should refer to Section 3 of the *Code of Standard Practice* for further information.

CHAPTER B

DESIGN REQUIREMENTS

B1. GENERAL PROVISIONS

Previous to the 2005 edition, the Specification contained a section entitled “Types of Construction”; for example, Section A2 in the 1999 *Load and Resistance Factor Design Specification for Structural Steel Buildings* (AISC, 2000b), hereafter referred to as the 1999 *LRFD Specification*. In this Specification there is no such section and the requirements related to “types of construction” have been divided between Section B1, Section B3.6 and Section J1.

Historically, “Types of Construction” was the section that established what type of structures the Specification covers. The preface to the 1999 *LRFD Specification* suggested that the purpose of the Specification was “to provide design criteria for routine use and not to provide specific criteria for infrequently encountered problems.” The preface to the 1978 *Specification for the Design, Fabrication, and Erection of Structural Steel for Buildings* (AISC, 1978) contained similar language. While “routine use” may be difficult to describe, the contents of “Types of Construction” have been clearly directed at ordinary building frames with beams, columns and connections.

The 1969 *Specification for the Design, Fabrication, and Erection of Structural Steel for Buildings* (AISC, 1969) classified “types of construction” as Type 1, 2 or 3. The primary distinction among these three types of construction was the nature of the connections of the beams to the columns. Type 1 construction referred to “*rigid frames*,” now called moment-resisting frames, which had connections capable of transmitting moment. Type 2 construction referred to “simple frames” with no moment transfer between beams and columns. Type 3 construction utilized “semi-rigid frames” with partially restrained connections. This system was allowed if a predictable and reliable amount of connection flexibility and moment transfer could be documented.

The 1986 *Load and Resistance Factor Design Specification for Structural Steel Buildings* (AISC, 1986) changed the designations from Type 1, 2 or 3 to the designations FR (fully restrained) and PR (partially restrained). In these designations, the term “restraint” refers to the degree of moment transfer and the associated deformation in the connections. The 1986 *LRFD Specification* also used the term “simple framing” to refer to structures with “simple connections,” that is, connections with negligible moment transfer. In essence, FR was equivalent to Type 1, “simple framing” was equivalent to Type 2, and PR was equivalent to Type 3 construction.

Type 2 construction of earlier Specifications and “simple framing” of the 1986 *LRFD Specification* had additional provisions that allowed the wind loads to be carried by moment resistance of selected joints of the frame, provided that:

- (1) The connections and connected members have capacity to resist the wind moments.
- (2) The girders are adequate to carry the full gravity load as “simple beams.”
- (3) The connections have adequate inelastic rotation capacity to avoid overstress of the fasteners or welds under combined gravity and wind loading.

The concept of “wind connections” as both simple (for gravity loads) and moment resisting (for wind loads) was proposed by Sourochnikoff (1950) and further examined by Disque (1964). The basic proposal asserted that such connections have some moment resistance but that this resistance is low enough under wind load such that the connections would sustain inelastic deformations. Under repeated (cyclic) wind loads, the connection response would appear to reach a condition where the gravity load moments would be very small. The proposal postulated that the elastic resistance of the connections to wind moments would remain the same as the initial resistance, although it is known that many connections do not exhibit a linear elastic initial response. Additional recommendations have been provided by Geschwindner and Disque (2005). More recent research has shown that the AISC direct analysis method, as defined in the 2005 *Specification for Structural Steel Buildings* (AISC, 2005a) and this Specification, is the best approach to cover all relevant response effects (White and Goverdhan, 2008).

Section B1 widens the purview of this Specification to a broader class of construction types. It recognizes that a structural system is a combination of members connected in such a way that the structure can respond in different ways to meet different design objectives under different loads. Even within the purview of ordinary buildings, there can be enormous variety in the design details.

This Specification is meant to be primarily applicable to the common types of building frames with gravity loads carried by beams and girders and lateral loads carried by moment frames, braced frames or shear walls. However, there are many unusual buildings or building-like structures for which this Specification is also applicable. Rather than attempt to establish the purview of the Specification with an exhaustive classification of construction types, Section B1 requires that the design of members and their connections be consistent with the intended use of the structure and the assumptions made in the analysis of the structure.

B2. LOADS AND LOAD COMBINATIONS

The loads and load combinations for use with this Specification are given in the applicable building code. In the absence of an applicable specific local, regional or national building code, the nominal loads (for example, D , L , L_r , S , R , W and E), load factors and load combinations are as specified in ASCE/SEI 7, *Minimum Design Loads for Buildings and Other Structures* (ASCE, 2010). This edition of ASCE/SEI 7 has adopted the seismic design provisions of the NEHRP *Recommended Seismic Provisions for New Buildings and Other Structures* (BSSC, 2009), as have the AISC *Seismic Provisions for Structural Steel Buildings* (AISC, 2010b). The reader is referred to the commentaries of these documents for an expanded discussion on loads, load factors and seismic design.

This Specification is based on strength limit states that apply to structural steel design in general. The Specification permits design for strength using either load and resistance factor design (LRFD) or allowable strength design (ASD). It should be noted that the terms strength and stress reflect whether the appropriate section property has been applied in the calculation of the limit state available strength. In most instances, the Specification uses strength rather than stress in the safety check. In all cases it is a simple matter to recast the provisions in a stress format. The terminology used to describe load combinations in ASCE/SEI 7 is somewhat different from that used by this Specification. Section 2.3 of ASCE/SEI 7 defines Combining Factored Loads Using Strength Design; these combinations are applicable to design using the LRFD approach. Section 2.4 of ASCE/SEI 7 defines Combining Nominal Loads Using Allowable Stress Design; these combinations are applicable to design using the ASD load approach. Both the LRFD and ASD load combinations in the current edition of ASCE/SEI 7 (ASCE, 2010) have been changed from those of previous editions as has the overall treatment of wind loads.

LRFD load combinations. If the LRFD approach is selected, the load combination requirements are defined in Section 2.3 of ASCE/SEI 7.

The load combinations in Section 2.3 of ASCE/SEI 7 are based on modern probabilistic load modeling and a comprehensive survey of reliabilities inherent in traditional design practice (Galambos et al., 1982; Ellingwood et al., 1982). These load combinations utilize a “principal action-companion action format,” which is based on the notion that the maximum combined load effect occurs when one of the time-varying loads takes on its maximum lifetime value (principal action) while the other *variable loads* are at “arbitrary point-in-time” values (companion actions), the latter being loads that would be measured in a load survey at any arbitrary time. The dead load, which is considered to be permanent, is the same for all combinations in which the load effects are additive. Research has shown that this approach to load combination analysis is consistent with the manner in which loads actually combine on structural elements and systems in situations in which strength limit states may be approached. The load factors reflect uncertainty in individual load magnitudes and in the analysis that transforms load to load effect. The nominal loads in ASCE/SEI 7 are substantially in excess of the arbitrary point-in-time values. The nominal live, wind and snow loads historically have been associated with mean return periods of approximately 50 years. Wind loads historically have been adjusted upward by a high load factor in previous editions to approximate a longer return period; in the 2010 edition of ASCE/SEI 7 the load factor is 1.0 and the wind-speed maps correspond to return periods deemed appropriate for the design of each occupancy type (approximately 700 years for common occupancies).

The return period associated with earthquake loads has been more complex historically and the approach has been revised in both the 2003 and 2009 editions of the *NEHRP Recommended Seismic Provisions for New Buildings and Other Structures* (BSSC, 2003, 2009). In the 2009 edition, adopted as the basis for ASCE/SEI 7-10, the earthquake loads calculated at most locations are intended to produce a uniform maximum collapse probability of 1% in a 50 year period by integrating the collapse probability (a product of hazard amplitude and an assumed structural fragility) across

all return periods. At some sites in regions of high seismic activity, where high intensity events occur frequently, deterministic limits on the ground motion result in somewhat higher collapse probabilities. Commentary to Chapter 1 of ASCE/SEI 7-10 provides information on the intended maximum probability of structural failure under earthquake and other loads.

Load combinations of ASCE/SEI 7, Section 2.3, which apply specifically to cases in which the structural actions due to lateral forces and gravity loads counteract one another and the dead load stabilizes the structure, incorporate a load factor on dead load of 0.9.

ASD Load Combinations. If the ASD approach is selected, the load combination requirements are defined in Section 2.4 of ASCE/SEI 7.

The load combinations in Section 2.4 of ASCE/SEI 7 are similar to those traditionally used in allowable stress design. In ASD, safety is provided by the safety factor, Ω , and the nominal loads in the basic combinations involving gravity loads, earth pressure or fluid pressure are not factored. The reduction in the combined time-varying load effect in combinations incorporating wind or earthquake load is achieved by the load combination factor 0.75. This load combination factor dates back to the 1972 edition of ANSI Standard A58.1, the predecessor of ASCE/SEI 7. It should be noted that in ASCE/SEI 7, the 0.75 factor applies only to combinations of variable loads; it is irrational to reduce the dead load because it is always present and does not fluctuate in time. It should also be noted that certain ASD load combinations may actually result in a higher required strength than similar load combinations for LRFD. Load combinations that apply specifically to cases in which the structural actions due to lateral forces and gravity loads counteract one another, where the dead load stabilizes the structure, incorporate a load factor on dead load of 0.6. This eliminates a deficiency in the traditional treatment of counteracting loads in allowable stress design and emphasizes the importance of checking stability. The earthquake load effect is multiplied by 0.7 in applicable combinations involving that load to align allowable strength design for earthquake effects with the definition of E in the sections of ASCE/SEI 7 defining Seismic Load Effects and Combinations.

The load combinations in Sections 2.3 and 2.4 of ASCE/SEI 7 apply to design for strength limit states. They do not account for gross error or negligence. Loads and load combinations for nonbuilding structures and other structures may be defined in ASCE/SEI 7 or other applicable industry standards and practices.

B3. DESIGN BASIS

Load and resistance factor design (LRFD) and allowable strength design (ASD) are distinct methods. They are equally acceptable by this Specification, but their provisions are not identical and not interchangeable. Indiscriminate use of combinations of the two methods could result in unpredictable performance or unsafe design. Thus, the LRFD and ASD methods are specified as alternatives. There are, however, circumstances in which the two methods could be used in the design, modification or renovation of a structural system without conflict, such as providing modifications to a structural floor system of an older building after assessing the as-built conditions.

1. Required Strength

This Specification permits the use of elastic, inelastic or plastic structural analysis. Generally, design is performed by elastic analysis. Provisions for inelastic and plastic analysis are given in Appendix 1. The required strength is determined by the appropriate methods of structural analysis.

In some circumstances, as in the proportioning of stability bracing members that carry no calculated forces (see, for example, Appendix 6), the required strength is explicitly stated in this Specification.

2. Limit States

A limit state is a condition in which a structural system or component becomes unfit for its intended purpose (serviceability limit state), or has reached its ultimate load-carrying capacity (strength limit state). Limit states may be dictated by functional requirements, such as maximum deflections or drift; they may be related to structural behavior, such as the formation of a plastic hinge or mechanism; or they may represent the collapse of the whole or part of the structure, such as by instability or fracture. The design provisions in the Specification ensure that the probability of exceeding a limit state is acceptably small by stipulating the combination of load factors, resistance or safety factors, nominal loads and nominal strengths consistent with the design assumptions.

Two kinds of limit states apply to structures: (1) strength limit states, which define safety against local or overall failure conditions during the intended life of the structure; and (2) serviceability limit states, which define functional requirements. This Specification, like other structural design codes, focuses primarily on strength limit states because of overriding considerations of public safety. This does not mean that limit states of serviceability (see Chapter L) are not important to the designer, who must provide for functional performance and economy of design. However, serviceability considerations permit more exercise of judgment on the part of the designer.

Strength limit states vary from element to element, and several limit states may apply to a given element. The most common strength limit states are yielding, buckling and rupture. The most common serviceability limit states include deflections or drift, and vibrations.

Structural integrity provisions that establish minimum requirements for connectivity have been introduced into various building codes. The intent of those provisions is to provide a minimum level of robustness for the structure to enhance its performance under an extraordinary event. The requirements are prescriptive in nature, as the forces generated by the undefined extraordinary event may exceed those due to the minimum nominal loads stipulated by the building code. Unless specifically prohibited by the applicable building code, the full ductile load-deformation (stress-strain) response of steel may be used to calculate the nominal capacity to satisfy nominal strength requirements prescribed for structural integrity.

The performance criteria for structural integrity are different from the traditional design methodology where serviceability and strength limit states, such as limiting

deformation and preventing yielding, often control connection design. Thus, Section B3.2 establishes that limit states checked during design for traditional loads and load combinations involving limiting deformations or yielding of connection components are not necessary for the structural integrity checks. Thus, as examples of the application of these provisions, this section removes the limitation on inelastic yielding of double angles in a beam connection as they tend to straighten when subjected to high axial tension forces or the substantial deformation of bolt holes that might be restricted in traditional connection design.

In addition, this section permits the use of short-slots parallel to the direction of the specified tension force without triggering the slip-critical requirements, contrary to traditional connection design, since movement of the bolt in the slot during an extraordinary event is not detrimental to overall structural performance. In this case, bolts are assumed to be located at the critical end of the slot for all applicable limit states.

Single-plate shear connection design to meet structural integrity requirements is discussed in Geschwindner and Gustafson (2010).

3. Design for Strength Using Load and Resistance Factor Design (LRFD)

Design for strength by LRFD is performed in accordance with Equation B3-1. The left side of Equation B3-1, R_u , represents the required strength computed by structural analysis based on load combinations stipulated in ASCE/SEI 7 (ASCE, 2010), Section 2.3 (or their equivalent), while the right side, ϕR_n , represents the limiting structural resistance, or design strength, provided by the member or element.

The resistance factor, ϕ , in this Specification is equal to or less than 1.0. When compared to the nominal strength, R_n , computed according to the methods given in Chapters D through K, a ϕ of less than 1.0 accounts for approximations in the theory and variations in mechanical properties and dimensions of members and frames. For limit states where $\phi = 1.00$, the nominal strength is judged to be sufficiently conservative when compared to the actual strength that no reduction is needed.

The LRFD provisions are based on: (1) probabilistic models of loads and resistance; (2) a calibration of the LRFD provisions to the 1978 edition of the ASD Specification for selected members; and (3) the evaluation of the resulting provisions by judgment and past experience aided by comparative design office studies of representative structures.

In the probabilistic basis for LRFD (Ravindra and Galambos, 1978; Ellingwood et al., 1982), the load effects, Q , and the resistances, R , are modeled as statistically independent random variables. In Figure C-B3.1, relative frequency distributions for Q and R are portrayed as separate curves on a common plot for a hypothetical case. As long as the resistance, R , is greater than (to the right of) the effects of the loads, Q , a margin of safety for the particular limit state exists. However, because Q and R are random variables, there is a small probability that R may be less than Q . The probability of this limit state is related to the degree of overlap of the frequency distributions in Figure C-B3.1, which depends on the positioning of their mean values (R_m versus Q_m) and their dispersions.

The probability that R is less than Q depends on the distributions of the many variables (material, loads, etc.) that determine resistance and total load effect. Often, only the means and the standard deviations or coefficients of variation of the variables involved in the determination of R and Q can be estimated. However, this information is sufficient to build an approximate design provision that is independent of the knowledge of these distributions, by stipulating the following design condition:

$$\beta \sqrt{V_R^2 + V_Q^2} \leq \ln(R_m/Q_m) \quad (\text{C-B3-1})$$

where

R_m = mean value of the resistance R

Q_m = mean value of the load effect Q

V_R = coefficient of variation of the resistance R

V_Q = coefficient of variation of the load effect Q

For structural elements and the usual loading, R_m , Q_m , and the coefficients of variation, V_R and V_Q , can be estimated, so a calculation of

$$\beta = \frac{\ln(R_m / Q_m)}{\sqrt{V_R^2 + V_Q^2}} \quad (\text{C-B3-2})$$

will give a comparative measure of reliability of a structure or component. The parameter β is denoted the reliability index. Extensions to the determination of β in Equation C-B3-2 to accommodate additional probabilistic information and more complex design situations are described in Ellingwood et al. (1982) and have been used in the development of the recommended load combinations in ASCE/SEI 7.

The original studies that determined the statistical properties (mean values and coefficients of variation) for the basic material properties and for steel beams, columns, composite beams, plate girders, beam-columns and connection elements that were

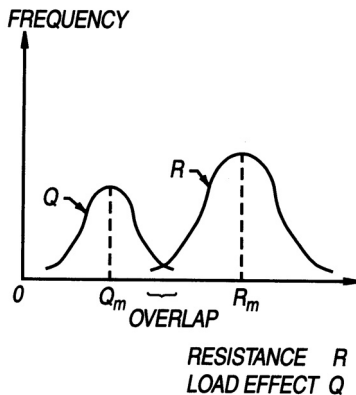

Fig. C-B3.1. Frequency distribution of load effect Q and resistance R .

used to develop the LRFD provisions are presented in a series of eight articles in the September 1978 issue of the *Journal of the Structural Division* (ASCE, Vol. 104, ST9). The corresponding load statistics are given in Galambos et al. (1982). Based on these statistics, the values of β inherent in the 1978 *Specification for the Design, Fabrication, and Erection of Structural Steel for Buildings* (AISC, 1978) were evaluated under different load combinations (live/dead, wind/dead, etc.) and for various tributary areas for typical members (beams, columns, beam-columns, structural components, etc.). As might be expected, there was a considerable variation in the range of β -values. For example, compact rolled beams (flexure) and tension members (yielding) had β -values that decreased from about 3.1 at $L/D = 0.50$ to 2.4 at $L/D = 4$. This decrease is a result of ASD applying the same factor to dead load, which is relatively predictable, and live load, which is more variable. For bolted or welded connections, β was in the range of 4 to 5.

The variation in β that was inherent to ASD is reduced substantially in LRFD by specifying several target β -values and selecting load and resistance factors to meet these targets. The Committee on Specifications set the point at which LRFD is calibrated to ASD at $L/D = 3.0$ for braced compact beams in flexure and tension members at yield. The resistance factor, ϕ , for these limit states is 0.90, and the implied β is approximately 2.6 for members and 4.0 for connections. The larger β -value for connections reflects the complexity in modeling their behavior, effects of workmanship, and the benefit provided by additional strength. Limit states for other members are handled similarly.

The databases on steel strength used in previous editions of the *LRFD Specification for Structural Steel Buildings* were based mainly on research conducted prior to 1970. An important recent study of the material properties of structural shapes (Bartlett et al., 2003) reflected changes in steel production methods and steel materials that have occurred over the past 15 years. This study indicated that the new steel material characteristics did not warrant changes in the ϕ -values.

4. Design for Strength Using Allowable Strength Design (ASD)

The ASD method is provided in this Specification as an alternative to LRFD for use by engineers who prefer to deal with ASD load combinations and allowable stresses in the traditional ASD format. The term “allowable strength” has been introduced to emphasize that the basic equations of structural mechanics that underlie the provisions are the same for LRFD and ASD.

Traditional ASD is based on the concept that the maximum stress in a component shall not exceed a specified allowable stress under normal service conditions. The load effects are determined on the basis of an elastic analysis of the structure, while the allowable stress is the limiting stress (at yielding, instability, rupture, etc.) divided by a safety factor. The magnitude of the safety factor and the resulting allowable stress depend on the particular governing limit state against which the design must produce a certain margin of safety. For any single element, there may be a number of different allowable stresses that must be checked.

The safety factor in traditional ASD provisions was a function of both the material and the component being considered. It may have been influenced by factors such as member length, member behavior, load source and anticipated quality of workmanship. The traditional safety factors were based solely on experience and have remained unchanged for over 50 years. Although ASD-designed structures have performed adequately over the years, the actual level of safety provided was never known. This was a principal drawback of the traditional ASD approach. An illustration of typical performance data is provided in Bjorhovde (1978), where theoretical and actual safety factors for columns are examined.

Design for strength by ASD is performed in accordance with Equation B3-2. The ASD method provided in the Specification recognizes that the controlling modes of failure are the same for structures designed by ASD and LRFD. Thus, the nominal strength that forms the foundation of LRFD is the same nominal strength that provides the foundation for ASD. When considering available strength, the only difference between the two methods is the resistance factor in LRFD, ϕ , and the safety factor in ASD, Ω .

In developing appropriate values of Ω for use in this Specification, the aim was to ensure similar levels of safety and reliability for the two methods. A straightforward approach for relating the resistance factor and the safety factor was developed. As already mentioned, the original LRFD Specification was calibrated to the 1978 *ASD Specification* at a live load to dead load ratio of 3. Thus, by equating the designs for the two methods at a ratio of live-to-dead load of 3, the relationship between ϕ and Ω can be determined. Using the live plus dead load combinations, with $L = 3D$, yields the following relationships.

For design according to Section B3.3 (LRFD):

$$\phi R_n = 1.2D + 1.6L = 1.2D + 1.6(3D) = 6D \quad (\text{C-B3-3})$$

$$R_n = \frac{6D}{\phi}$$

For design according to Section B3.4 (ASD):

$$\frac{R_n}{\Omega} = D + L = D + 3D = 4D \quad (\text{C-B3-4})$$

$$R_n = \Omega (4D)$$

Equating R_n from the LRFD and ASD formulations and solving for Ω yields

$$\Omega = \frac{6D}{\phi} \left(\frac{1}{4D} \right) = \frac{1.5}{\phi} \quad (\text{C-B3-5})$$

Throughout the Specification, the values of Ω were obtained from the values of ϕ by Equation C-B3-5.

5. Design for Stability

Section B3.5 provides the charging language for Chapter C on design for stability.

6. Design of Connections

Section B3.6 provides the charging language for Chapter J and Chapter K on the design of connections. Chapter J covers the proportioning of the individual elements of a connection (angles, welds, bolts, etc.) once the load effects on the connection are known. Section B3.6 establishes that the modeling assumptions associated with the structural analysis must be consistent with the conditions used in Chapter J to proportion the connecting elements.

In many situations, it is not necessary to include the connection elements as part of the analysis of the structural system. For example, simple and FR connections may often be idealized as pinned or fixed, respectively, for the purposes of structural analysis. Once the analysis has been completed, the deformations or forces computed at the joints may be used to proportion the connection elements. The classifications of FR (fully restrained) and simple connections are meant to justify these idealizations for analysis with the provision that if, for example, one assumes a connection to be FR for the purposes of analysis, the actual connection must meet the FR conditions. In other words, it must have adequate strength and stiffness, as described in the provisions and discussed below.

In certain cases, the deformation of the connection elements affects the way the structure resists load and hence the connections must be included in the analysis of the structural system. These connections are referred to as partially restrained (PR) moment connections. For structures with PR connections, the connection flexibility must be estimated and included in the structural analysis, as described in the following sections. Once the analysis is complete, the load effects and deformations computed for the connection can be used to check the adequacy of the connecting elements.

For simple and FR connections, the connection proportions are established after the final analysis of the structural design is completed, thereby greatly simplifying the design cycle. In contrast, the design of PR connections (like member selection) is inherently iterative because one must assume values of the connection proportions in order to establish the force-deformation characteristics of the connection needed to perform the structural analysis. The life-cycle performance characteristics must also be considered. The adequacy of the assumed proportions of the connection elements can be verified once the outcome of the structural analysis is known. If the connection elements are inadequate, then the values must be revised and the structural analysis repeated. The potential benefits of using PR connections for various types of framing systems are discussed in the literature.

Connection Classification. The basic assumption made in classifying connections is that the most important behavioral characteristics of the connection can be modeled by a moment-rotation ($M-\theta$) curve. Figure C-B3.2 shows a typical $M-\theta$ curve. Implicit in the moment-rotation curve is the definition of the connection as being a region of the column and beam along with the connecting elements. The connection

response is defined this way because the rotation of the member in a physical test is generally measured over a length that incorporates the contributions of not only the connecting elements, but also the ends of the members being connected and the column panel zone.

Examples of connection classification schemes include those in Bjorhovde et al. (1990) and Eurocode 3 (CEN, 2005). These classifications account directly for the stiffness, strength and ductility of the connections.

Connection Stiffness. Because the nonlinear behavior of the connection manifests itself even at low moment-rotation levels, the initial stiffness of the connection (shown in Figure C-B3.2) does not adequately characterize connection response at service levels. Furthermore, many connection types do not exhibit a reliable initial stiffness, or it exists only for a very small moment-rotation range. The secant stiffness, K_S , at service loads is taken as an index property of connection stiffness. Specifically,

$$K_S = M_S / \theta_S \quad (\text{C-B3-6})$$

where

M_S = moment at service loads, kip-in. (N-mm)

θ_S = rotation at service loads, rad

In the discussion below, L and EI are the length and bending rigidity, respectively, of the beam.

If $K_S L / EI \geq 20$, it is acceptable to consider the connection to be fully restrained (in other words, able to maintain the angles between members). If $K_S L / EI \leq 2$, it is acceptable to consider the connection to be simple (in other words, it rotates without developing moment). Connections with stiffnesses between these two limits are partially restrained and the stiffness, strength and ductility of the connection must be

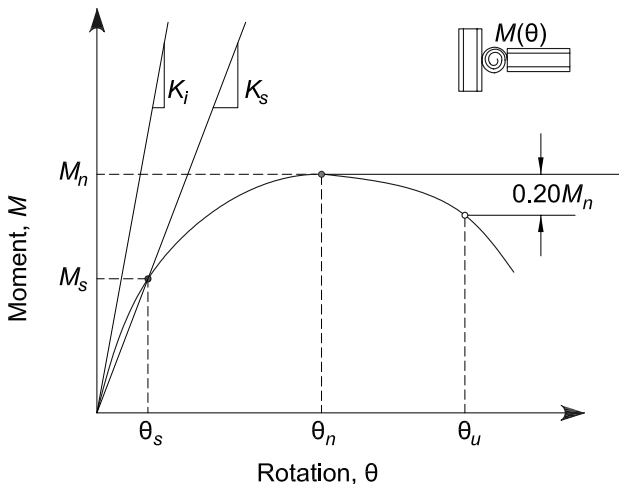

Fig. C-B3.2. Definition of stiffness, strength and ductility characteristics of the moment-rotation response of a partially restrained connection.

considered in the design (Leon, 1994). Examples of FR, PR and simple connection response curves are shown in Figure C-B3.3. The points marked θ_S indicate the service load states for the example connections and thereby define the secant stiffnesses for those connections.

Connection Strength. The strength of a connection is the maximum moment that it is capable of carrying, M_n , as shown in Figure C-B3.2. The strength of a connection can be determined on the basis of an ultimate limit-state model of the connection, or from a physical test. If the moment-rotation response does not exhibit a peak load then the strength can be taken as the moment at a rotation of 0.02 rad (Hsieh and Deierlein, 1991; Leon et al., 1996).

It is also useful to define a lower limit on strength below which the connection may be treated as a simple connection. Connections that transmit less than 20% of the fully plastic moment of the beam at a rotation of 0.02 rad may be considered to have no flexural strength for design. However, it should be recognized that the aggregate strength of many weak connections can be important when compared to that of a few strong connections (FEMA, 1997).

In Figure C-B3.3, the points marked M_n indicate the maximum strength states of the example connections. The points marked θ_u indicate the maximum rotation states of the example connections. Note that it is possible for an FR connection to have a strength less than the strength of the beam. It is also possible for a PR connection to have a strength greater than the strength of the beam.

The strength of the connection must be adequate to resist the moment demands implied by the design loads.

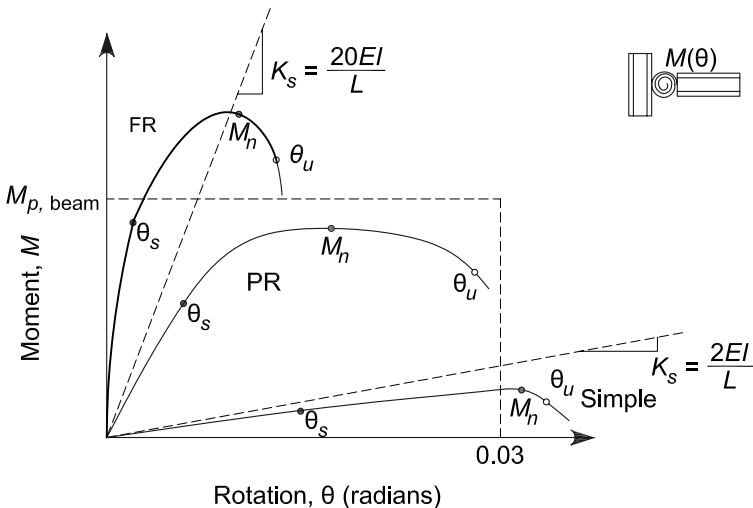

Fig. C-B3.3. Classification of moment-rotation response of fully restrained (FR), partially restrained (PR) and simple connections.

Connection Ductility. If the connection strength substantially exceeds the fully plastic moment of the beam, then the ductility of the structural system is controlled by the beam and the connection can be considered elastic. If the connection strength only marginally exceeds the fully plastic moment of the beam, then the connection may experience substantial inelastic deformation before the beam reaches its full strength. If the beam strength exceeds the connection strength, then deformations can concentrate in the connection. The ductility required of a connection will depend upon the particular application. For example, the ductility requirement for a braced frame in a nonseismic area will generally be less than the ductility required in a high seismic area. The rotation ductility requirements for seismic design depend upon the structural system (AISC, 2010b).

In Figure C-B3.2, the rotation capacity, θ_u , can be defined as the value of the connection rotation at the point where either (a) the resisting strength of the connection has dropped to $0.8M_n$ or (b) the connection has deformed beyond 0.03 rad. This second criterion is intended to apply to connections where there is no loss in strength until very large rotations occur. It is not prudent to rely on these large rotations in design.

The available rotation capacity, θ_u , should be compared with the rotation required at the strength limit state, as determined by an analysis that takes into account the nonlinear behavior of the connection. (Note that for design by ASD, the rotation required at the strength limit state should be assessed using analyses conducted at 1.6 times the ASD load combinations.) In the absence of an accurate analysis, a rotation capacity of 0.03 rad is considered adequate. This rotation is equal to the minimum beam-to-column connection capacity as specified in the seismic provisions for special moment frames (AISC, 2010b). Many types of PR connections, such as top and seat-angle connections, meet this criterion.

Structural Analysis and Design. When a connection is classified as PR, the relevant response characteristics of the connection must be included in the analysis of the structure to determine the member and connection forces, displacements and the frame stability. Therefore, PR construction requires, first, that the moment-rotation characteristics of the connection be known and, second, that these characteristics be incorporated in the analysis and member design.

Typical moment-rotation curves for many PR connections are available from one of several databases [for example, Goverdhan (1983); Ang and Morris (1984); Nethercot (1985); and Kishi and Chen (1986)]. Care should be exercised when utilizing tabulated moment-rotation curves not to extrapolate to sizes or conditions beyond those used to develop the database since other failure modes may control (ASCE Task Committee on Effective Length, 1997). When the connections to be modeled do not fall within the range of the databases, it may be possible to determine the response characteristics from tests, simple component modeling, or finite element studies (FEMA, 1995). Examples of procedures to model connection behavior are given in the literature (Bjorhovde et al., 1988; Chen and Lui, 1991; Bjorhovde et al., 1992; Lorenz et al., 1993; Chen and Toma, 1994; Chen et al., 1995; Bjorhovde et al., 1996; Leon et al., 1996; Leon and Easterling, 2002; Bijlaard et al., 2005; Bjorhovde et al., 2008).

The degree of sophistication of the analysis depends on the problem at hand. Design for PR construction usually requires separate analyses for the serviceability and strength limit states. For serviceability, an analysis using linear springs with a stiffness given by K_s (see Figure C-B3.2) is sufficient if the resistance demanded of the connection is well below the strength. When subjected to strength load combinations, a procedure is needed whereby the characteristics assumed in the analysis are consistent with those of the connection response. The response is especially nonlinear as the applied moment approaches the connection strength. In particular, the effect of the connection nonlinearity on second-order moments and other stability checks needs to be considered (ASCE Task Committee on Effective Length, 1997).

7. Moment Redistribution in Beams

A beam that is reliably restrained at one or both ends (either by connection to other members or by a support) will have reserve capacity past yielding at the point with the greatest moment predicted by an elastic analysis. The additional capacity is the result of inelastic redistribution of moments. This Specification bases the design of the member on providing a resisting moment greater than the demand represented by the greatest moment predicted by the elastic analysis. This approach ignores the reserve capacity associated with inelastic redistribution. The 10% reduction of the greatest moment predicted by elastic analysis (with the accompanying 10% increase in the moment on the reverse side of the moment diagram) is an attempt to account approximately for the reserve capacity.

This adjustment is appropriate only for cases where the inelastic redistribution of moments is possible. For statically determinate spans (e.g., beams that are simply supported at both ends or for cantilevers), redistribution is not possible. Therefore the adjustment is not allowable in these cases. Members with fixed ends or beams continuous over a support can sustain redistribution. Member sections that are unable to accommodate the inelastic rotation associated with the redistribution (e.g., because of local buckling) are also not permitted the reduction. Thus, only compact sections qualify for redistribution in this Specification.

An inelastic analysis will automatically account for any redistribution. Therefore, the redistribution of moments only applies to moments computed from an elastic analysis.

The 10% reduction rule applies only to beams. Inelastic redistribution is possible in more complicated structures, but the 10% amount is only verified, at present, for beams. For other structures, the provisions of Appendix 1 should be used.

8. Diaphragms and Collectors

This section provides charging language for the design of structural steel components (members and their connections) of diaphragms and collector systems.

Diaphragms transfer in-plane lateral loads to the lateral force resisting system. Typical diaphragm elements in a building structure are the floor and roof systems which accumulate lateral forces due to gravity, wind and/or seismic loads and distribute these forces to individual elements (braced frames, moment frames, shear

walls, etc.) of the vertically oriented lateral force resisting system of the building structure. Collectors (also known as drag struts) are often used to collect and deliver diaphragm forces to the lateral force resisting system.

Diaphragms are classified into one of three categories: rigid, semi-rigid or flexible. Rigid diaphragms distribute the in-plane forces to the lateral load resisting system with negligible in-plane deformation of the diaphragm. A rigid diaphragm may be assumed to distribute the lateral loads in proportion to the relative stiffness of the individual elements of the lateral force resisting system. A semi-rigid diaphragm distributes the lateral loads in proportion to the in-plane stiffness of the diaphragm and the relative stiffness of the individual elements of the lateral force resisting system. The in-plane stiffness of a flexible diaphragm is negligible compared to the stiffness of the lateral load resisting system and, therefore, the distribution of lateral forces is independent of the relative stiffness of the individual elements of the lateral force resisting system. In this case, the distribution of lateral forces may be computed in a manner analogous to a series of simple beams spanning between the lateral force resisting system elements.

Diaphragms should be designed for the shear, moment and axial forces resulting from the design loads. The diaphragm response may be considered analogous to a deep beam where the flanges (often referred to as chords of the diaphragm) develop tension and compression forces, and the web resists the shear. The component elements of the diaphragm need to have strength and deformation capacity consistent with assumptions and intended behavior.

10. Design for Ponding

As used in this Specification, ponding refers to the retention of water due solely to the deflection of flat roof framing. The amount of this water is dependent on the flexibility of the framing. Lacking sufficient framing stiffness, the accumulated weight of the water can result in the collapse of the roof. The problem becomes catastrophic when more water causes more deflection, resulting in more room for more water until the roof collapses. Detailed provisions for determining ponding stability and strength are given in Appendix 2.

12. Design for Fire Conditions

Section B3.12 provides the charging language for Appendix 4 on structural design for fire resistance. Qualification testing is an acceptable alternative to design by analysis for providing fire resistance. Qualification testing is addressed in ASCE/SFPE Standard 29 (ASCE, 2008), ASTM E119, and similar documents.

13. Design for Corrosion Effects

Steel members may deteriorate in some service environments. This deterioration may appear either as external corrosion, which would be visible upon inspection, or in undetected changes that would reduce member strength. The designer should recognize these problems by either factoring a specific amount of tolerance for damage into the design or providing adequate protection (for example, coatings or

cathodic protection) and/or planned maintenance programs so that such problems do not occur.

Because the interior of an HSS is difficult to inspect, some concern has been expressed regarding internal corrosion. However, good design practice can eliminate the concern and the need for expensive protection. Corrosion occurs in the presence of oxygen and water. In an enclosed building, it is improbable that there would be sufficient reintroduction of moisture to cause severe corrosion. Therefore, internal corrosion protection is a consideration only in HSS exposed to weather.

In a sealed HSS, internal corrosion cannot progress beyond the point where the oxygen or moisture necessary for chemical oxidation is consumed (AISI, 1970). The oxidation depth is insignificant when the corrosion process must stop, even when a corrosive atmosphere exists at the time of sealing. If fine openings exist at connections, moisture and air can enter the HSS through capillary action or by aspiration due to the partial vacuum that is created if the HSS is cooled rapidly (Blodgett, 1967). This can be prevented by providing pressure-equalizing holes in locations that make it impossible for water to flow into the HSS by gravity.

Situations where conservative practice would recommend an internal protective coating include: (1) open HSS where changes in the air volume by ventilation or direct flow of water is possible; and (2) open HSS subject to a temperature gradient that would cause condensation.

HSS that are filled or partially filled with concrete should not be sealed. In the event of fire, water in the concrete will vaporize and may create pressure sufficient to burst a sealed HSS. Care should be taken to keep water from remaining in the HSS during or after construction, since the expansion caused by freezing can create pressure that is sufficient to burst an HSS.

Galvanized HSS assemblies should not be completely sealed because rapid pressure changes during the galvanizing process tend to burst sealed assemblies.

B4. MEMBER PROPERTIES

1. Classification of Sections for Local Buckling

Cross sections with a limiting width-to-thickness ratio, λ , greater than those provided in Table B4.1 are subject to local buckling limit states. For the 2010 *Specification for Structural Steel Buildings*, Table B4.1 was separated into two parts: B4.1a for compression members and B4.1b for flexural members. Separation of Table B4.1 into two parts reflects the fact that compression members are only categorized as either slender or nonslender, while flexural members may be slender, noncompact or compact. In addition, separation of Table B4.1 into two parts clarifies ambiguities in λ_r . The width-to-thickness ratio, λ_r , may be different for columns and beams, even for the same element in a cross section, reflecting both the underlying stress state of the connected elements, and the different design methodologies between columns (Chapter E and Appendix 1) and beams (Chapter F and Appendix 1).

Limiting Width-to-Thickness Ratios for Compression Elements in Members Subject to Axial Compression. Compression members containing any elements

with width-to-thickness ratios greater than λ_r provided in Table B4.1a are designated as slender and are subject to the local buckling reductions detailed in Section E7 of the Specification. Nonslender compression members (all elements having width-to-thickness ratio $\leq \lambda_r$) are not subject to local buckling reductions.

Flanges of Built-Up I-Shaped Sections. In the 1993 *LRFD Specification for Structural Steel Buildings* (AISC, 1993), for built-up I-shaped sections under axial compression (Case 2 in Table B4.1a), modifications were made to the flange local buckling criterion to include web-flange interaction. The k_c in the λ_r limit is the same as that used for flexural members. Theory indicates that the web-flange interaction in axial compression is at least as severe as in flexure. Rolled shapes are excluded from this provision because there are no standard sections with proportions where the interaction would occur at commonly available yield stresses. In built-up sections where the interaction causes a reduction in the flange local buckling strength, it is likely that the web is also a thin stiffened element. The k_c factor accounts for the interaction of flange and web local buckling demonstrated in experiments reported in Johnson (1985). The maximum limit of 0.76 corresponds to $F_{cr} = 0.69E/\lambda^2$ which was used as the local buckling strength in earlier editions of both the ASD and LRFD Specifications. An $h/t_w = 27.5$ is required to reach $k_c = 0.76$. Fully fixed restraint for an unstiffened compression element corresponds to $k_c = 1.3$ while zero restraint gives $k_c = 0.42$. Because of web-flange interactions it is possible to get $k_c < 0.42$ from the k_c formula. If $h/t_w > 5.70\sqrt{E/F_y}$, use $h/t_w = 5.70\sqrt{E/F_y}$ in the k_c equation, which corresponds to the 0.35 limit.

Rectangular HSS in Compression. The limits for rectangular HSS walls in uniform compression (Case 6 in Table B4.1a) have been used in AISC Specifications since 1969. They are based on Winter (1968), where adjacent stiffened compression elements in box sections of uniform thickness were observed to provide negligible torsional restraint for one another along their corner edges.

Round HSS in Compression. The λ_r limit for round HSS in compression (Case 9 in Table B4.1a) was first used in the 1978 *Specification for the Design, Fabrication, and Erection of Structural Steel for Buildings* (AISC, 1978). It was recommended in Schilling (1965) based upon research reported in Winter (1968). The same limit was also used to define a compact shape in bending in the 1978 *Specification*. Excluding the use of round HSS with $D/t > 0.45E/F_y$ was also recommended in Schilling (1965). However, following the SSRC recommendations (Ziemian, 2010) and the approach used for other shapes with slender compression elements, a Q factor is used in Section E7 for round sections to account for interaction between local and column buckling. The Q factor is the ratio between the local buckling stress and the yield stress. The local buckling stress for the round section is taken from AISI provisions based on *inelastic action* (Winter, 1970) and is based on tests conducted on fabricated and manufactured cylinders. Subsequent tests on fabricated cylinders (Ziemian, 2010) confirm that this equation is conservative.

Limiting Width-to-Thickness Ratios for Compression Elements in Members Subject to Flexure. Flexural members containing compression elements, all with width-to-thickness ratios less than or equal to λ_p as provided in Table B4.1b, are designated as compact. Compact sections are capable of developing a fully plastic stress

distribution and they possess a rotation capacity of approximately 3 before the onset of local buckling (Yura et al., 1978). Flexural members containing any compression element with width-to-thickness ratios greater than λ_p , but still with all compression elements having width-to-thickness ratios less than or equal to λ_r , are designated as noncompact. Noncompact sections can develop partial yielding in compression elements before local buckling occurs, but will not resist inelastic local buckling at the strain levels required for a fully plastic stress distribution. Flexural members containing any compression elements with width-to-thickness ratios greater than λ_r are designated as slender. Slender-element sections have one or more compression elements that will buckle elastically before the yield stress is achieved. Noncompact and slender-element sections are subject to flange local buckling and/or web local buckling reductions as provided in Chapter F and summarized in Table User Note F1.1, or in Appendix 1.

The values of the limiting ratios, λ_p and λ_r , specified in Table B4.1b are similar to those in the 1989 *Specification for Structural Steel Buildings—Allowable Stress Design and Plastic Design* (AISC, 1989) and Table 2.3.3.3 of Galambos (1978), except that $\lambda_p = 0.38\sqrt{E/F_y}$, limited in Galambos (1978) to determinate beams and to indeterminate beams when moments are determined by elastic analysis, was adopted for all conditions on the basis of Yura et al. (1978). For greater inelastic rotation capacities than provided by the limiting value of λ_p given in Table B4.1b, and/or for structures in areas of high seismicity, see Chapter D and Table D1.1 of the *AISC Seismic Provisions for Structural Steel Buildings* (AISC, 2010b).

Webs in Flexure. In the 2010 *Specification for Structural Steel Buildings*, formulas for λ_p were added as Case 16 in Table B4.1b for I-shaped beams with unequal flanges based on White (2003).

Rectangular HSS in Flexure. The λ_p limit for compact sections is adopted from the *Limit States Design of Steel Structures* (CSA, 2009). Lower values of λ_p are specified for high-seismic design in the *Seismic Provisions for Structural Steel Buildings* based upon tests (Lui and Goel, 1987) that have shown that rectangular HSS braces subjected to reversed axial load fracture catastrophically under relatively few cycles if a local buckle forms. This was confirmed in tests (Sherman, 1995a) where rectangular HSS braces sustained over 500 cycles when a local buckle did not form, even though general column buckling had occurred, but failed in less than 40 cycles when a local buckle developed. Since 2005, the λ_p limit for webs in rectangular HSS flexural members (Case 19 in Table B4.1b) has been reduced from $\lambda_p = 3.76\sqrt{E/F_y}$ to $\lambda_p = 2.42\sqrt{E/F_y}$ based on the work of Wilkinson and Hancock (1998, 2002).

Round HSS in Flexure. The λ_p values for round HSS in flexure (Case 20, Table B4.1b) are based on Sherman (1976), Sherman and Tanavde (1984) and Ziemian (2010). Section F8 also limits the D/t ratio for any round section to $0.45E/F_y$. Beyond this, the local buckling strength decreases rapidly, making it impractical to use these sections in building construction.

2. Design Wall Thickness for HSS

ASTM A500/A500M (ASTM, 2007d) tolerances allow for a wall thickness that is not greater than $\pm 10\%$ of the nominal value. Because the plate and strip from which electric-resistance-welded (ERW) HSS are made are produced to a much smaller thickness tolerance, manufacturers in the United States consistently produce ERW HSS with a wall thickness that is near the lower-bound wall thickness limit. Consequently, AISC and the Steel Tube Institute of North America (STI) recommend that 0.93 times the nominal wall thickness be used for calculations involving engineering design properties of ERW HSS. This results in a weight (mass) variation that is similar to that found in other structural shapes. Submerged-arc-welded (SAW) HSS are produced with a wall thickness that is near the nominal thickness and require no such reduction. The design wall thickness and section properties based upon this reduced thickness have been tabulated in AISC and STI publications since 1997.

3. Gross and Net Area Determination

3a. Gross Area

Gross area is the total area of the cross section without deductions for holes or ineffective portions of elements subject to local buckling.

3b. Net Area

The net area is based on net width and load transfer at a particular chain. Because of possible damage around a hole during drilling or punching operations, $1/16$ in. (1.5 mm) is added to the nominal hole diameter when computing the net area.

CHAPTER C

DESIGN FOR STABILITY

Design for stability is the combination of analysis to determine the required strengths of components and proportioning of components to have adequate available strengths. Various methods are available to provide for stability (Ziemian, 2010).

Chapter C addresses the stability design requirements for steel buildings and other structures. It is based upon the direct analysis method, which can be used in all cases. The effective length method and first-order analysis method are addressed in Appendix 7 as alternative methods of design for stability, and can be used when the limits in Appendix Sections 7.2.1 and 7.3.1, respectively, are satisfied. Other approaches, including design using second-order inelastic or plastic analysis are permitted provided the general requirements in Section C1 are met. Additional provisions for design by inelastic analysis are provided in Appendix 1. Elastic structural analysis by itself is not sufficient to assess stability because the analysis and the equations for component strengths are inextricably interdependent.

C1. GENERAL STABILITY REQUIREMENTS

There are many parameters and behavioral effects that influence the stability of steel-framed structures (Birnstiel and Iffland, 1980; McGuire, 1992; White and Chen, 1993; ASCE Task Committee on Effective Length, 1997; Ziemian, 2010). The stability of structures and individual elements must be considered from the standpoint of the structure as a whole, including not only the compression members, but also the beams, bracing systems and connections.

Stiffness requirements for control of seismic drift are included in many building codes that prohibit *sidesway* amplification ($\Delta_{2nd-order}/\Delta_{1st-order}$ or B_2), calculated with nominal stiffness, from exceeding approximately 1.5 to 1.6 (ICC, 2009). This limit usually is well within the more general recommendation that sidesway amplification, calculated with reduced stiffness, should be equal to or less than 2.5. The latter recommendation is made because at larger levels of amplification, small changes in gravity loads and/or structural stiffness can result in relatively larger changes in sidesway deflections and second-order effects, due to large geometric nonlinearities.

Table C-C1.1 shows how the five general requirements provided in Section C1 are addressed in the direct analysis method (Sections C2 and C3) and the effective length method (Appendix 7, Section 7.2). The first-order analysis method (Appendix 7, Section 7.3) is not included in Table C-C1.1 because it addresses these requirements in an indirect manner using a mathematical manipulation of the direct analysis method. The additional lateral load required in Appendix 7, Section 7.3.2(1) is calibrated to achieve roughly the same result as the collective effects of the notional load required in Section C2.2b, a B_2 multiplier for P - Δ effects required in Section C2.1(2), and the stiffness reduction required in Section C2.3. Additionally, a B_1 multiplier addresses P - δ effects as required in Appendix 7, Section 7.3.2(2).

TABLE C-C1.1
Comparison of Basic Stability Requirements
with Specific Provisions

Basic Requirement in Section C1		Provision in Direct Analysis Method (DM)	Provision in Effective Length Method (ELM)
(1) Consider all deformations		C2.1(1). Consider all deformations	Same as DM (by reference to C2.1)
(2) Consider second-order effects (both $P-\Delta$ and $P-\delta$)		C2.1(2). Consider second-order effects ($P-\Delta$ and $P-\delta$)**	Same as DM (by reference to C2.1)
(3) Consider geometric imperfections <i>This includes joint-position imperfections* (which affect structure response) and member imperfections (which affect structure response and member strength)</i>	Effect of joint-position imperfections* on structure response	C2.2a. Direct modeling or C2.2b. Notional loads	Same as DM, second option only (by reference to C2.2b)
	Effect of member imperfections on structure response	Included in the stiffness reduction specified in C2.3	
	Effect of member imperfections on member strength	Included in member strength formulas, with $KL = L$	
(4) Consider stiffness reduction due to inelasticity <i>This affects structure response and member strength</i>	Effect of stiffness reduction on structure response	Included in the stiffness reduction specified in C2.3	<ul style="list-style-type: none"> • DM uses reduced stiffness in the analysis; $KL = L$ in the member strength check • ELM uses full stiffness in the analysis; KL from sidesway buckling analysis in the member strength check for frame members
	Effect of stiffness reduction on member strength	Included in member strength formulas, with $KL = L$	
(5) Consider uncertainty in strength and stiffness <i>This affects structure response and member strength</i>	Effect of stiffness/strength uncertainty on structure response	Included in the stiffness reduction specified in C2.3	
	Effect of stiffness/strength uncertainty on member strength	Included in member strength formulas, with $KL = L$	
<p>* In typical building structures, the "joint-position imperfections" refers to column out-of-plumbness. ** Second-order effects may be considered either by rigorous second-order analysis or by the approximate technique (using B_1 and B_2) specified in Appendix 8.</p>			

C2. CALCULATION OF REQUIRED STRENGTHS

Analysis to determine required strengths in accordance with this Section and the assessment of member and connection available strengths in accordance with Section C3 form the basis of the direct analysis method of design for stability. This method is useful for the stability design of all structural steel systems, including moment frames, braced frames, shear walls, and combinations of these and similar systems (AISC-SSRC, 2003b). While the precise formulation of this method is

unique to the AISC Specification, some of its features have similarities to other major design specifications around the world, including the Eurocodes, the Australian standard, the Canadian standard, and ACI 318 (ACI, 2008).

The direct analysis method allows a more accurate determination of the load effects in the structure through the inclusion of the effects of geometric imperfections and stiffness reductions directly within the structural analysis. This also allows the use of $K = 1.0$ in calculating the in-plane column strength, P_c , within the beam-column interaction equations of Chapter H. This is a significant simplification in the design of steel moment frames and combined systems.

1. General Analysis Requirements

Deformations to be Considered in the Analysis. It is required that the analysis consider flexural, shear and axial deformations, and all other component and connection deformations that contribute to the displacement of the structure. However, it is important to note that “consider” is not synonymous with “include,” and some deformations can be neglected after rational consideration of their likely effect. For example, the in-plane deformation of a concrete-on-steel deck floor diaphragm in an office building usually can be neglected, but that of a cold-formed steel roof deck in a large warehouse with widely spaced lateral-load-resisting elements usually cannot. As another example, shear deformations in beams and columns in a low-rise moment frame usually can be neglected, but this may not be true in a high-rise framed-tube system.

Second-Order Effects. The direct analysis method includes the basic requirement to calculate the internal load effects using a second-order analysis that accounts for both $P-\Delta$ and $P-\delta$ effects (see Figure C-C2.1). $P-\Delta$ effects are the effects of loads acting on the displaced location of joints or nodes in a structure. $P-\delta$ effects are the effect of loads acting on the deflected shape of a member between joints or nodes.

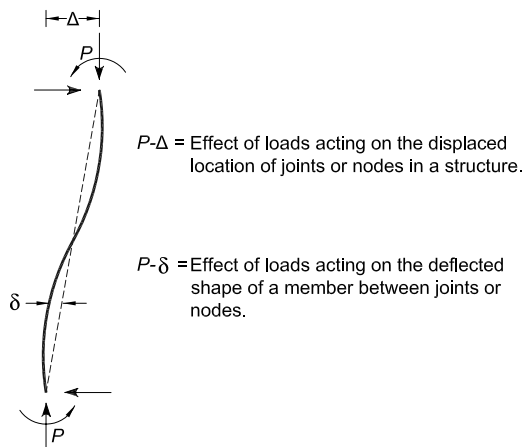

Fig. C-C2.1. $P-\Delta$ and $P-\delta$ effects in beam-columns.

Rigorous second-order analyses are those that accurately model all significant second-order effects. One such approach is the solution of the governing differential equation, either through stability functions or computer frame analysis programs that model these effects (McGuire et al., 2000; Ziemian, 2010). Some—but not all, and possibly not even most—modern commercial computer programs are capable of performing a rigorous second-order analysis, although this should be verified by the user for each particular program. The effect of neglecting $P-\delta$ in the analysis of the structure, a common approximation that is permitted under certain conditions, is discussed at the end of this section.

Methods that modify first-order analysis results through second-order amplifiers are permitted as an alternative to a rigorous analysis. The use of the B_1 and B_2 amplifiers provided in Appendix 8 is one such method. The accuracy of other methods should be verified.

Analysis Benchmark Problems. The following benchmark problems are recommended as a first-level check to determine whether an analysis procedure meets the requirements of a rigorous second-order analysis adequate for use in the direct analysis method (and the effective length method in Appendix 7). Some second-order analysis procedures may not include the effects of $P-\delta$ on the overall response of the structure. These benchmark problems are intended to reveal whether or not these effects are included in the analysis. It should be noted that per the requirements of Section C2.1(2), it is not always necessary to include $P-\delta$ effects in the second-order analysis (additional discussion of the consequences of neglecting these effects appears below).

The benchmark problem descriptions and solutions are shown in Figures C-C2.2 and C-C2.3. Case 1 is a simply supported beam-column subjected to an axial load concurrent with a uniformly distributed transverse load between supports. This problem contains only $P-\delta$ effects because there is no translation of one end of the member relative to the other. Case 2 is a fixed-base cantilevered beam-column subjected to an axial load concurrent with a lateral load at its top. This problem contains both $P-\Delta$ and $P-\delta$ effects. In confirming the accuracy of the analysis method, both moments and deflections should be checked at the locations shown for the various levels of axial load on the member and in all cases should agree within 3% and 5%, respectively.

Given that there are many attributes that must be studied to confirm the accuracy of a given analysis method for routine use in the design of general framing systems, a wide range of benchmark problems should be employed. Several other targeted analysis benchmark problems can be found in Kaehler et al. (2010), Chen and Lui (1987), and McGuire et al. (2000). When using benchmark problems to assess the correctness of a second-order procedure, the details of the analysis used in the benchmark study, such as the number of elements used to represent the member and the numerical solution scheme employed, should be replicated in the analysis used to design the actual structure. Because the ratio of design load to elastic buckling load is a strong indicator of the influence of second-order effects, benchmark problems with such ratios on the order of 0.6 to 0.7 should be included.

Effect of Neglecting $P-\delta$. A common type of approximate analysis is one that captures only $P-\Delta$ effects due to member end translations (for example, *interstory drift*) but fails to capture $P-\delta$ effects due to curvature of the member relative to its chord. This type of analysis is referred to as a $P-\Delta$ analysis. Where $P-\delta$ effects are significant, errors arise in approximate methods that do not accurately account for the effect of $P-\delta$ moments on amplification of both local (δ) and global (Δ) displacements and corresponding internal moments. These errors can occur both with second-order computer analysis programs and with the B_1 and B_2 amplifiers. For instance, the R_M modifier in Equation A-8-7 is an adjustment factor that approximates the effects of $P-\delta$ (due to column curvature) on the overall sidesway displacements, Δ , and the corresponding moments. For regular rectangular moment frames, a single-element-per-member $P-\Delta$ analysis is equivalent to using the B_2 amplifier of Equation A-8-6 with $R_M = 1$, and hence, such an analysis neglects the effect of $P-\delta$ on the response of the structure.

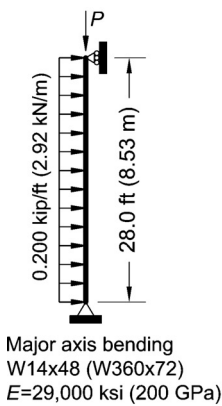

Axial Force, P (kips)	0	150	300	450
M_{mid} (kip-in.)	235 [235]	270 [269]	316 [313]	380 [375]
Δ_{mid} (in.)	0.202 [0.197]	0.230 [0.224]	0.269 [0.261]	0.322 [0.311]

Axial Force, P (kN)	0	667	1334	2001
M_{mid} (kN-m)	26.6 [26.6]	30.5 [30.4]	35.7 [35.4]	43.0 [42.4]
Δ_{mid} (mm)	5.13 [5.02]	5.86 [5.71]	6.84 [6.63]	8.21 [7.91]

Analyses include axial, flexural and shear deformations.
[Values in brackets] exclude shear deformations.

Fig. C-C2.2. Benchmark problem Case 1.

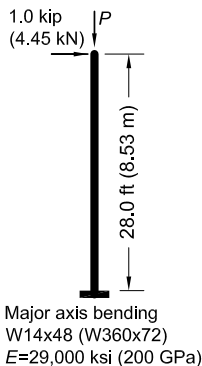

Axial Force, P (kips)	0	100	150	200
M_{base} (kip-in.)	336 [336]	470 [469]	601 [598]	856 [848]
Δ_{tip} (in.)	0.907 [0.901]	1.34 [1.33]	1.77 [1.75]	2.60 [2.56]

Axial Force, P (kN)	0	445	667	890
M_{base} (kN-m)	38.0 [38.0]	53.2 [53.1]	68.1 [67.7]	97.2 [96.2]
Δ_{tip} (mm)	23.1 [22.9]	34.2 [33.9]	45.1 [44.6]	66.6 [65.4]

Analyses include axial, flexural and shear deformations.
[Values in brackets] exclude shear deformations.

Fig. C-C2.3. Benchmark problem Case 2.

Section C2.1(2) indicates that a P - Δ -only analysis (one that neglects the effect of P - δ deformations on the response of the structure) is permissible for typical building structures when the ratio of second-order drift to first-order drift is less than 1.7 and no more than one-third of the total gravity load on the building is on columns that are part of moment-resisting frames. The latter condition is equivalent to an R_M value of 0.95 or greater. When these conditions are satisfied, the error in lateral displacement from a P - Δ -only analysis typically will be less than 3%. However, when the P - δ effect in one or more members is large (corresponding to a B_1 multiplier of more than about 1.2), use of a P - Δ -only analysis may lead to larger errors in the nonsway moments in components connected to the high- P - δ members.

The engineer should be aware of this possible error before using a P - Δ -only analysis in such cases. For example, consider the evaluation of the fixed-base cantilevered beam-column shown in Figure C-C2.4 using the direct analysis method. The side-sway displacement amplification factor is 3.83 and the base moment amplifier is 3.32, giving $M_u = 1,394$ kip-in.

For the loads shown, the beam-column strength interaction according to Equation H1-1a is equal to 1.0. The sidesway displacement and base moment amplification determined by a single-element P - Δ analysis, which ignores the effect of P - δ on the response of the structure, is 2.55, resulting in an estimated $M_u = 1,070$ kip-in.—an error of 23.2% relative to the more accurate value of M_u —and a beam-column interaction value of 0.91.

P - δ effects can be captured in some (but not all) P - Δ -only analysis methods by subdividing the members into multiple elements. For this example, three equal-length P - Δ analysis elements are required to reduce the errors in the second-order base moment and sidesway displacement to less than 3% and 5%, respectively.

It should be noted that in this case the unconservative error that results from ignoring the effect of P - δ on the response of the structure is removed through the use of Equation A-8-8. For the loads shown in Figure C-C2.4, Equations A-8-6 and A-8-7

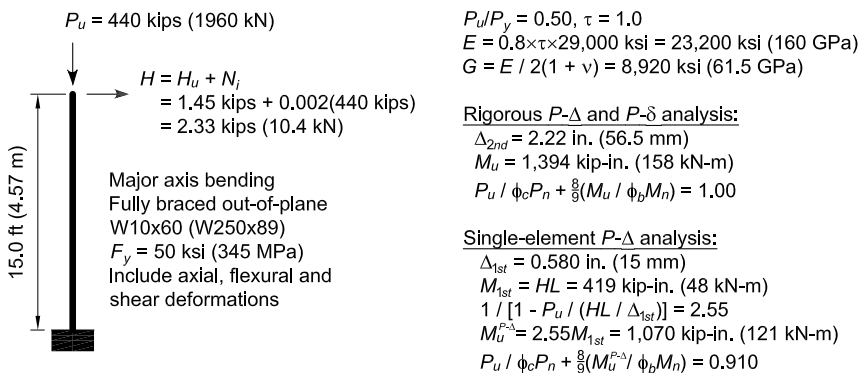

Fig. C-C2.4. Illustration of potential errors associated with the use of a single-element-per-member P - Δ analysis.

with $R_M = 0.85$ gives a B_2 amplifier of 3.52. This corresponds to $M_u = 1,476$ kip-in. (166×10^6 N-mm) in the preceding example, approximately 6% over that determined from a rigorous second order analysis.

For sway columns with nominally simply supported base conditions, the errors in the second-order internal moment and in the second-order displacements from a P - Δ -only analysis are generally smaller than 3% and 5%, respectively, when $\alpha P_r/P_{eL} \leq 0.05$,

where

$$\alpha = 1.00 \text{ (LRFD)}$$

$$= 1.60 \text{ (ASD)}$$

P_r = required axial force, ASD or LRFD, kips (N)

$P_{eL} = \pi^2 EI/L^2$ if the analysis uses nominal stiffness, kips (N)

$P_{eL} = 0.8\tau_b \pi^2 EI/L^2$, kips (N), if the analysis uses a flexural stiffness reduction of $0.8\tau_b$

For sway columns with rotational restraint at both ends of at least $1.5(EI/L)$ if the analysis uses nominal stiffness or $1.5(0.8\tau_b EI/L)$ if the analysis uses a flexural stiffness reduction of $0.8\tau_b$, the errors in the second-order internal moments and displacements from a P - Δ -only analysis are generally smaller than 3% and 5%, respectively, when $\alpha P_r/P_{eL} \leq 0.12$.

For members subjected predominantly to nonsway end conditions, the errors in the second-order internal moments and displacements from a P - Δ -only analysis are generally smaller than 3% and 5%, respectively, when $\alpha P_r/P_{eL} \leq 0.05$.

In meeting the above limitations for use of a P - Δ -only analysis, it is important to note that per Section C2.1(2) the moments along the length of member (i.e., the moments between the member-end nodal locations) should be amplified as necessary to include P - δ effects. One device for achieving this is the use of a B_1 factor.

Kaehler et al. (2010) provide further guidelines for the appropriate number of P - Δ analysis elements in cases where the above limits are exceeded, as well as guidelines for calculating internal element second-order moments. They also provide relaxed guidelines for the number of elements required per member when using typical second-order analysis capabilities that include both P - Δ and P - δ effects.

As previously indicated, the engineer should verify the accuracy of second-order analysis software by comparisons to known solutions for a range of representative loadings. In addition to the examples presented in Chen and Lui (1987) and McGuire et al. (2000), Kaehler et al. (2010) provides five useful benchmark problems for testing second-order analysis of frames composed of prismatic members. In addition, they provide benchmarks for evaluation of second-order analysis capabilities for web-tapered members.

Analysis at Strength Level. It is essential that the analysis of the frame be made at the strength level because of the nonlinearity associated with second-order effects. For design by ASD, this load level is estimated as 1.6 times the ASD load combinations, and the analysis must be conducted at this elevated load to capture second-order effects at the strength level.

2. Consideration of Initial Imperfections

Modern stability design provisions are based on the premise that the member forces are calculated by second-order elastic analysis, where equilibrium is satisfied on the deformed geometry of the structure. Initial imperfections in the structure, such as out-of-plumbness and material and fabrication tolerances, create destabilizing effects.

In the development and calibration of the direct analysis method, initial geometric imperfections are conservatively assumed equal to the maximum material, fabrication and erection tolerances permitted in the AISC *Code of Standard Practice for Steel Buildings and Bridges* (AISC, 2010a): a member out-of-straightness equal to $L/1000$, where L is the member length between brace or framing points, and a frame out-of-plumbness equal to $H/500$, where H is the story height. The permitted out-of-plumbness may be smaller in some cases, as specified in the AISC *Code of Standard Practice for Steel Buildings and Bridges*.

Initial imperfections can be accounted for in the direct analysis method through direct modeling (Section C2.2a) or the inclusion of notional loads (Section C2.2b). When second-order effects are such that the maximum sidesway amplification $\Delta_{2nd\ order}/\Delta_{1st\ order}$ or $B_2 \leq 1.7$ using the reduced elastic stiffness (or 1.5 using the unreduced elastic stiffness) for all lateral load combinations, it is permitted to apply the notional loads only in the gravity load-only combinations and not in combination with other lateral loads. At this low range of sidesway amplification or B_2 , the errors in internal forces caused by not applying the notional loads in combination with other lateral loads are relatively small. When B_2 is above the threshold, the notional loads must also be applied in combination with other lateral loads.

The Specification requirements for consideration of initial imperfections are intended to apply only to analyses for strength limit states. It is not necessary, in most cases, to consider initial imperfections in analyses for serviceability conditions such as drift, deflection and vibration.

3. Adjustments to Stiffness

Partial yielding accentuated by *residual stresses* in members can produce a general softening of the structure at the strength limit state that further creates destabilizing effects. The direct analysis method is also calibrated against inelastic distributed-plasticity analyses that account for the spread of plasticity through the member cross section and along the member length. The residual stresses in W-shapes are assumed to have a maximum value of $0.3F_y$ in compression at the flange tips, and a distribution matching the so-called Lehigh pattern—a linear variation across the flanges and uniform tension in the web (Ziemian, 2010).

Reduced stiffness ($EI^* = 0.8\tau_b EI$ and $EA^* = 0.8EA$) is used in the direct analysis method for two reasons. First, for frames with slender members, where the limit state is governed by elastic stability, the 0.8 factor on stiffness results in a system available strength equal to 0.8 times the elastic stability limit. This is roughly equivalent to the margin of safety implied in the design provisions for slender columns by the effective length procedure where from Equation E3-3, $\phi P_n = 0.9(0.877P_e) = 0.79P_e$. Second, for frames with intermediate or stocky columns, the $0.8\tau_b$ factor reduces the

stiffness to account for inelastic softening prior to the members reaching their design strength. The τ_b factor is similar to the inelastic stiffness reduction factor implied in the *column curve* to account for loss of stiffness under high compression loads ($\alpha P_r > 0.5P_y$), and the 0.8 factor accounts for additional softening under combined axial compression and bending. It is a fortuitous coincidence that the reduction coefficients for both slender and stocky columns are close enough, such that the single reduction factor of $0.8\tau_b$ works over the full range of slenderness.

The use of reduced stiffness only pertains to analyses for strength and stability limit states. It does not apply to analyses for other stiffness-based conditions and criteria, such as for drift, deflection, vibration and period determination.

For ease of application in design practice, where $\tau_b = 1$, the reduction on EI and EA can be applied by modifying E in the analysis. However, for computer programs that do semi-automated design, one should ensure that the reduced E is applied only for the second-order analysis. The elastic modulus should not be reduced in nominal strength equations that include E (for example, M_n for lateral-torsional buckling in an unbraced beam).

As shown in Figure C-C2.5, the net effect of modifying the analysis in the manner just described is to amplify the second-order forces such that they are closer to the

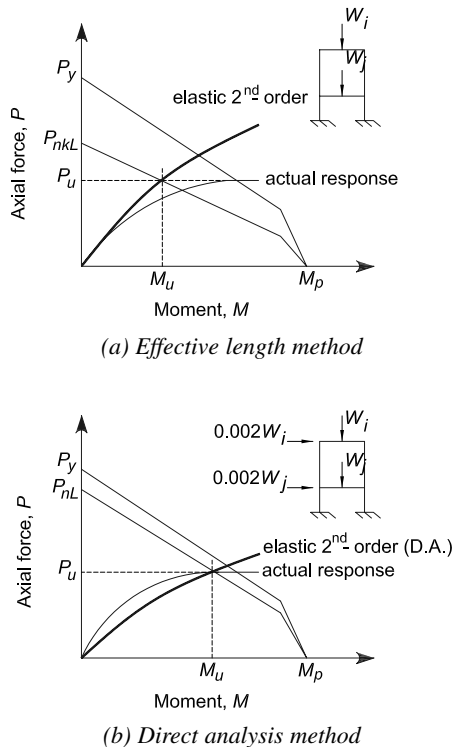

Fig. C-C2.5. Comparison of in-plane beam-column interaction checks for (a) the effective length method and (b) the direct analysis method.

actual internal forces in the structure. It is for this reason that the beam-column interaction for in-plane flexural buckling is checked using an axial strength, P_{nL} , calculated from the *column curve* using the actual unbraced member length, L , in other words, with $K = 1.0$.

In cases where the flexibility of other structural components (connections, column base details, horizontal trusses acting as diaphragms) is modeled explicitly in the analysis, the stiffness of these components also should be reduced. The stiffness reduction may be taken conservatively as $EA^* = 0.8EA$ and/or $EI^* = 0.8EI$ for all cases. Surovek-Maleck et al. (2004) discusses the appropriate reduction of connection stiffness in the analysis of PR frames.

Where concrete shear walls or other nonsteel components contribute to the stability of the structure and the governing codes or standards for those elements specify a greater stiffness reduction, the greater reduction should be applied.

C3. CALCULATION OF AVAILABLE STRENGTHS

Section C3 provides that when the analysis meets the requirements in Section C2, the member provisions for available strength in Chapters E through I and connection provisions in Chapters J and K complete the process of design by the direct analysis method. The *effective length factor*, K , can be taken as unity for all members in the strength checks.

Where beams and columns rely upon braces that are not part of the lateral-load-resisting system to define their unbraced length, the braces themselves must have sufficient strength and stiffness to control member movement at the brace points (see Appendix 6). Design requirements for braces that are part of the lateral-load-resisting system (that is, braces that are included within the analysis of the structure) are addressed within Chapter C.

For beam-columns in single-axis flexure and compression, the analysis results from the direct analysis method may be used directly with the interaction equations in Section H1.3, which address in-plane flexural buckling and out-of-plane lateral-torsional instability separately. These separated interaction equations reduce the conservatism of the Section H1.1 provisions, which combine the two limit state checks into one equation that uses the most severe combination of in-plane and out-of-plane limits for P_r/P_c and M_r/M_c . A significant advantage of the direct analysis method is that the in-plane check with P_c in the interaction equation is determined using $K = 1.0$.

CHAPTER D

DESIGN OF MEMBERS FOR TENSION

The provisions of Chapter D do not account for eccentricities between the lines of action of connected assemblies.

D1. SLENDERNESS LIMITATIONS

The advisory upper limit on slenderness in the User Note is based on professional judgment and practical considerations of economics, ease of handling, and care required so as to minimize inadvertent damage during fabrication, transport and erection. This slenderness limit is not essential to the structural integrity of tension members; it merely assures a degree of stiffness such that undesirable lateral movement (“slapping” or vibration) will be unlikely. Out-of-straightness within reasonable tolerances does not affect the strength of tension members. Applied tension tends to reduce, whereas compression tends to amplify, out-of-straightness.

For single angles, the radius of gyration about the z -axis produces the maximum L/r and, except for very unusual support conditions, the maximum KL/r .

D2. TENSILE STRENGTH

Because of *strain hardening*, a ductile steel bar loaded in axial tension can resist without rupture a force greater than the product of its gross area and its specified minimum yield stress. However, excessive elongation of a tension member due to uncontrolled yielding of its gross area not only marks the limit of its usefulness but can precipitate failure of the structural system of which it is a part. On the other hand, depending upon the reduction of area and other mechanical properties of the steel, the member can fail by rupture of the net area at a load smaller than required to yield the gross area. Hence, general yielding of the gross area and rupture of the net area both constitute limit states.

The length of the member in the net area is generally negligible relative to the total length of the member. Strain hardening is easily reached in the vicinity of holes and yielding of the net area at fastener holes does not constitute a limit state of practical significance.

Except for HSS that are subjected to *cyclic load* reversals, there is no information that the factors governing the strength of HSS in tension differ from those for other structural shapes, and the provisions in Section D2 apply. Because the number of different end connection types that are practical for HSS is limited, the determination of the effective net area, A_e , can be simplified using the provisions in Chapter K.

D3. EFFECTIVE NET AREA

Section D3 deals with the effect of shear lag, applicable to both welded and bolted tension members. Shear lag is a concept used to account for uneven stress distribu-

tion in connected members where some but not all of their elements (flange, web, leg, etc.) are connected. The reduction coefficient, U , is applied to the net area, A_n , of bolted members and to the gross area, A_g , of welded members. As the length of the connection, l , is increased, the shear lag effect diminishes. This concept is expressed empirically by the equation for U . Using this expression to compute the effective area, the estimated strength of some 1,000 bolted and riveted connection test specimens, with few exceptions, correlated with observed test results within a scatterband of $\pm 10\%$ (Munse and Chesson, 1963). Newer research provides further justification for the current provisions (Easterling and Gonzales, 1993).

For any given profile and configuration of connected elements, \bar{x} is the perpendicular distance from the connection plane, or face of the member, to the centroid of the member section resisting the connection force, as shown in Figure C-D3.1. The length, l , is a function of the number of rows of fasteners or the length of weld. The length, l , is illustrated as the distance, parallel to the line of force, between the first and last row of fasteners in a line for bolted connections. The number of bolts in a line, for the purpose of the determination of l , is determined by the line with the maximum number of bolts in the connection. For staggered bolts, the out-to-out dimension is used for l , as shown in Figure C-D3.2.

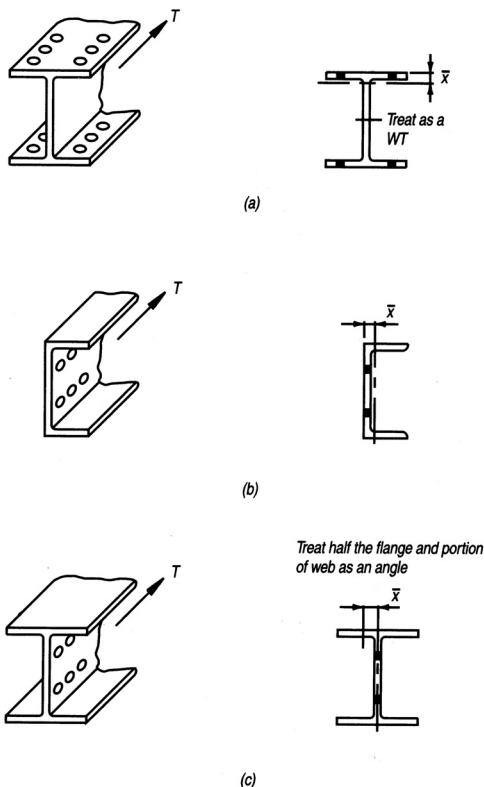

Fig. C-D3.1. Determination of \bar{x} for U .

From the definition of the plastic section modulus, $Z = \sum |A_i d_i|$, where A_i is the area of a cross-sectional element and d_i is the perpendicular distance from the plastic neutral axis to the center of gravity of the element; \bar{x} for cases like that shown on the right hand side of Figure C-D3.1(c) is Z_y/A . Because the section shown is symmetric about the vertical axis and that axis is also the plastic neutral axis, the first moment of the area to the left is $Z_y/2$, where Z_y is the plastic section modulus of the entire section. The area of the left side is $A/2$; therefore, by definition $\bar{x} = Z_y/A$. For the case shown on the right hand side of Figure C-D3.1(b), $\bar{x} = d/2 - Z_x/A$. Note that the plastic neutral axis must be an axis of symmetry for this relationship to apply.

There is insufficient data for establishing a value of U if all lines have only one bolt, but it is probably conservative to use A_e equal to the net area of the connected element. The limit states of block shear (Section J4.3) and bearing (Section J3.10), which must be checked, will probably control the design.

The ratio of the area of the connected element to the gross area is a reasonable lower bound for U and allows for cases where the calculated U based on $(1-\bar{x}/l)$ is very small, or nonexistent, such as when a single bolt per gage line is used and $l = 0$. This lower bound is similar to other design specifications, for example the AASHTO *Standard Specifications for Highway Bridges* (AASHTO, 2002), which allow a U based on the area of the connected portion plus half the gross area of the unconnected portion.

The effect of connection eccentricity is a function of connection and member stiffness and may sometimes need to be considered in the design of the tension connection or member. Historically, engineers have neglected the effect of eccentricity in both the member and the connection when designing tension-only bracing. In Cases 1a and 1b shown in Figure C-D3.3, the length of the connection required to resist the axial loads will usually reduce the applied axial load on the bolts to a negligible value. For Case 2, the flexibility of the member and the connections will allow the member to deform such that the resulting eccentricity is relieved to a considerable extent.

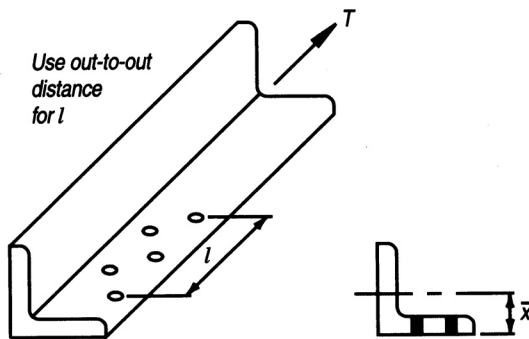

Fig. C-D3.2. Determination of l for U of bolted connections with staggered holes.

For welded connections, l is the length of the weld parallel to the line of force as shown in Figure C-D3.4 for longitudinal and longitudinal plus transverse welds. For welds with unequal lengths, use the average length.

End connections for HSS in tension are commonly made by welding around the perimeter of the HSS; in this case, there is no shear lag or reduction in the gross area.

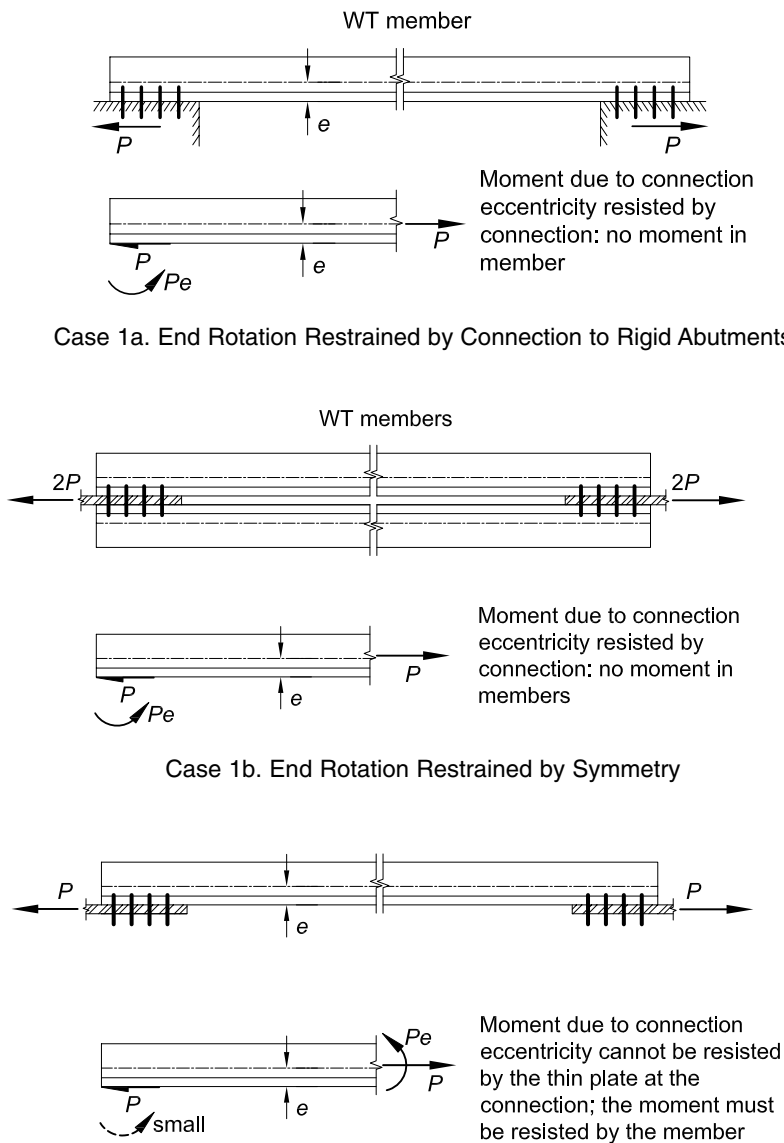

Fig. C-D3.3. The effect of connection restraint on eccentricity.

Alternatively, an end connection with gusset plates can be used. Single gusset plates may be welded in longitudinal slots that are located at the centerline of the cross section. Welding around the end of the gusset plate may be omitted for statically loaded connections to prevent possible *undercutting* of the gusset and having to bridge the gap at the end of the slot. In such cases, the net area at the end of the slot is the critical area as illustrated in Figure C-D3.5. Alternatively, a pair of gusset plates can be welded to opposite sides of a rectangular HSS with flare bevel groove welds with no reduction in the gross area.

For end connections with gusset plates, the general provisions for shear lag in Case 2 of Table D3.1 can be simplified and the connection eccentricity can be explicitly defined as in Cases 5 and 6. In Cases 5 and 6 it is implied that the weld length, l , should not be less than the depth of the HSS. This is consistent with the weld length requirements in Case 4. In Case 5, the use of $U = 1$ when $l \geq 1.3D$ is based on research (Cheng and Kulak, 2000) that shows rupture occurs only in short connections and in long connections the round HSS tension member necks within its length and failure is by member yielding and eventual rupture.

The shear lag factors given in Cases 7 and 8 of Table D3.1 are given as alternate U values to the value determined from $1 - \bar{x} / l$ given for Case 2 in Table D3.1. It is permissible to use the larger of the two values.

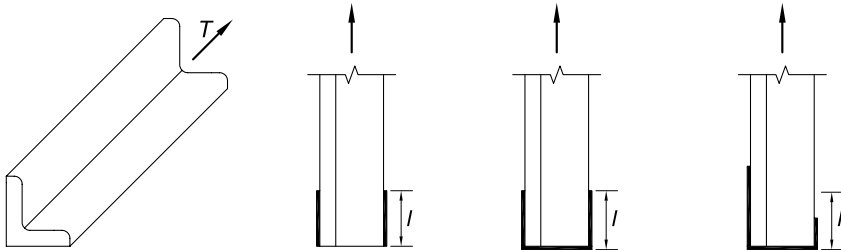

Fig. C-D3.4. Determination of l for calculation of U for connections with longitudinal and transverse welds.

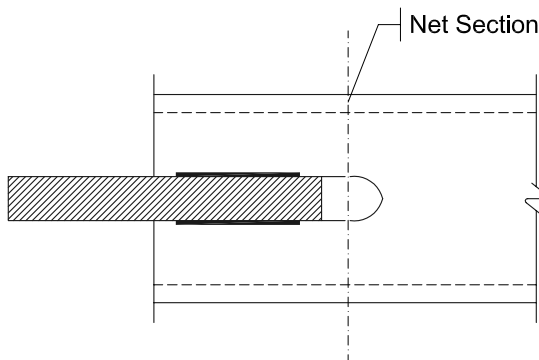

Fig. C-D3.5. Net area through slot for a single gusset plate.

D4. BUILT-UP MEMBERS

Although not commonly used, built-up member configurations using lacing, tie plates and perforated cover plates are permitted by this Specification. The length and thickness of tie plates are limited by the distance between the lines of fasteners, h , which may be either bolts or welds.

D5. PIN-CONNECTED MEMBERS

Pin-connected members are occasionally used as tension members with very large dead loads. Pin-connected members are not recommended when there is sufficient variation in live loading to cause wearing of the pins in the holes. The dimensional requirements presented in Specification Section D5.2 must be met to provide for the proper functioning of the pin.

1. Tensile Strength

The tensile strength requirements for pin-connected members use the same ϕ and Ω values as elsewhere in this Specification for similar limit states. However, the definitions of effective net area for tension and shear are different.

2. Dimensional Requirements

Dimensional requirements for pin-connected members are illustrated in Figure C-D5.1.

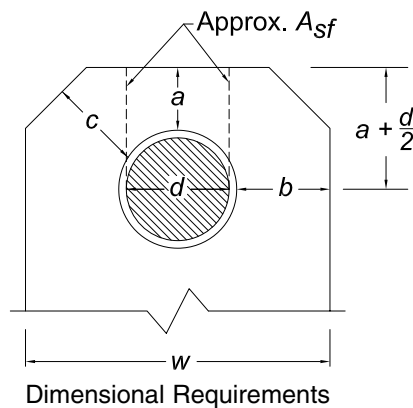

1. $a \geq 1.33 b_e$
2. $w \geq 2b_e + d$
3. $c \geq a$

where

$$b_e = 2t + 0.63 \text{ in. (16 mm)} \leq b$$

Fig. C-D5.1. Dimensional requirements for pin-connected members.

D6. EYEBARS

Forged eyebars have generally been replaced by pin-connected plates or eyebars thermally cut from plates. Provisions for the proportioning of eyebars contained in this Specification are based upon standards evolved from long experience with forged eyebars. Through extensive destructive testing, eyebars have been found to provide balanced designs when they are thermally cut instead of forged. The more conservative rules for pin-connected members of nonuniform cross section and for members not having enlarged “circular” heads are likewise based on the results of experimental research (Johnston, 1939).

Stockier proportions are required for eyebars fabricated from steel having a yield stress greater than 70 ksi (485 MPa) to eliminate any possibility of their “dishing” under the higher design stress.

1. Tensile Strength

The tensile strength of eyebars is determined as for general tension members, except that, for calculation purposes, the width of the body of the eyebar is limited to eight times its thickness.

2. Dimensional Requirements

Dimensional limitations for eyebars are illustrated in Figure C-D6.1. Adherence to these limits assures that the controlling limit state will be tensile yielding of the body; thus, additional limit state checks are unnecessary.

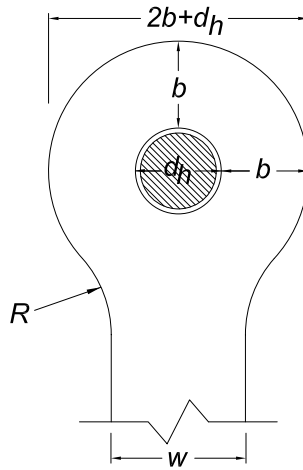

Dimensional Requirements

$t \geq 1/2$ in. (13 mm) (Exception is provided in Section D6.2)

$$w \leq 8t$$

$$d \geq 7/8w$$

$$d_h \leq d + 1/32 \text{ in. (1 mm)}$$

$$R \geq d_h + 2b$$

$$2/3w \leq b \leq 3/4w \text{ (Upper limit is for calculation purposes only)}$$

Fig. C-D6.1. Dimensional limitations for eyebars.

CHAPTER E

DESIGN OF MEMBERS FOR COMPRESSION

E1. GENERAL PROVISIONS

The column equations in Section E3 are based on a conversion of the research data into strength equations (Ziemian, 2010; Tide, 1985, 2001). These equations are the same as those in the 2005 AISC *Specification for Structural Steel Buildings* (AISC, 2005a) and are essentially the same as those in the previous editions of the LRFD Specification (AISC, 1986, 1993, 2000b). The resistance factor, ϕ , was increased from 0.85 to 0.90 in the 2005 Specification, recognizing substantial numbers of additional column strength analyses and test results, combined with the changes in industry practice that had taken place since the original calibrations were performed in the 1970s and 1980s.

In the original research on the probability-based strength of steel columns (Bjorhovde, 1972, 1978, 1988), three *column curves* were recommended. The three column curves were the approximate means of bands of strength curves for columns of similar manufacture, based on extensive analyses and confirmed by full-scale tests (Bjorhovde, 1972). For example, hot-formed and cold-formed heat treated HSS columns fell into the data band of highest strength [SSRC Column Category 1P (Bjorhovde, 1972, 1988; Bjorhovde and Birkemoe, 1979; Ziemian, 2010)], while welded built-up wide-flange columns made from universal mill plates were included in the data band of lowest strength (SSRC Column Category 3P). The largest group of data clustered around SSRC Column Category 2P. Had the original LRFD Specification opted for using all three column curves for the respective column categories, probabilistic analysis would have resulted in a resistance factor $\phi = 0.90$ or even slightly higher (Galambos, 1983; Bjorhovde, 1988; Ziemian, 2010). However, it was decided to use only one column curve, SSRC Column Category 2P, for all column types. This resulted in a larger data spread and thus a larger coefficient of variation, and so a resistance factor $\phi = 0.85$ was adopted for the column equations to achieve a level of reliability comparable to that of beams. Since that time, significant additional analyses and tests, as well as changes in practice, have demonstrated that the increase to 0.90 was warranted, indeed even somewhat conservative (Bjorhovde, 1988).

The single column curve and the resistance factor of 0.85 were selected by the AISC Committee on Specifications in 1981 when the first draft of the LRFD Specification was developed (AISC, 1986). Since then a number of changes in industry practice have taken place: (1) welded built-up shapes are no longer manufactured from universal mill plates; (2) the most commonly used structural steel is now ASTM A992, with a specified minimum yield stress of 50 ksi (345 MPa); and (3) changes in steel-making practice have resulted in materials of higher quality and much better defined properties. The level and variability of the yield stress thus have led to a reduced coefficient of variation for the relevant material properties (Bartlett et al., 2003).

An examination of the SSRC Column Curve Selection Table (Bjorhovde, 1988; Ziemian, 2010) shows that the SSRC 3P Column Curve Category is no longer needed. It is now possible to use only the statistical data for SSRC Column Category 2P for the probabilistic determination of the reliability of columns. The curves in Figures C-E1.1 and C-E1.2 show the variation of the reliability index β with the live-to-dead load ratio, L/D , in the range of 1 to 5 for LRFD with $\phi = 0.90$ and ASD with

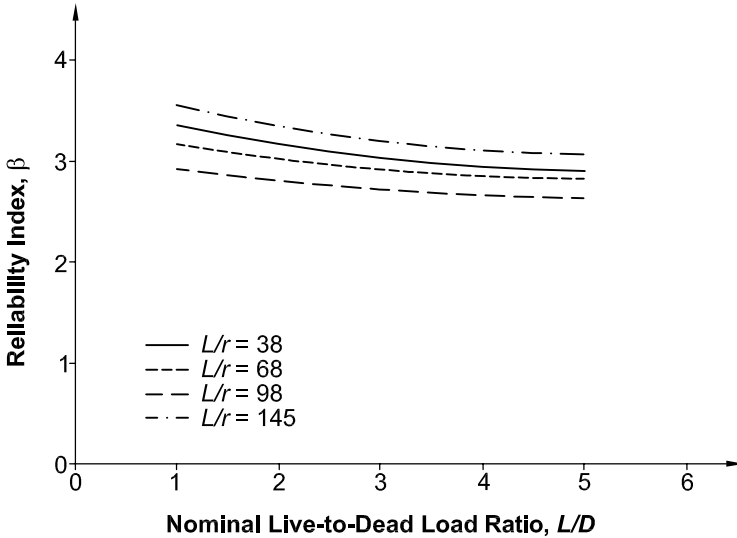

Fig. C-E1.1. Reliability of columns (LRFD).

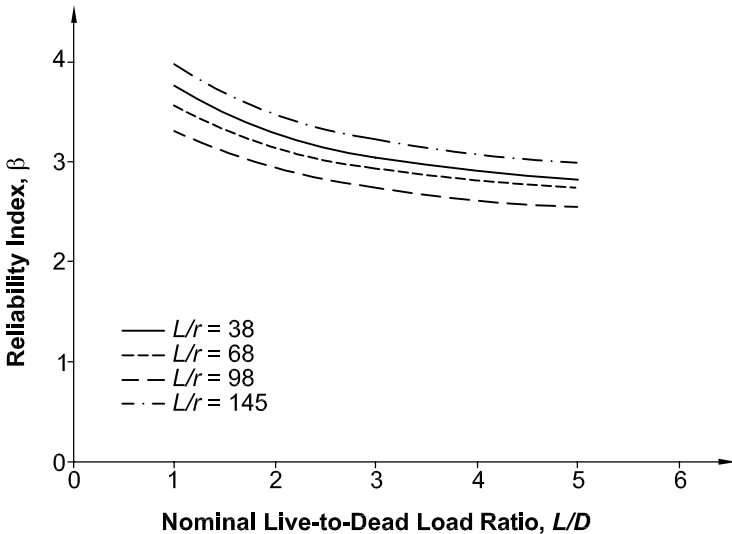

Fig. C-E1.2. Reliability of columns (ASD).

$\Omega = 1.67$, respectively, for $F_y = 50$ ksi (345 MPa). The reliability index does not fall below $\beta = 2.6$. This is comparable to the reliability of beams.

E2. EFFECTIVE LENGTH

The concept of a maximum limiting slenderness ratio has experienced an evolutionary change from a mandatory "...The slenderness ratio, KL/r , of compression members shall not exceed 200..." in the 1978 Specification to no restriction at all in the 2005 Specification (AISC, 2005a). The 1978 ASD and the 1999 LRFD Specifications (AISC, 1978; AISC, 2000b) provided a transition from the mandatory limit to a limit that was defined in the 2005 Specification by a User Note, with the observation that "...the slenderness ratio, KL/r , preferably should not exceed 200..." However, the designer should keep in mind that columns with a slenderness ratio of more than 200 will have an elastic buckling stress (Equation E3-4) less than 6.3 ksi (43.5 MPa). The traditional upper limit of 200 was based on professional judgment and practical construction economics, ease of handling, and care required to minimize inadvertent damage during fabrication, transport and erection. These criteria are still valid and it is not recommended to exceed this limit for compression members except for cases where special care is exercised by the fabricator and erector.

E3. FLEXURAL BUCKLING OF MEMBERS WITHOUT SLENDER ELEMENTS

Section E3 applies to compression members with all nonslender elements, as defined in Section B4.

The column strength equations in Section E3 are the same as those in the previous editions of the LRFD Specification, with the exception of the cosmetic replacement in

2005 of the slenderness term, $\lambda_c = \frac{KL}{\pi r} \sqrt{\frac{F_y}{E}}$, by the more familiar slenderness ratio, $\frac{KL}{r}$. For the convenience of those calculating the elastic buckling stress directly, without first calculating K , the limits on the use of Equations E3-2 and E3-3 are also provided in terms of the ratio F_y/F_e , as shown in the following discussion.

Comparisons between the previous column design curves and those introduced in the 2005 Specification and continued in this Specification are shown in Figures C-E3.1 and C-E3.2 for the case of $F_y = 50$ ksi (345 MPa). The curves show the variation of the available column strength with the slenderness ratio for LRFD and ASD, respectively. The LRFD curves reflect the change of the resistance factor, ϕ , from 0.85 to 0.90, as was explained in Commentary Section E1. These column equations provide improved economy in comparison with the previous editions of the Specification.

The limit between elastic and inelastic buckling is defined to be $\frac{KL}{r} = 4.71 \sqrt{\frac{E}{F_y}}$ or $\frac{F_y}{F_e} = 2.25$. These are the same as $F_e = 0.44F_y$ that was used in the 2005 Specification.

For convenience, these limits are defined in Table C-E3.1 for the common values of F_y .

One of the key parameters in the column strength equations is the elastic critical stress, F_e . Equation E3-4 presents the familiar Euler form for F_e . However, F_e can also be determined by other means, including a direct frame buckling analysis or a torsional or flexural-torsional buckling analysis as addressed in Section E4.

The column strength equations of Section E3 can also be used for frame buckling and for torsional or flexural-torsional buckling (Section E4); they can also be entered

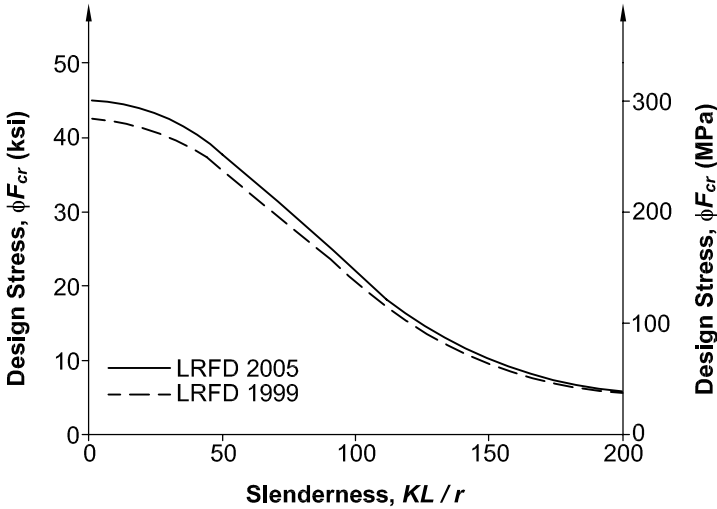

Fig. C-E3.1. LRFD column curves compared.

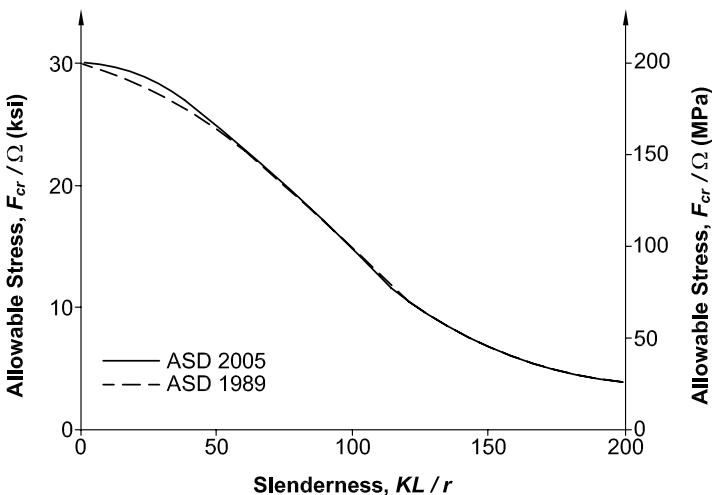

Fig. C-E3.2. ASD column curves compared.

TABLE C-E3.1
Limiting values of KL/r and F_e

F_y ksi (MPa)	Limiting $\frac{KL}{r}$	F_e ksi (MPa)
36 (250)	134	16.0 (111)
50 (345)	113	22.2 (153)
60 (415)	104	26.7 (184)
70 (485)	96	31.1 (215)

with a modified slenderness ratio for single-angle members (Section E5); and they can be modified by the Q -factor for columns with slender elements (Section E7).

E4. TORSIONAL AND FLEXURAL-TORSIONAL BUCKLING OF MEMBERS WITHOUT SLENDER ELEMENTS

Section E4 applies to singly symmetric and unsymmetric members, and certain doubly symmetric members, such as cruciform or built-up columns, with all nonslender elements, as defined in Section B4 for uniformly compressed elements. It also applies to doubly symmetric members when the torsional buckling length is greater than the flexural buckling length of the member.

The equations in Section E4 for determining the torsional and flexural-torsional elastic buckling loads of columns are derived in textbooks and monographs on structural stability [for example, Bleich (1952); Timoshenko and Gere (1961); Galambos (1968a); Chen and Atsuta (1977); Galambos and Surovek (2008), Ziemian (2010)]. Since these equations apply only to elastic buckling, they must be modified for inelastic buckling by using the torsional and flexural-torsional critical stress, F_{cr} , in the column equations of Section E3.

Torsional buckling of symmetric shapes and flexural-torsional buckling of unsymmetrical shapes are failure modes usually not considered in the design of hot-rolled columns. They generally do not govern, or the *critical load* differs very little from the weak-axis flexural buckling load. Torsional and flexural-torsional buckling modes may, however, control the strength of symmetric columns manufactured from relatively thin plate elements and unsymmetric columns and symmetric columns having torsional unbraced lengths significantly larger than the weak-axis flexural unbraced lengths. Equations for determining the elastic critical stress for such columns are given in Section E4. Table C-E4.1 serves as a guide for selecting the appropriate equations.

The simpler method of calculating the buckling strength of double-angle and tee-shaped members (Equation E4-2) uses directly the y -axis flexural strength from the column equations of Section E3 (Galambos, 1991).

TABLE C-E4.1
Selection of Equations for Torsional and Flexural-Torsional Buckling

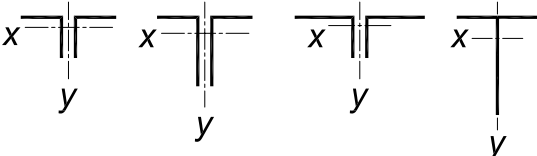
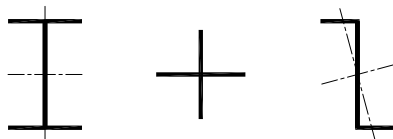
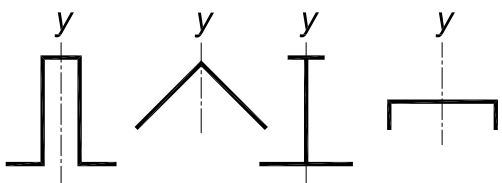
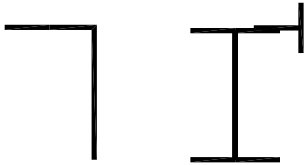
Type of Cross Section	Applicable Equations in Section E4
<p style="text-align: center;">Double angle and tee-shaped members Case (a) in Section E4</p> 	E4-2
<p style="text-align: center;">All doubly symmetric shapes and Z-shapes Case (b) (i) in Section E4</p> 	E4-4
<p style="text-align: center;">Singly symmetric members except double angles and tee-shaped members Case (b)(ii) in Section E4</p> 	E4-5
<p style="text-align: center;">Unsymymmetric shapes Case (b)(iii) in Section E4</p> 	E4-6

Equations E4-4 and E4-9 contain a torsional buckling effective length factor, K_z . This factor may be conservatively taken as $K_z = 1.0$. For greater accuracy, $K_z = 0.5$ if both ends of the column have a connection that restrains warping, say by boxing the end over a length at least equal to the depth of the member. If one end of the member is restrained from warping and the other end is free to warp, then $K_z = 0.7$.

At points of bracing both lateral and/or torsional bracing shall be provided, as required in Appendix 6. AISC Design Guide 9 (Seaburg and Carter, 1997) provides an overview of the fundamentals of torsional loading for structural steel members. Design examples are also included.

E5. SINGLE ANGLE COMPRESSION MEMBERS

The axial load capacity of single angles is to be determined in accordance with Section E3 or E7. However, as noted in Section E4 and E7, single angles with $b/t \leq 20$ do not require the computation of F_e using Equations E4-5 or E4-6. This applies to all currently produced hot rolled angles; use Section E4 to compute F_e for fabricated angles with $b/t > 20$.

Section E5 also provides a simplified procedure for the design of single angles subjected to an axial compressive load introduced through one connected leg. The angle is treated as an axially loaded member by adjusting the member slenderness. The attached leg is to be fixed to a gusset plate or the projecting leg of another member by welding or by a bolted connection with at least two bolts. The equivalent slenderness expressions in this section presume significant restraint about the y -axis, which is perpendicular to the connected leg. This leads to the angle member tending to bend and buckle primarily about the x -axis. For this reason, L/r_x is the slenderness parameter used. The modified slenderness ratios indirectly account for bending in the angles due to the eccentricity of loading and for the effects of end restraint from the truss chords.

The equivalent slenderness expressions also presume a degree of rotational restraint. Equations E5-3 and E5-4 [Case (b)] assume a higher degree of x -axis rotational restraint than do Equations E5-1 and E5-2 [Case (a)]. Equations E5-3 and E5-4 are essentially equivalent to those employed for equal-leg angles as web members in latticed transmission towers in ASCE 10-97 (ASCE, 2000).

In space trusses, the web members framing in from one face typically restrain the twist of the chord at the panel points and thus provide significant x -axis restraint of the angles under consideration. It is possible that the chords of a planar truss well restrained against twist justify use of Case (b), in other words, Equations E5-3 and E5-4. Similarly, simple single-angle diagonal braces in braced frames could be considered to have enough end restraint such that Case (a), in other words, Equations E5-1 and E5-2, could be employed for their design. This procedure, however, is not intended for the evaluation of the compressive strength of x -braced single angles.

The procedure in Section E5 permits use of unequal-leg angles attached by the smaller leg provided that the equivalent slenderness is increased by an amount that

is a function of the ratio of the longer to the shorter leg lengths, and has an upper limit on L/r_z .

If the single-angle compression members cannot be evaluated using the procedures in this section, use the provisions of Section H2. In evaluating P_n , the effective length due to end restraint should be considered. With values of effective length factors about the geometric axes, one can use the procedure in Lutz (1992) to compute an effective radius of gyration for the column. To obtain results that are not too conservative, one must also consider that end restraint reduces the eccentricity of the axial load of single-angle struts and thus the value of f_{rbw} or f_{rbz} used in the flexural term(s) in Equation H2-1.

E6. BUILT-UP MEMBERS

Section E6 addresses the strength and dimensional requirements of built-up members composed of two or more shapes interconnected by stitch bolts or welds.

1. Compressive Strength

This section applies to built-up members such as double-angle or double-channel members with closely spaced individual components. The longitudinal spacing of connectors connecting components of built-up compression members must be such that the slenderness ratio, L/r , of individual shapes does not exceed three-fourths of the slenderness ratio of the entire member. However, this requirement does not necessarily ensure that the effective slenderness ratio of the built-up member is equal to that of a built-up member acting as a single unit.

For a built-up member to be effective as a structural member, the end connection must be welded or pretensioned bolted with Class A or B faying surfaces. Even so, the compressive strength will be affected by the shearing deformation of the intermediate connectors. The Specification uses the effective slenderness ratio to consider this effect. Based mainly on the test data of Zandonini (1985), Zahn and Haaijer (1987) developed an empirical formulation of the effective slenderness ratio for the 1986 AISC *Load and Resistance Factor Design Specification for Structural Steel Buildings* (AISC, 1986). When pretensioned bolted or welded intermediate connectors are used, Aslani and Goel (1991) developed a semi-analytical formula for use in the 1993, 1999 and 2005 AISC Specifications (AISC, 1993, 2000b, 2005a). As more test data became available, a statistical evaluation (Sato and Uang, 2007) showed that the simplified expressions used in this Specification achieve the same level of accuracy.

Fastener spacing less than the maximum required for strength may be needed to ensure a close fit over the entire faying surface of components in continuous contact. Special requirements for weathering steel members exposed to atmospheric corrosion are given in Brockenbrough (1983).

2. Dimensional Requirements

Section E6.2 provides additional requirements on connector spacing and end connection for built-up member design. Design requirements for laced built-up members

where the individual components are widely spaced are also provided. Some dimensioning requirements are based upon judgment and experience. The provisions governing the proportioning of perforated cover plates are based upon extensive experimental research (Stang and Jaffe, 1948).

E7. MEMBERS WITH SLENDER ELEMENTS

The structural engineer designing with hot-rolled shapes will seldom find an occasion to turn to Section E7 of the Specification. Among rolled shapes, the most frequently encountered cases requiring the application of this section are beam shapes used as columns, columns containing angles with thin legs, and tee-shaped columns having slender stems. Special attention to the determination of Q must be given when columns are made by welding or bolting thin plates together.

The provisions of Section E7 address the modifications to be made when one or more plate elements in the column cross section are slender. A plate element is considered to be slender if its width-to-thickness ratio exceeds the limiting value, λ_r , defined in Table B4.1a. As long as the plate element is not slender, it can support the full yield stress without local buckling. When the cross section contains slender elements, the slenderness reduction factor, Q , defines the ratio of the stress at local buckling to the yield stress, F_y . The yield stress, F_y , is replaced by the value QF_y in the column equations of Section E3. These modified equations are repeated as Equations E7-2 and E7-3. This approach to dealing with columns with slender elements has been used since the 1969 AISC *Specification for the Design, Fabrication, and Erection of Structural Steel for Buildings* (AISC, 1969), emulating the 1969 AISI *Specification for the Design of Cold-Formed Steel Structural Members* (AISI, 1969). Prior to 1969, the AISC practice was to remove the width of the plate that exceeded the λ_r limit and check the remaining cross section for conformance with the allowable stress, which proved inefficient and uneconomical. The equations in Section E7 are almost identical to the original 1969 equations.

This Specification makes a distinction between columns having unstiffened and stiffened elements. Two separate philosophies are used: Unstiffened elements are considered to have attained their limit state when they reach the theoretical local buckling stress. Stiffened elements, on the other hand, make use of the post-buckling strength inherent in a plate that is supported on both of its longitudinal edges, such as in HSS columns. The effective width concept is used to obtain the added post-buckling strength. This dual philosophy reflects the 1969 practice in the design of cold-formed columns. Subsequent editions of the AISI Specifications, in particular, the *North American Specification for the Design of Cold-Formed Steel Structural Members* (AISI, 2001, 2007), hereafter referred to as the *AISI North American Specification*, adopted the effective width concept for both stiffened and unstiffened elements. Subsequent editions of the AISC Specification (including this Specification) did not follow the example set by AISI for unstiffened plates because the advantages of the post-buckling strength do not become available unless the plate elements are very slender. Such dimensions are common for cold-formed columns, but are rarely encountered in structures made from hot-rolled plates.

1. Slender Unstiffened Elements, Q_s

Equations for the slender element reduction factor, Q_s , are given in Section E7.1 for outstanding elements in rolled shapes (Case a), built-up shapes (Case b), single angles (Case c), and stems of tees (Case d). The underlying scheme for these provisions is illustrated in Figure C-E7.1. The curves show the relationship between the

Q -factor and a nondimensional slenderness ratio $\frac{b}{t} \sqrt{\frac{F_y}{E} \frac{12(1-\nu^2)}{\pi^2 k}}$. The width, b ,

and thickness, t , are defined for the applicable cross sections in Section B4; $\nu = 0.3$ (Poisson's ratio), and k is the plate buckling coefficient characteristic of the type of plate edge-restraint. For single angles, $k = 0.425$ (no restraint is assumed from the other leg), and for outstanding flange elements and stems of tees, k equals approximately 0.7, reflecting an estimated restraint from the part of the cross section to which the plate is attached on one of its edges, the other edge being free.

The curve relating Q to the plate slenderness ratio has three components: (i) a part where $Q = 1$ when the slenderness factor is less than or equal to 0.7 (the plate can be stressed up to its yield stress), (ii) the elastic plate buckling portion when buckling

is governed by $F_{cr} = \frac{\pi^2 Ek}{12(1-\nu^2) \left(\frac{b}{t}\right)^2}$, and (iii) a transition range that empirically

accounts for the effect of early yielding due to *residual stresses* in the shape. Generally this transition range is taken as a straight line. The development of the provisions for unstiffened elements is due to the research of Winter and his co-work-

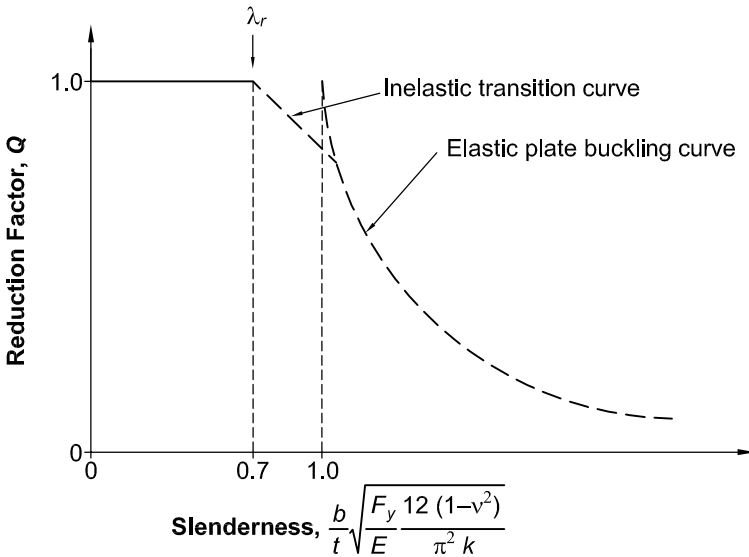

Fig. C-E7.1. Definition of Q_s for unstiffened slender elements.

ers, and a full listing of references is provided in the Commentary to the AISI *North American Specification* (AISI, 2001, 2007). The slenderness provisions are illustrated for the example of slender flanges of rolled shapes in Figure C-E7.2.

The equations for the unstiffened projecting flanges, angles and plates in built-up cross sections (Equations E7-7 through E7-9) have a history that starts with the research reported in Johnson (1985). It was noted in tests of beams with slender flanges and slender webs that there was an interaction between the buckling of the flanges and the distortions in the web causing an unconservative prediction of strength. A modification based on the equations recommended in Johnson (1985) appeared first in the 1989 *Specification for Structural Steel Buildings—Allowable Stress Design and Plastic Design* (AISC, 1989).

Modifications to simplify the original equations were introduced in the 1993 *Load and Resistance Factor Design Specification for Structural Steel Buildings* (AISC, 1993), and these equations have remained unchanged in the present Specification. The influence of web slenderness is accounted for by the introduction of the factor

$$k_c = \frac{4}{\sqrt{\frac{h}{t_w}}} \quad (\text{C-E7-1})$$

into the equations for λ_r and Q , where k_c is not taken as less than 0.35 nor greater than 0.76 for calculation purposes.

2. Slender Stiffened Elements, Q_a

While for slender unstiffened elements the Specification for local buckling is based on the limit state of the onset of plate buckling, an improved approach based on the

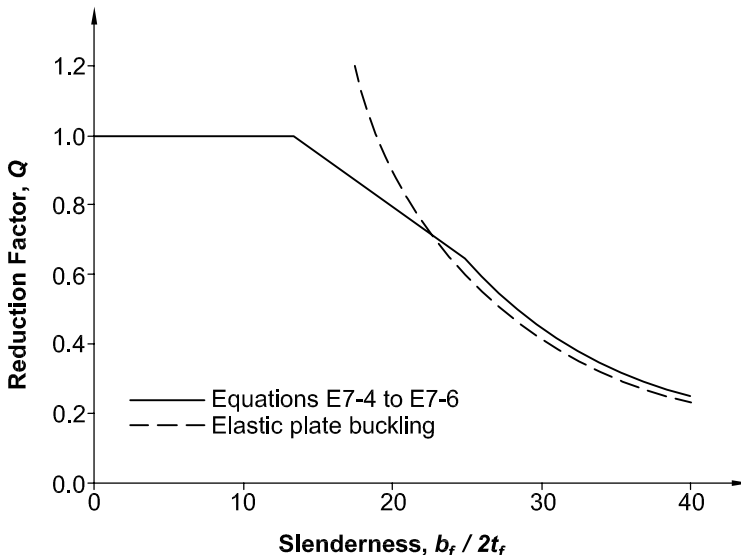

Fig. C-E7.2. Q for rolled wide-flange columns with $F_y = 50$ ksi (345 MPa).

effective width concept is used for the compressive strength of stiffened elements in columns. This method was first proposed in von Kármán et al. (1932). It was later modified by Winter (1947) to provide a transition between very slender elements and stockier elements shown by tests to be fully effective. As modified for the *AISI North American Specification* (AISI, 2001, 2007), the ratio of effective width to actual width increases as the level of compressive stress applied to a stiffened element in a member is decreased, and takes the form

$$\frac{b_e}{t} = 1.9 \sqrt{\frac{E}{f}} \left[1 - \frac{C}{(b/t)} \sqrt{\frac{E}{f}} \right] \quad (\text{C-E7-2})$$

where f is taken as F_{cr} of the column based on $Q = 1.0$, and C is a constant based on test results (Winter, 1947).

The basis for cold-formed steel columns in the *AISI North American Specification* editions since the 1970s is $C = 0.415$. The original AISI coefficient 1.9 in Equation C-E7-2 is changed to 1.92 in the Specification to reflect the fact that the modulus of elasticity E is taken as 29,500 ksi (203 400 MPa) for cold-formed steel, and 29,000 ksi (200 000 MPa) for hot-rolled steel.

For the case of square and rectangular box-sections of uniform thickness, where the sides provide negligible rotational restraint to one another, the value of $C = 0.38$ in Equation E7-18 is higher than the value of $C = 0.34$ in Equation E7-17. Equation E7-17 applies to the general case of stiffened plates in uniform compression where there is substantial restraint from the adjacent flange or web elements. The coefficients $C = 0.38$ and $C = 0.34$ are smaller than the corresponding value of $C = 0.415$ in the *AISI North American Specification* (AISI, 2001, 2007), reflecting the fact that hot-rolled steel sections have stiffer connections between plates due to welding or fillets in rolled shapes than do cold-formed shapes.

The classical theory of longitudinally compressed cylinders overestimates the actual buckling strength, often by 200% or more. Inevitable imperfections of shape and the eccentricity of the load are responsible for the reduction in actual strength below the theoretical strength. The limits in Section E7.2(c) are based upon test evidence (Sherman, 1976), rather than theoretical calculations, that local buckling will not occur if $\frac{D}{t} \leq \frac{0.11E}{F_y}$. When D/t exceeds this value but is less than $\frac{0.45E}{F_y}$, Equation E7-19 provides a reduction in the local buckling reduction factor Q . This Specification does not recommend the use of round HSS or pipe columns with $\frac{D}{t} > \frac{0.45E}{F_y}$.

CHAPTER F

DESIGN OF MEMBERS FOR FLEXURE

F1. GENERAL PROVISIONS

Chapter F applies to members subject to simple bending about one principal axis of the cross section. Section F2 gives the provisions for the flexural strength of doubly symmetric compact I-shaped and channel members subject to bending about their major axis. For most designers, the provisions in this section will be sufficient to perform their everyday designs. The remaining sections of Chapter F address less frequently occurring cases encountered by structural engineers. Since there are many such cases, many equations and many pages in the Specification, the table in User Note F1.1 is provided as a map for navigating through the cases considered in Chapter F. The coverage of the chapter is extensive and there are many equations that appear formidable; however, it is stressed again that for most designs, the engineer need seldom go beyond Section F2.

For all sections covered in Chapter F, the highest possible nominal flexural strength is the plastic moment, $M_n = M_p$. Being able to use this value in design represents the optimum use of the steel. In order to attain M_p the beam cross section must be compact and the member must be laterally braced. Compactness depends on the flange and web width-to-thickness ratios, as defined in Section B4. When these conditions are not met, the nominal flexural strength diminishes. All sections in Chapter F treat this reduction in the same way. For laterally braced beams, the plastic moment region extends over the range of width-to-thickness ratios, λ , terminating at λ_p . This is the compact condition. Beyond these limits the nominal flexural strength reduces linearly until λ reaches λ_r . This is the range where the section is noncompact. Beyond λ_r the section is a slender-element section.

These three ranges are illustrated in Figure C-F1.1 for the case of rolled wide-flange members for the limit state of flange local buckling. AISC Design Guide 25, *Frame Design Using Web-Tapered Members* (Kaehler et al., 2010), addresses flexural strength for web-tapered members. The curve in Figure C-F1.1 shows the relationship between the flange width-to-thickness ratio, $b_f/2t_f$, and the nominal flexural strength, M_n .

The basic relationship between the nominal flexural strength, M_n , and the unbraced length, L_b , for the limit state of lateral-torsional buckling is shown in Figure C-F1.2 for a compact section that is simply supported and subjected to uniform bending with $C_b = 1.0$.

There are four principal zones defined on the basic curve by the lengths L_{pd} , L_p and L_r . Equation F2-5 defines the maximum unbraced length, L_p , to reach M_p with uniform moment. Elastic lateral-torsional buckling will occur when the unbraced length is greater than L_r given by Equation F2-6. Equation F2-2 defines the range

of inelastic lateral-torsional buckling as a straight line between the defined limits M_p at L_p and $0.7F_y S_x$ at L_r . Buckling strength in the elastic region is given by Equation F2-3. The length L_{pd} is defined in Appendix 1 as the limiting unbraced length needed for plastic design. Although plastic design methods generally require more stringent limits on the unbraced length compared to elastic design, the magnitude of L_{pd} is often larger than L_p . The reason for this is because the L_{pd} expression

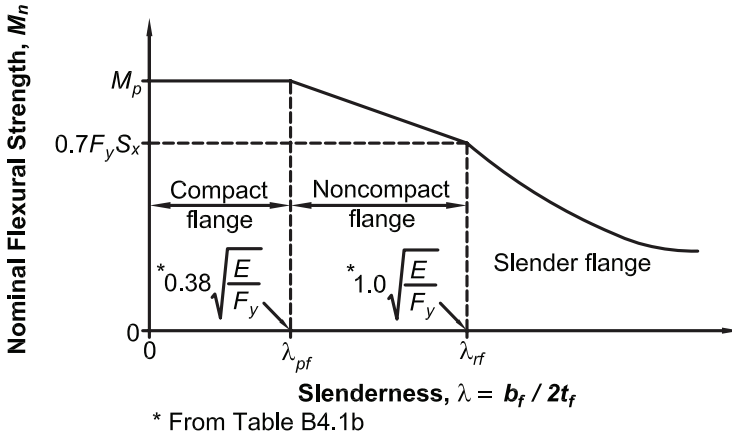

Fig. C-F1.1. Nominal flexural strength as a function of the flange width-to-thickness ratio of rolled I-shapes.

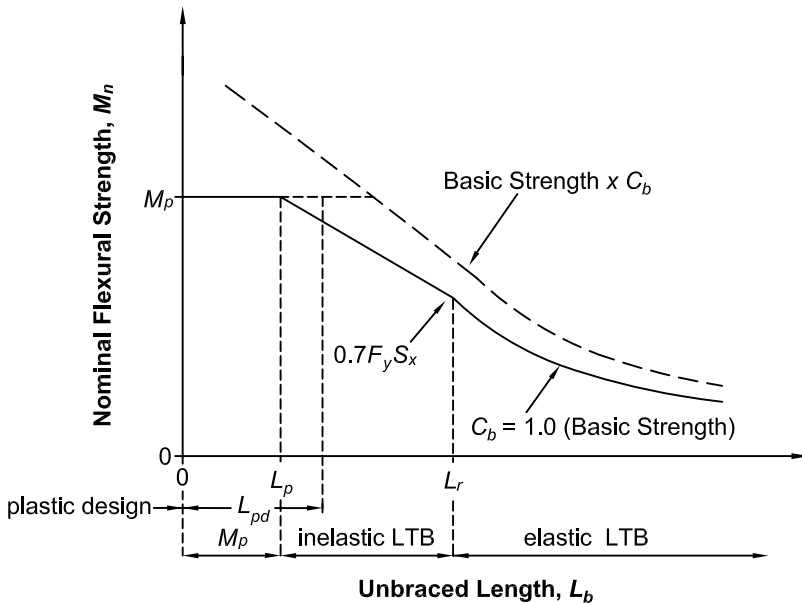

Fig. C-F1.2. Nominal flexural strength as a function of unbraced length and moment gradient.

accounts for moment gradient directly, while designs based upon an elastic analysis rely on C_b factors to account for the benefits of moment gradient as outlined in the following paragraphs.

For moment along the member other than uniform moment, the lateral buckling strength is obtained by multiplying the basic strength in the elastic and inelastic region by C_b as shown in Figure C-F1.2. However, in no case can the maximum moment capacity exceed the plastic moment, M_p . Note that L_p given by Equation F2-5 is merely a definition that has physical meaning only when $C_b = 1.0$. For C_b greater than 1.0, members with larger unbraced lengths can reach M_p , as shown by the curve for $C_b > 1.0$ in Figure C-F1.2. This length is calculated by setting Equation F2-2 equal to M_p and solving for L_b using the actual value of C_b .

Since 1961, the following equation has been used in AISC Specifications to adjust the lateral-torsional buckling equations for variations in the moment diagram within the unbraced length.

$$C_b = 1.75 + 1.05 \left(\frac{M_1}{M_2} \right) + 0.3 \left(\frac{M_1}{M_2} \right)^2 \quad (\text{C-F1-1})$$

where

M_1 = smaller moment at end of unbraced length, kip-in. (N-mm)

M_2 = larger moment at end of unbraced length, kip-in. (N-mm)

(M_1/M_2) is positive when moments cause reverse curvature and negative for single curvature

This equation is only applicable to moment diagrams that consist of straight lines between braced points—a condition that is rare in beam design. The equation provides a lower bound to the solutions developed in Salvadori (1956). Equation C-F1-1 can be easily misinterpreted and misapplied to moment diagrams that are not linear within the unbraced segment. Kirby and Nethercot (1979) present an equation that applies to various shapes of moment diagrams within the unbraced segment. Their original equation has been slightly adjusted to give Equation C-F1-2 (Equation F1-1 in the body of the Specification):

$$C_b = \frac{12.5M_{max}}{2.5M_{max} + 3M_A + 4M_B + 3M_C} \quad (\text{C-F1-2})$$

This equation gives a more accurate solution for a fixed-end beam, and gives approximately the same answers as Equation C-F1-1 for moment diagrams with straight lines between points of bracing. C_b computed by Equation C-F1-2 for moment diagrams with other shapes shows good comparison with the more precise but also more complex equations (Ziemian, 2010). The absolute values of the three quarter-point moments and the maximum moment regardless of its location are used in Equation C-F1-2. The maximum moment in the unbraced segment is always used for comparison with the nominal moment, M_n . The length between braces, not the distance to inflection points is used. It is still satisfactory to use C_b from Equation C-F1-1 for straight-line moment diagrams within the unbraced length.

The lateral-torsional buckling modification factor given by Equation C-F1-2 is applicable for doubly symmetric sections and should be modified for application with singly symmetric sections. Previous work considered the behavior of singly-symmetric I-shaped beams subjected to gravity loading (Helwig et al., 1997). The study resulted in the following expression:

$$C_b = \left[\frac{12.5M_{max}}{2.5M_{max} + 3M_A + 4M_B + 3M_C} \right] R_m \leq 3.0 \quad (\text{C-F1-3})$$

For single curvature bending: $R_m = 1.0$

For reverse curvature bending:

$$R_m = 0.5 + 2 \left(\frac{I_{y \text{ Top}}}{I_y} \right)^2 \quad (\text{C-F1-4})$$

where

$I_{y \text{ Top}}$ = moment of inertia of the top flange about an axis through the web, in.⁴
(mm⁴)

I_y = moment of inertia of the entire section about an axis through the web, in.⁴
(mm⁴)

Since Equation C-F1-3 was developed for gravity loading on beams with a horizontal orientation of the longitudinal axis, the top flange is defined as the flange above the geometric centroid of the section. The term in the brackets of Equation C-F1-3 is identical to Equation C-F1-2 while the factor R_m is a modifier for singly-symmetric sections that is greater than unity when the top flange is the larger flange and less than unity when the top flange is the smaller flange. For singly-symmetric sections subjected to reverse curvature bending, the lateral-torsional buckling strength should be evaluated by separately treating each flange as the compression flange and comparing the available flexural strength with the required moment that causes compression in the flange under consideration.

The C_b factors discussed above are defined as a function of the spacing between braced points. However, many situations arise where a beam may be subjected to reverse curvature bending and have one of the flanges continuously braced laterally by closely spaced joists and/or light gauge decking normally used for roofing or flooring systems. Although the lateral bracing provides significant restraint to one of the flanges, the other flange can still buckle laterally due to the compression caused by the reverse curvature bending. A variety of C_b expressions have been developed that are a function of the type of loading, distribution of the moment, and the support conditions. For gravity loaded beams with the top flange laterally restrained, the following expression is applicable (Yura, 1995; Yura and Helwig, 2009):

$$C_b = 3.0 - \frac{2}{3} \left(\frac{M_1}{M_o} \right) - \frac{8}{3} \left[\frac{M_{CL}}{(M_o + M_1)^*} \right] \quad (\text{C-F1-5})$$

where

- M_o = moment at the end of the unbraced length that gives the largest compressive stress in the bottom flange, kip-in. (N-mm)
- M_1 = moment at other end of the unbraced length, kip-in. (N-mm)
- M_{CL} = moment at the middle of the unbraced length, kip-in. (N-mm)
- $(M_o + M_1)^*$ = M_o if M_1 is positive

The unbraced length is defined as the spacing between locations where twist is restrained. The sign convention for the moments are shown in Figure C-F1.3. M_o and M_1 are negative as shown in the figure, while M_{CL} is positive. The asterisk on the last term in Equation C-F1-5 indicates that M_1 is taken as zero in the last term if it is positive. For example, considering the distribution of moment shown in Figure C-F1.4, the C_b value would be:

$$C_b = 3.0 - \frac{2}{3} \left(\frac{+200}{-100} \right) - \frac{8}{3} \left(\frac{+50}{-100} \right) = 5.67$$

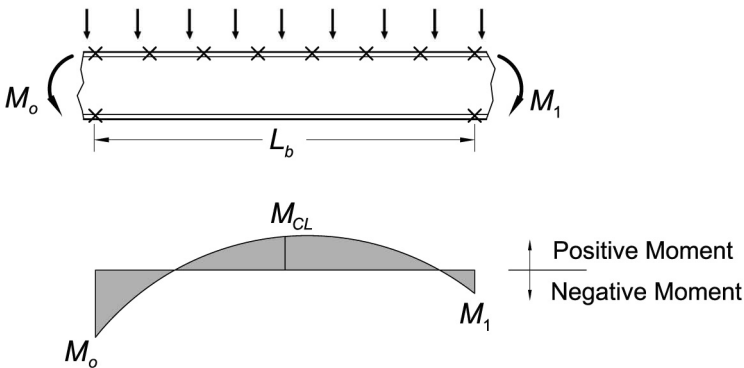

Fig. C-F1.3. Sign convention for moments in Equation C-F1-5.

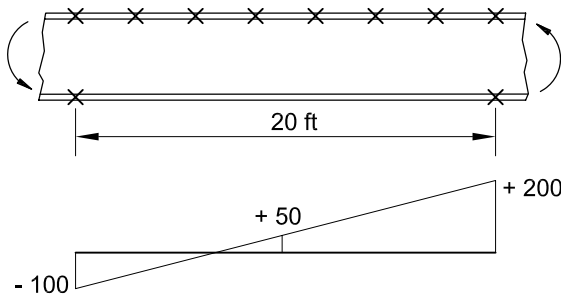

Fig. C-F1.4. Moment diagram for numerical example of application of Equation C-F1-5.

Note that $(M_o + M_1)^*$ is taken as M_o since M_1 is positive.

In this case, the $C_b = 5.67$ would be used with the lateral-torsional buckling strength for the beam using an unbraced length of 20 ft which is defined by locations where twist or lateral movement of both flanges is restrained.

A similar buckling problem occurs with roofing beams subjected to uplift from wind loading. The light gauge metal decking that is used for the roofing system usually provides continuous restraint to the top flange of the beam; however, the uplift can be large enough to cause the bottom flange to be in compression. The sign convention for the moment is the same as indicated in Figure C-F1.3. The moment must cause compression in the bottom flange (M_{CL} negative) for the beam to buckle. Three different expressions are given in Figure C-F1.5 depending on whether the end moments are positive or negative (*Yura and Helwig, 2009*). As outlined above, the unbraced length is defined as the spacing between points where both the top and bottom flange are restrained from lateral movement or between points restrained from twist.

The equations for the limit state of lateral-torsional buckling in Chapter F assume that the loads are applied along the beam centroidal axis. C_b may be conservatively

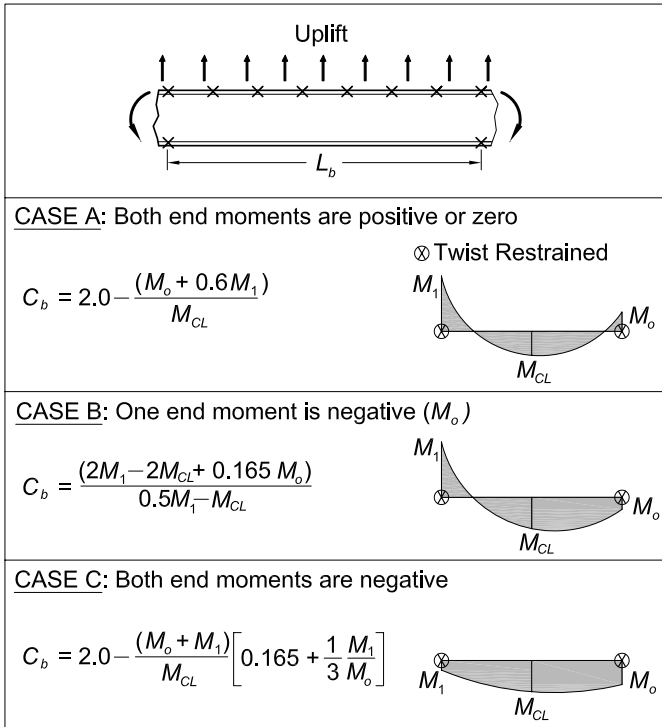

Fig. C-F1.5. C_b factors for uplift loading on beams with the top flange continuously restrained laterally.

taken equal to 1.0, with the exception of some cases involving unbraced overhangs or members with no bracing within the span and with significant loading applied to the top flange. If the load is placed on the top flange and the flange is not braced, there is a tipping effect that reduces the critical moment; conversely, if the load is suspended from an unbraced bottom flange, there is a stabilizing effect that increases the critical moment (Ziemian, 2010). For unbraced top flange loading on compact I-shaped members, the reduced critical moment may be conservatively approximated by setting the square root expression in Equation F2-4 equal to unity.

An effective length factor of unity is implied in the critical moment equations to represent the worst-case simply supported unbraced segment. Consideration of any end restraint due to adjacent unbuckled segments on the critical segment can increase its strength. The effects of beam continuity on lateral-torsional buckling have been studied, and a simple conservative design method, based on the analogy to end-restrained nonsway columns with an effective length less than unity, has been proposed (Ziemian, 2010).

F2. DOUBLY SYMMETRIC COMPACT I-SHAPED MEMBERS AND CHANNELS BENT ABOUT THEIR MAJOR AXIS

Section F2 applies to members with compact I-shaped or channel cross sections subject to bending about their major axis; hence, the only limit state to consider is lateral-torsional buckling. Almost all rolled wide-flange shapes listed in the AISC *Steel Construction Manual* (AISC, 2005b) are eligible to be designed by the provisions of this section, as indicated in the User Note in the Specification.

The equations in Section F2 are identical to the corresponding equations in Section F1 of the 1999 *Specification for Structural Steel Buildings—Load and Resistance Factor Design*, hereafter referred to as the 1999 LRFD Specification, (AISC, 2000b) and to the provisions in the 2005 *Specification for Structural Steel Buildings* (AISC, 2005a), hereafter referred to as the 2005 Specification, although they are presented in different form. Table C-F2.1 gives the list of equivalent equations.

The only difference between the 1999 LRFD Specification (AISC, 2000b) and this Specification is that the stress at the interface between inelastic and elastic buckling has been changed from $F_y - F_r$ in the 1999 edition to $0.7F_y$. In the specifications prior to the 2005 Specification the *residual stress*, F_r , for rolled and welded shapes was different, namely 10 ksi (69 MPa) and 16.5 ksi (114 MPa), respectively, while in the 2005 Specification and in this Specification the residual stress is taken as $0.3F_y$, so that the value of $F_y - F_r = 0.7F_y$ is adopted. This change was made in the interest of simplicity with negligible effect on economy.

The elastic lateral-torsional buckling stress, F_{cr} , of Equation F2-4:

$$F_{cr} = \frac{C_b \pi^2 E}{\left(\frac{L_b}{r_{ts}}\right)^2} \sqrt{1 + 0.078 \frac{J_c}{S_x h_o} \left(\frac{L_b}{r_{ts}}\right)^2} \quad (\text{C-F2-1})$$

TABLE C-F2.1
Comparison of Equations for
Nominal Flexural Strength

1999 AISC LRFD Specification Equations	2005 and 2010 Specification Equations
F1-1	F2-1
F1-2	F2-2
F1-13	F2-3

is identical to Equation F1-13 in the 1999 LRFD Specification:

$$F_{cr} = \frac{M_{cr}}{S_x} = \frac{C_b \pi}{L_b S_x} \sqrt{EI_y GJ + \left(\frac{\pi E}{L_b}\right)^2 I_y C_w} \quad (\text{C-F2-2})$$

if $c = 1$ (see Section F2 for definition):

$$r_{ts}^2 = \frac{\sqrt{I_y C_w}}{S_x}; \quad h_o = d - t_f; \quad \text{and} \quad \frac{2G}{\pi^2 E} = 0.0779$$

Equation F2-5 is the same as Equation F1-4 in the 1999 LRFD Specification, and Equation F2-6 corresponds to Equation F1-6. It is obtained by setting $F_{cr} = 0.7F_y$ in Equation F2-4 and solving for L_b . The format of Equation F2-6 has changed in the 2010 Specification so that it is not undefined at the limit when $J = 0$; otherwise it gives identical results. The term r_{ts} can conservatively be calculated as the radius of gyration of the compression flange plus one-sixth of the web.

These provisions have been simplified when compared to the previous ASD provisions based on a more informed understanding of beam limit states behavior. The maximum allowable stress obtained in these provisions may be slightly higher than the previous limit of $0.66F_y$, since the true plastic strength of the member is reflected by use of the plastic section modulus in Equation F2-1. The Section F2 provisions for unbraced length are satisfied through the use of two equations, one for inelastic lateral-torsional buckling (Equation F2-2), and one for elastic lateral-torsional buckling (Equation F2-3). Previous ASD provisions placed an arbitrary stress limit of $0.6F_y$ when a beam was not fully braced and required that three equations be checked with the selection of the largest stress to determine the strength of a laterally unbraced beam. With the current provisions, once the unbraced length is determined, the member strength can be obtained directly from these equations.

F3. DOUBLY SYMMETRIC I-SHAPED MEMBERS WITH COMPACT WEBS AND NONCOMPACT OR SLENDER FLANGES BENT ABOUT THEIR MAJOR AXIS

Section F3 is a supplement to Section F2 for the case where the flange of the section is noncompact or slender (see Figure C-F1.1, linear variation of M_n between λ_{pf} and λ_{rf}). As pointed out in the User Note of Section F2, very few rolled wide-flange shapes are subject to this criterion.

F4. OTHER I-SHAPED MEMBERS WITH COMPACT OR NONCOMPACT WEBS BENT ABOUT THEIR MAJOR AXIS

The provisions of Section F4 are applicable to doubly symmetric I-shaped beams with noncompact webs and to singly symmetric I-shaped members with compact or noncompact webs (see the Table in User Note F1.1). This section deals with welded I-shaped beams where the webs are not slender. Flanges may be compact, noncompact or slender. The following section, F5, considers welded I-shapes with slender webs. The contents of Section F4 are based on White (2004).

Four limit states are considered: (a) compression flange yielding; (b) lateral-torsional buckling (LTB); (c) flange local buckling (FLB); and (d) tension flange yielding (TFY). The effect of inelastic buckling of the web is taken care of indirectly by multiplying the moment causing yielding in the compression flange by a factor, R_{pc} , and the moment causing yielding in the tension flange by a factor, R_{pt} . These two factors can vary from unity to as high as 1.6. Conservatively, they can be assumed to equal 1.0. The following steps are provided as a guide to the determination of R_{pc} and R_{pt} .

Step 1. Calculate h_p and h_c , as defined in Figure C-F4.1.

Step 2. Determine web slenderness and yield moments in compression and tension:

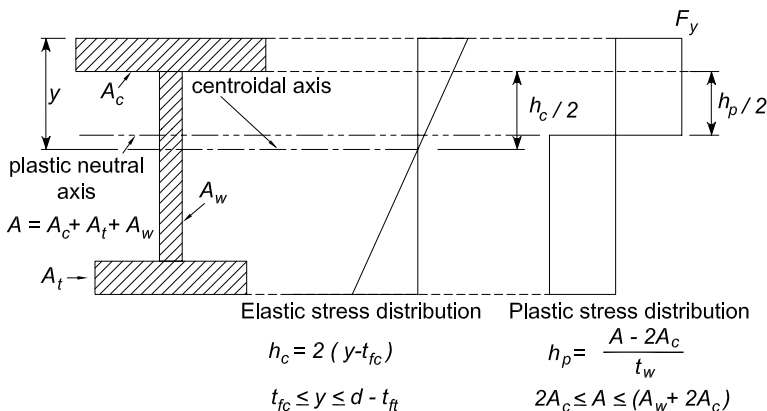

Fig. C-F4.1. Elastic and plastic stress distributions.

$$\left\{ \begin{array}{l} \lambda = \frac{h_c}{t_w} \\ S_{xc} = \frac{I_x}{y}; \quad S_{xt} = \frac{I_x}{d-y} \\ M_{yc} = F_y S_{xc}; \quad M_{yt} = F_y S_{xt} \end{array} \right\} \quad (\text{C-F4-1})$$

Step 3. Determine λ_{pw} and λ_{rw} :

$$\left\{ \begin{array}{l} \lambda_{pw} = \frac{\frac{h_c}{h_p} \sqrt{\frac{E}{F_y}}}{\left[\frac{0.54 M_p}{M_y} - 0.09 \right]^2} \leq 5.70 \sqrt{\frac{E}{F_y}} \\ \lambda_{rw} = 5.70 \sqrt{\frac{E}{F_y}} \end{array} \right\} \quad (\text{C-F4-2})$$

If $\lambda > \lambda_{rw}$, then the web is slender and the design is governed by Section F5.

Step 4. Calculate R_{pc} and R_{pt} using Section F4.

The basic maximum nominal moment is $R_{pc} M_{yc} = R_{pc} F_y S_{xc}$ if the flange is in compression, and $R_{pt} M_{yt} = R_{pt} F_y S_{xt}$ if it is in tension. Thereafter, the provisions are the same as for doubly symmetric members in Sections F2 and F3. For the limit state of lateral-torsional buckling, I-shaped members with cross sections that have unequal flanges are treated as if they were doubly symmetric I-shapes. That is, Equations F2-4 and F2-6 are the same as Equations F4-5 and F4-8, except the former use S_x and the latter use S_{xc} , the elastic section moduli of the entire section and of the compression side, respectively. This is a simplification that tends to be somewhat conservative if the compression flange is smaller than the tension flange, and it is somewhat unconservative when the reverse is true. It is also required to check for tension flange yielding if the tension flange is smaller than the compression flange (Section F4.4).

For a more accurate solution, especially when the loads are not applied at the centroid of the member, the designer is directed to Chapter 5 of the SSRC Guide and other references (Galambos, 2001; White and Jung, 2003; Ziemian, 2010). The following alternative equations in lieu of Equations F4-4, F4-5 and F4-8 are provided by White and Jung:

$$M_n = C_b \frac{\pi^2 E I_y}{L_b^2} \left\{ \frac{\beta_x}{2} + \sqrt{\left(\frac{\beta_x}{2} \right)^2 + \frac{C_w}{I_y} \left[1 + 0.0390 \frac{J}{C_w} L_b^2 \right]} \right\} \quad (\text{C-F4-3})$$

$$L_r = \frac{1.38 E \sqrt{I_y J}}{S_{xc} F_L} \sqrt{\frac{2.6 \beta_x F_L S_{xc}}{E J} + 1 + \sqrt{\left[\frac{2.6 \beta_x F_L S_{xc}}{E J} + 1 \right]^2 + \frac{27.0 C_w}{I_y} \left(\frac{F_L S_{xc}}{E J} \right)^2}} \quad (\text{C-F4-4})$$

where the coefficient of monosymmetry, $\beta_x = 0.9h\alpha\left(\frac{I_{yc}}{I_{yt}} - 1\right)$,

the warping constant, $C_w = h^2I_{yc}\alpha$, and $\alpha = \frac{1}{\frac{I_{yc}}{I_{yt}} + 1}$.

F5. DOUBLY SYMMETRIC AND SINGLY SYMMETRIC I-SHAPED MEMBERS WITH SLENDER WEBS BENT ABOUT THEIR MAJOR AXIS

This section applies to doubly and singly symmetric I-shaped welded plate girders with a slender web, that is, $\frac{h_c}{t_w} > \lambda_r = 5.70\sqrt{\frac{E}{F_y}}$. The applicable limit states are compression flange yielding, lateral-torsional buckling, compression flange local buckling, and tension flange yielding. The provisions in this section have changed little since 1963. The provisions for plate girders are based on research reported in Basler and Thürlimann (1963).

There is no seamless transition between the equations in Section F4 and F5. Thus the bending strength of a girder with $F_y = 50$ ksi (345 MPa) and a web slenderness $h/t_w = 137$ is not close to that of a girder with $h/t_w = 138$. These two slenderness ratios are on either side of the limiting ratio. This gap is caused by the discontinuity between the lateral-torsional buckling resistances predicted by Section F4 and those predicted by Section F5 due to the implicit use of $J = 0$ in Section F5. However, for typical noncompact web section members close to the noncompact web limit, the influence of J on the lateral-torsional buckling resistance is relatively small (for example, the calculated L_r values including J versus using $J = 0$ typically differ by less than 10%). The implicit use of $J = 0$ in Section F5 is intended to account for the influence of web distortional flexibility on the lateral-torsional buckling resistance for slender-web I-section members.

F6. I-SHAPED MEMBERS AND CHANNELS BENT ABOUT THEIR MINOR AXIS

I-shaped members and channels bent about their minor axis do not experience lateral-torsional buckling or web buckling. The only limit states to consider are yielding and flange local buckling. The user note informs the designer of the few rolled shapes that need to be checked for flange local buckling.

F7. SQUARE AND RECTANGULAR HSS AND BOX-SHAPED MEMBERS

The provisions for the nominal flexural strength of HSS include the limit states of yielding and local buckling. Square and rectangular HSS are typically not subject to lateral-torsional buckling.

Because of the high torsional resistance of the closed cross section, the critical unbraced lengths, L_p and L_r , that correspond to the development of the plastic moment and the yield moment, respectively, are very large. For example, as shown in Figure C-F7.1, an HSS20x4x5¹⁶ (HSS508x101.6x7.9), which has one of the largest depth-to-width ratios among standard HSS, has L_p of 6.7 ft (2.0 m) and L_r of 137 ft (42 m) as determined in accordance with the 1993 *Load and Resistance Factor Design Specification for Structural Steel Buildings* (AISC, 1993). An extreme deflection limit might correspond to a length-to-depth ratio of 24 or a length of 40 ft (12 m) for this member. Using the specified linear reduction between the plastic moment and the yield moment for lateral-torsional buckling, the plastic moment is reduced by only 7% for the 40-ft (12-m) length. In most practical designs where there is a moment gradient and the lateral-torsional buckling modification factor, C_b , is larger than unity, the reduction will be nonexistent or insignificant.

The provisions for local buckling of noncompact rectangular HSS are also the same as those in the previous sections of this chapter: $M_n = M_p$ for $b/t \leq \lambda_p$, and a linear transition from M_p to $F_y S_x$ when $\lambda_p < b/t \leq \lambda_r$. The equation for the effective width of the compression flange when b/t exceeds λ_r is the same as that used for rectangular HSS in axial compression except that the stress is taken as the yield stress. This implies that the stress in the corners of the compression flange is at yield when the ultimate post-buckling strength of the flange is reached. When using the effective width, the nominal flexural strength is determined from the effective section modulus to the compression flange using the distance from the shifted neutral axis. A slightly conservative estimate of the nominal flexural strength can be obtained by using the effective width for both the compression and tension flange, thereby maintaining the symmetry of the cross section and simplifying the calculations.

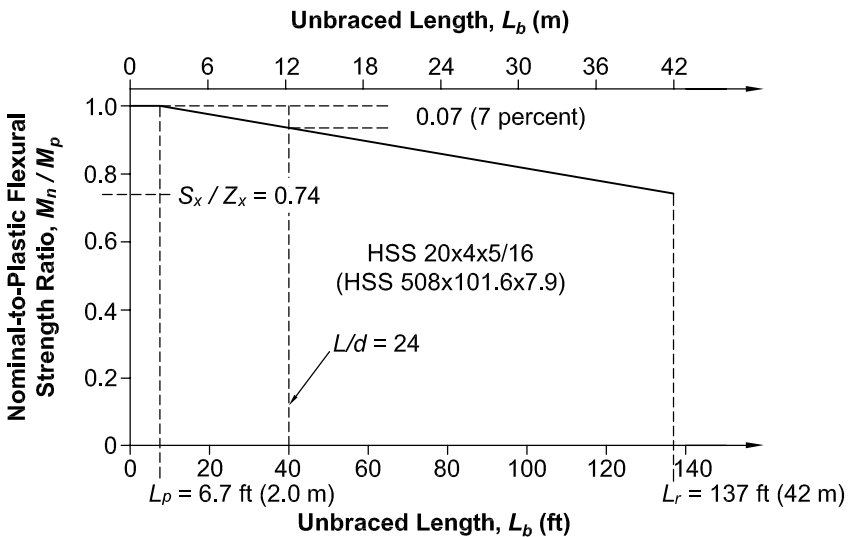

Fig. C-F7.1. Lateral-torsional buckling of rectangular HSS.

F8. ROUND HSS

Round HSS are not subject to lateral-torsional buckling. The failure modes and post-buckling behavior of round HSS can be grouped into three categories (Sherman, 1992; Ziemian, 2010):

- (a) For low values of D/t , a long *plastic plateau* occurs in the moment-rotation curve. The cross section gradually ovalizes, local wave buckles eventually form, and the moment resistance subsequently decays slowly. Flexural strength may exceed the theoretical plastic moment due to *strain hardening*.
- (b) For intermediate values of D/t , the plastic moment is nearly achieved but a single local buckle develops and the flexural strength decays slowly with little or no plastic plateau region.
- (c) For high values of D/t , multiple buckles form suddenly with very little ovalization and the flexural strength drops quickly.

The flexural strength provisions for round HSS reflect these three regions of behavior and are based upon five experimental programs involving hot-formed seamless pipe, electric-resistance-welded pipe, and fabricated tubing (Ziemian, 2010).

F9. TEES AND DOUBLE ANGLES LOADED IN THE PLANE OF SYMMETRY

The lateral-torsional buckling (LTB) strength of singly symmetric tee beams is given by a fairly complex formula (Ziemian, 2010). Equation F9-4 is a simplified formulation based on Kitipornchai and Trahair (1980). See also Ellifritt et al. (1992).

The C_b factor used for I-shaped beams is unconservative for tee beams with the stem in compression. For such cases, $C_b = 1.0$ is appropriate. When beams are bent in reverse curvature, the portion with the stem in compression may control the LTB resistance even though the moments may be small relative to other portions of the unbraced length with $C_b \approx 1.0$. This is because the LTB strength of a tee with the stem in compression may be only about one-fourth of the strength for the stem in tension. Since the buckling strength is sensitive to the moment diagram, C_b has been conservatively taken as 1.0. In cases where the stem is in tension, connection details should be designed to minimize any end restraining moments that might cause the stem to be in compression.

The 2005 Specification did not have provisions for the local buckling strength of the stems of tee sections and the legs of double angle sections under flexural compressive stress gradient. The Commentary to this Section in the 2005 Specification explained that the local buckling strength was accounted for in the equation for the lateral-torsional buckling limit state, Equation F9-4, when the unbraced length, L_b , approached zero. While this is a correct procedure, it led to confusion and to many questions by users of the Specification. For this reason, Section F9.4, "Local Buckling of Tee Stems in Flexural Compression," was added to provide an explicit set of formulas for the 2010 Specification.

The derivation of the formulas is provided here to explain the changes. The classical formula for the elastic buckling of a rectangular plate is (Ziemian, 2010):

$$F_{cr} = \frac{\pi^2 Ek}{12(1 - \nu^2) \left(\frac{b}{t}\right)^2} \tag{C-F9-1}$$

where

- $\nu = 0.3$ (Poisson's ratio)
- $b/t =$ plate width-to-thickness ratio
- $k =$ plate buckling coefficient

For the stem of tee sections, the width-to-thickness ratio is equal to d/t_w . The two rectangular plates in Figure C-F9.1 are fixed at the top, free at the bottom and loaded, respectively, with a uniform and a linearly varying compressive stress. The corresponding plate buckling coefficients, k , are 1.33 and 1.61 (Figure 4.4, Ziemian, 2010). The graph in Figure C-F9.2 shows the general scheme used historically in developing the local buckling criteria in AISC Specifications. The ordinate is the critical stress divided by the yield stress, and the abscissa is a nondimensional width-to-thickness ratio,

$$\bar{\lambda} = \frac{b}{t} \sqrt{\frac{F_y}{E}} \sqrt{\frac{12(1 - \nu^2)}{\pi^2 k}} \tag{C-F9-2}$$

In the traditional scheme it is assumed the critical stress is the yield stress, F_y , as long as $\bar{\lambda} \leq 0.7$. Elastic buckling, governed by Equation C-F9-1 commences when

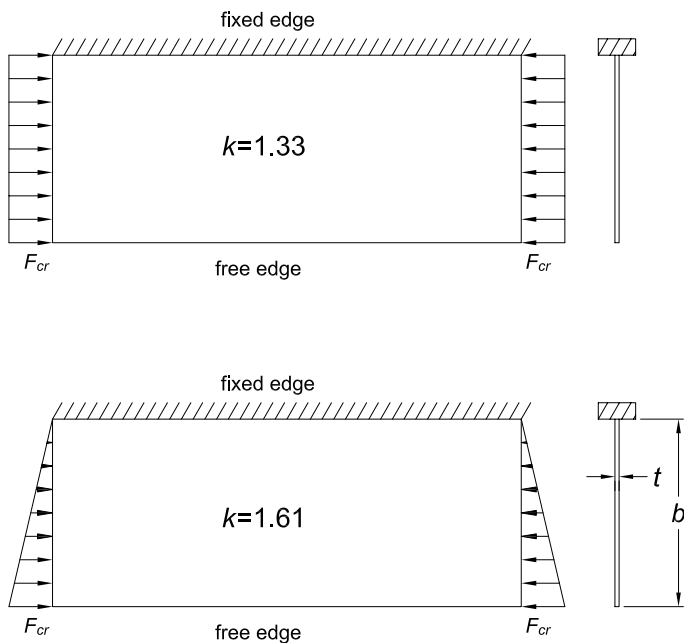

Fig.C-F9.1 Plate buckling coefficients for uniform compression and for linearly varying compressive stresses.

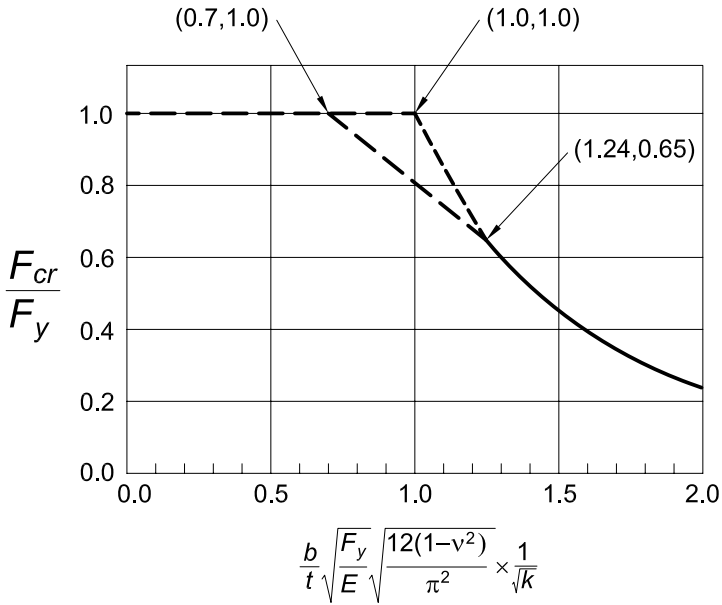

Fig. C-F9.2. General scheme for plate local buckling limit states.

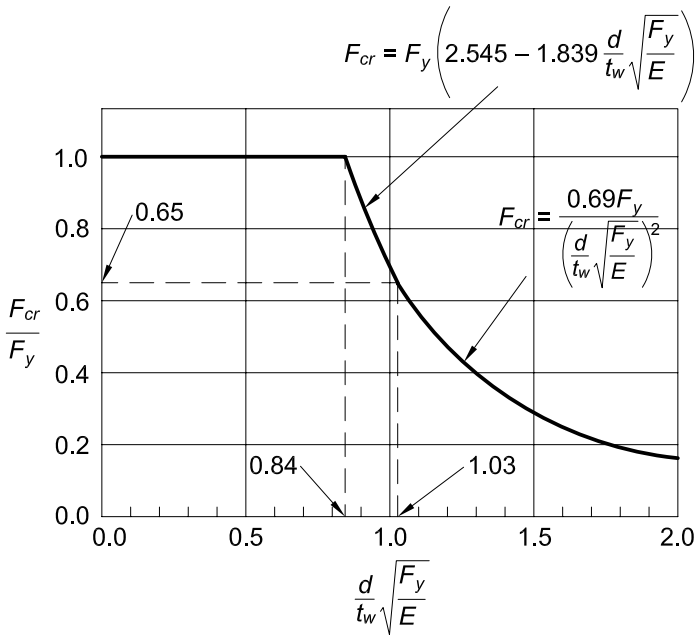

Fig. C-F9.3. Local buckling of tee stem in flexural compression.

$\bar{\lambda} = 1.24$ and $F_{cr} = 0.65F_y$. Between these two points the transition is assumed linear to account for initial deflections and residual stresses. While these assumptions are arbitrary empirical values, they have proven satisfactory. The curve in Figure C-F9.3 shows the graph of the formulas adopted for the stem of tee sections and the legs of double angle sections when these elements are subject to flexural compression. The limiting width-to-thickness ratio up to which $F_{cr} = F_y$ is (using $\nu = 0.3$ and $k = 1.61$):

$$\bar{\lambda} = 0.7 = \frac{b}{t} \sqrt{\frac{F_y}{E}} \sqrt{\frac{12(1-\nu^2)}{\pi^2 k}} \rightarrow \frac{b}{t} = \frac{d}{t_w} = 0.84 \sqrt{\frac{E}{F_y}}$$

The elastic buckling range was assumed to be governed by the same equation as the local buckling of the flanges of a wide-flange beam bent about its minor axis (Equation F6-4):

$$F_{cr} = \frac{0.69E}{\left(\frac{d}{t_w}\right)^2}$$

The underlying plate buckling coefficient for this equation is $k = 0.76$, which is a conservative assumption for tee stems in flexural compression. The straight-line transition between the end of the yield limit and the onset of the elastic buckling range is also indicated in Figure C-F9.3.

Flexure about the y -axis of tees and double angles does not occur frequently and is not covered in this Specification. However, guidance is given here to address this condition. The yield limit state and the local buckling limit state of the flange can be checked by using Equations F6-1 through F6-3. Lateral-torsional buckling can conservatively be calculated by assuming the flange acts alone as a rectangular beam, using Equations F11-2 through F11-4. Alternately, an elastic critical moment given as

$$M_e = \frac{\pi}{L_b} \sqrt{EI_x GJ} \quad (\text{C-F9-3})$$

may be used in Equations F10-2 or F10-3 to obtain the nominal flexural strength.

F10. SINGLE ANGLES

Flexural strength limits are established for the limit states of yielding, lateral-torsional buckling, and leg local buckling of single-angle beams. In addition to addressing the general case of unequal-leg single angles, the equal-leg angle is treated as a special case. Furthermore, bending of equal-leg angles about a geometric axis, an axis parallel to one of the legs, is addressed separately as it is a common case of angle bending.

The tips of an angle refer to the free edges of the two legs. In most cases of unrestrained bending, the flexural stresses at the two tips will have the same sign (tension or compression). For constrained bending about a geometric axis, the tip stresses will

differ in sign. Provisions for both tension and compression at the tip should be checked as appropriate, but in most cases it will be evident which controls.

Appropriate serviceability limits for single-angle beams need also to be considered. In particular, for longer members subjected to unrestrained bending, deflections are likely to control rather than lateral-torsional buckling or leg local buckling strength.

The provisions in this section follow the general format for nominal flexural resistance (see Figure C-F1.2). There is a region of full plastification, a linear transition to the yield moment, and a region of local buckling.

1. Yielding

The strength at full yielding is limited to a shape factor of 1.50 applied to the yield moment. This leads to a lower bound plastic moment for an angle that could be bent about any axis, inasmuch as these provisions are applicable to all flexural conditions. The 1.25 factor originally used was known to be a conservative value. Research work (Earls and Galambos, 1997) has indicated that the 1.50 factor represents a better lower bound value. Since the shape factor for angles is in excess of 1.50, the nominal design strength, $M_n = 1.5M_y$, for compact members is justified provided that instability does not control.

2. Lateral-Torsional Buckling

Lateral-torsional buckling may limit the flexural strength of an unbraced single-angle beam. As illustrated in Figure C-F10.1, Equation F10-2 represents the elastic buckling portion with the maximum nominal flexural strength, M_n , equal to 75% of the theoretical buckling moment, M_e . Equation F10-3 represents the inelastic buckling transition expression between $0.75M_y$ and $1.5M_y$. The maximum beam flexural strength $M_n = 1.5M_y$ will occur when the theoretical buckling moment, M_e , reaches or exceeds $7.7M_y$. M_y is the moment at first yield in Equations F10-2 and F10-3, the

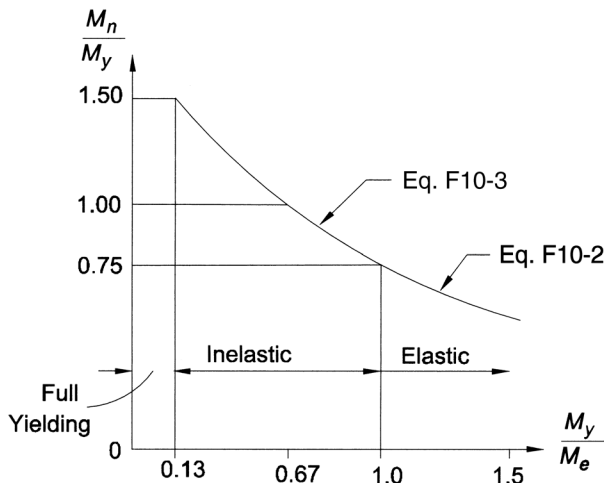

Fig. C-F10.1. Lateral-torsional buckling limits of a single-angle beam.

same as the M_y in Equation F10-1. These equations are modifications of those developed from the results of Australian research on single angles in flexure and on an analytical model consisting of two rectangular elements of length equal to the actual angle leg width minus one-half the thickness (AISC, 1975; Leigh and Lay, 1978, 1984; Madugula and Kennedy, 1985).

When bending is applied about one leg of a laterally unrestrained single angle, the angle will deflect laterally as well as in the bending direction. Its behavior can be evaluated by resolving the load and/or moments into principal axis components and determining the sum of these principal axis flexural effects. Subsection (a) of Section F10.2(iii) is provided to simplify and expedite the calculations for this common situation with equal-leg angles. For such unrestrained bending of an equal-leg angle, the resulting maximum normal stress at the angle tip (in the direction of bending) will be approximately 25% greater than the calculated stress using the geometric axis section modulus. The value of M_e given by Equations F10-6a and F10-6b and the evaluation of M_y using 0.80 of the geometric axis section modulus reflect bending about the inclined axis shown in Figure C-F10.2.

The deflection calculated using the geometric axis moment of inertia has to be increased 82% to approximate the total deflection. Deflection has two components: a vertical component (in the direction of applied load) of 1.56 times the calculated value and a horizontal component of 0.94 times the calculated value. The resultant total deflection is in the general direction of the weak principal axis bending of the angle (see Figure C-F10.2). These unrestrained bending deflections should be considered in evaluating serviceability and will often control the design over lateral-torsional buckling.

The horizontal component of deflection being approximately 60% of the vertical deflection means that the lateral restraining force required to achieve purely vertical

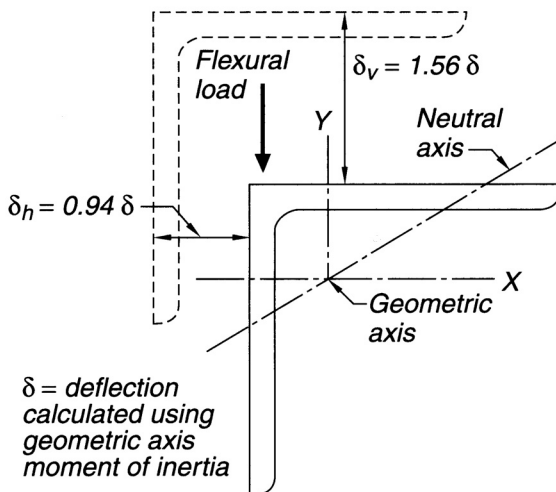

Fig. C-F10.2. Geometric axis bending of laterally unrestrained equal-leg angles.

deflection must be 60% of the applied load value (or produce a moment 60% of the applied value), which is very significant.

Lateral-torsional buckling is limited by M_e (Leigh and Lay, 1978, 1984) as defined in Equation F10-6a, which is based on

$$M_{cr} = \frac{2.33Eb^4t}{(1+3\cos^2\theta)(KL)^2} \left[\sqrt{\sin^2\theta + \frac{0.156(1+3\cos^2\theta)(KL)^2t^2}{b^4}} + \sin\theta \right] \quad (\text{C-F10-1})$$

(the general expression for the critical moment of an equal-leg angle) with $\theta = -45^\circ$ for the condition where the angle tip stress is compressive (see Figure C-F10.3). Lateral-torsional buckling can also limit the flexural strength of the cross section when the maximum angle tip stress is tensile from geometric axis flexure, especially with use of the flexural strength limits in Section F10.2. Using $\theta = 45^\circ$ in Equation C-F10-1, the resulting expression is Equation F10-6b with a +1 instead of -1 as the last term.

Stress at the tip of the angle leg parallel to the applied bending axis is of the same sign as the maximum stress at the tip of the other leg when the single angle is unrestrained. For an equal-leg angle this stress is about one-third of the maximum stress. It is only necessary to check the nominal bending strength based on the tip of the angle leg with the maximum stress when evaluating such an angle. If an angle is subjected to an axial compressive load, the flexural limits obtained from Section F10.2(iii) cannot be used due to the inability to calculate a proper moment magnification factor for use in the interaction equations.

For unequal-leg angles and for equal-leg angles in compression without lateral-torsional restraint, the applied load or moment must be resolved into components along the two principal axes in all cases and design must be for *biaxial bending* using the interaction equations in Chapter H.

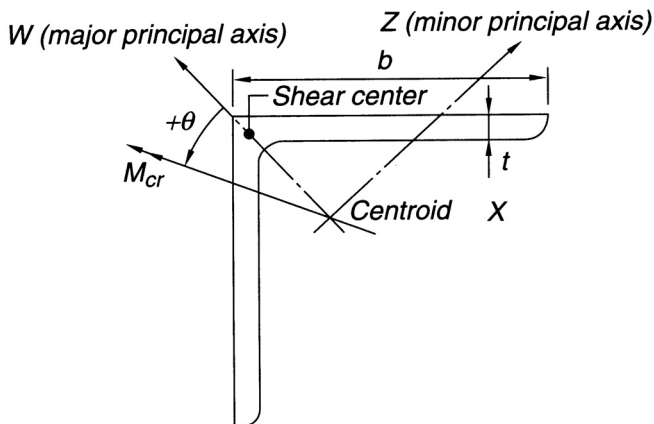

Fig. C-F10.3. Equal-leg angle with general moment loading.

Under major axis bending of equal-leg angles, Equation F10-4 in combination with Equations F10-2 and F10-3 controls the available moment against overall lateral-torsional buckling of the angle. This is based on M_{cr} given in Equation C-F10-1 with $\theta = 0^\circ$.

Lateral-torsional buckling for this case will reduce the stress below $1.5M_y$, only for $L/t \geq 3,675C_b/F_y$ ($M_e = 7.7M_y$). If the Lt/b^2 parameter is small (less than approximately $0.87C_b$ for this case), local buckling will control the available moment and M_n based on lateral-torsional buckling need not be evaluated. Local buckling must be checked using Section F10.3.

Lateral-torsional buckling about the major principal w -axis of an unequal-leg angle is controlled by M_e in Equation F10-5. The section property, β_w , reflects the location of the shear center relative to the principal axis of the section and the bending direction under uniform bending. Positive β_w and maximum M_e occur when the shear center is in flexural compression while negative β_w and minimum M_e occur when the shear center is in flexural tension (see Figure C-F10.4). This β_w effect is consistent with behavior of singly symmetric I-shaped beams, which are more stable when the compression flange is larger than the tension flange. For principal w -axis bending of equal-leg angles, β_w is equal to zero due to symmetry and Equation F10-5 reduces to Equation F10-4 for this special case.

For reverse curvature bending, part of the unbraced length has positive β_w , while the remainder has negative β_w ; conservatively, the negative value is assigned for that entire unbraced segment.

The factor β_w is essentially independent of angle thickness (less than 1% variation from mean value) and is primarily a function of the leg widths. The average values shown in Table C-F10.1 may be used for design.

3. Leg Local Buckling

The b/t limits have been modified to be more representative of flexural limits rather than using those for single angles under uniform compression. Typically the flexural

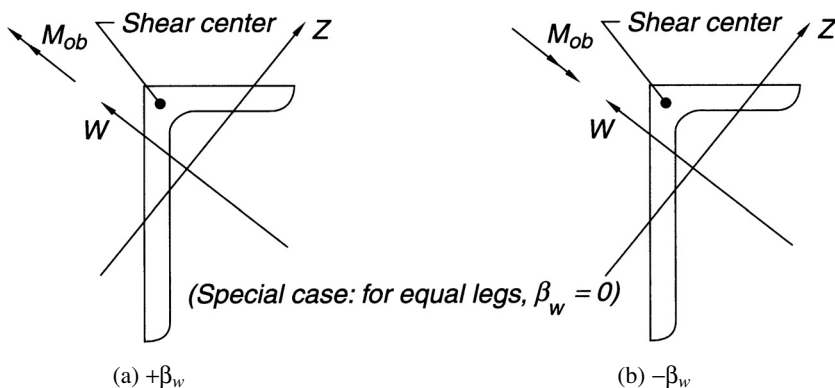

Fig. C-F10.4. Unequal-leg angle in bending.

TABLE C-F10.1
 β_w Values for Angles

Angle size in. (mm)	β_w in. (mm)*
8 × 6 (203 × 152)	3.31 (84.1)
8 × 4 (203 × 102)	5.48 (139)
7 × 4 (178 × 102)	4.37 (111)
6 × 4 (152 × 102)	3.14 (79.8)
6 × 3½ (152 × 89)	3.69 (93.7)
5 × 3½ (127 × 89)	2.40 (61.0)
5 × 3 (127 × 76)	2.99 (75.9)
4 × 3½ (102 × 89)	0.87 (22.1)
4 × 3 (102 × 76)	1.65 (41.9)
3½ × 3 (89 × 76)	0.87 (22.1)
3½ × 2½ (89 × 64)	1.62 (41.1)
3 × 2½ (76 × 64)	0.86 (21.8)
3 × 2 (76 × 51)	1.56 (39.6)
2½ × 2 (64 × 51)	0.85 (21.6)
2½ × 1½ (64 × 38)	1.49 (37.8)
Equal legs	0.00

* $\beta_w = \frac{1}{I_w} \int_A z(w^2 + z^2) dA - 2z_o$
 where
 z_o = coordinate along the z-axis of the shear center with respect to the centroid, in. (mm)
 I_w = moment of inertia for the major principal axis, in.⁴ (mm⁴)
 β_w has a positive or negative value depending on the direction of bending (see Figure C-F10.4).

stresses will vary along the leg length permitting the use of the stress limits given. Even for the geometric axis flexure case, which produces uniform compression along one leg, use of these limits will provide a conservative value when compared to the results reported in Earls and Galambos (1997).

F11. RECTANGULAR BARS AND ROUNDS

The provisions in Section F11 apply to solid bars with round and rectangular cross section. The prevalent limit state for such members is the attainment of the full plastic moment, M_p . The exception is the lateral-torsional buckling of rectangular bars where the depth is larger than the width. The requirements for design are identical to those given previously in Table A-F1.1 in the 1999 LRFD Specification and the same as those given in the 2005 *Specification for Structural Steel Buildings* (AISC, 2005a). Since the shape factor for a rectangular cross section is 1.5 and for a round section is 1.7, consideration must be given to serviceability issues such as excessive deflection or permanent deformation under service-load conditions.

F12. UNSYMMETRICAL SHAPES

When the design engineer encounters beams that do not contain an axis of symmetry, or any other shape for which there are no provisions in the other sections of Chapter F, the stresses are to be limited by the yield stress or the elastic buckling stress. The stress distribution and/or the elastic buckling stress must be determined from principles of structural mechanics, textbooks or handbooks, such as the SSRC Guide (Zieman, 2010), papers in journals, or finite element analyses. Alternatively, the designer can avoid the problem by selecting cross sections from among the many choices given in the previous sections of Chapter F.

F13. PROPORTIONS OF BEAMS AND GIRDERS

1. Strength Reductions for Members with Holes in the Tension Flange

Historically, provisions for proportions of rolled beams and girders with holes in the tension flange were based upon either a percentage reduction independent of material strength or a calculated relationship between the tension rupture and tension yield strengths of the flange, with resistance factors or safety factors included in the calculation. In both cases, the provisions were developed based upon tests of steel with a specified minimum yield stress of 36 ksi (250 MPa) or less.

More recent tests (Dexter and Altstadt, 2004; Yuan et al., 2004) indicate that the flexural strength on the net section is better predicted by comparison of the quantities $F_y A_{fg}$ and $F_u A_{fn}$, with slight adjustment when the ratio of F_y to F_u exceeds 0.8. If the holes remove enough material to affect the member strength, the critical stress is adjusted from F_y to $(F_u A_{fn}/A_{fg})$ and this value is conservatively applied to the elastic section modulus, S_x .

The resistance factor and safety factor used throughout this chapter, $\phi = 0.90$ and $\Omega = 1.67$, are those normally applied for the limit state of yielding. In the case of rupture of the tension flange due to the presence of holes, the provisions of this chapter continue to apply the same resistance and safety factors. Since the effect of Equation F13-1 is to multiply the elastic section modulus by a stress that is always less than the yield stress, it can be shown that this resistance and safety factor always give conservative results when $Z/S \leq 1.2$. It can also be shown to be conservative when $Z/S > 1.2$ and a more accurate model for the rupture strength is used (Geschwindner, 2010a).

2. Proportioning Limits for I-Shaped Members

The provisions of this section were taken directly from Appendix G Section G1 of the 1999 LRFD Specification and are the same as the 2005 *Specification for Structural Steel Buildings* (AISC, 2005a). They have been part of the plate-girder design requirements since 1963 and are derived from Basler and Thürlimann (1963). The web depth-to-thickness limitations are provided so as to prevent the flange from buckling into the web. Equation F13-4 was slightly modified from the corresponding Equation A-G1-2 in the 1999 LRFD Specification to recognize the change in the definition of residual stress from a constant 16.5 ksi (114 MPa) to 30% of the yield stress in the 2005 Specification, as shown by the following derivation:

$$\frac{0.48E}{\sqrt{F_y(F_y + 16.5)}} \approx \frac{0.48E}{\sqrt{F_y(F_y + 0.3F_y)}} = \frac{0.42E}{F_y} \quad (\text{C-F13-1})$$

3. Cover Plates

Cover plates need not extend the entire length of the beam or girder. The end connection between the cover plate and beam must be designed to resist the full force in the cover plate at the theoretical cutoff point. The end force in a cover plate on a beam whose required strength exceeds the available yield strength, $\phi M_y = \phi F_y S_x$ (LRFD) or $M_y/\Omega = F_y S_x/\Omega$ (ASD), of the combined shape can be determined by an elastic-plastic analysis of the cross section but can conservatively be taken as the full yield strength of the cover plate for LRFD or the full yield strength of the cover plate divided by 1.5 for ASD. The forces in a cover plate on a beam whose required strength does not exceed the available yield strength of the combined section can be determined using the elastic distribution, MQ/I .

The requirements for minimum weld lengths on the sides of cover plates at each end reflect uneven stress distribution in the welds due to shear lag in short connections.

5. Unbraced Length for Moment Redistribution

The moment redistribution provisions of Section B3.7 refer to this section for setting the maximum unbraced length when moments are to be redistributed. These provisions have been a part of the Specification since the 1949 edition. Portions of members that would be required to rotate inelastically while the moments are redistributed need more closely spaced bracing than similar parts of a continuous beam. Equations F13-8 and F13-9 define the maximum permitted unbraced length in the vicinity of redistributed moment for doubly symmetric and singly symmetric I-shaped members with a compression flange equal to or larger than the tension flange bent about their major axis, and for solid rectangular bars and symmetric box beams bent about their major axis, respectively. These equations are identical to those in Appendix 1 of the 2005 *Specification for Structural Steel Buildings* (AISC, 2005a) and the 1999 LRFD Specification, and are based on research reported in Yura et al. (1978). They are different from the corresponding equations in Chapter N of the 1989 *Specification for Structural Steel Buildings—Allowable Stress Design and Plastic Design* (AISC, 1989).

CHAPTER G

DESIGN OF MEMBERS FOR SHEAR

G1. GENERAL PROVISIONS

Chapter G applies to webs of singly or doubly symmetric members subject to shear in the plane of the web, single angles and HSS, and shear in the weak direction of singly or doubly symmetric shapes.

Two methods for determining the shear strength of singly or doubly symmetric I-shaped beams and built-up sections are presented. The method of Section G2 does not utilize the post-buckling strength of the web, while the method of Section G3 utilizes the post-buckling strength.

G2. MEMBERS WITH UNSTIFFENED OR STIFFENED WEBS

Section G2 deals with the shear strength of webs of wide-flange or I-shaped members, as well as webs of tee-shapes, that are subject to shear and bending in the plane of the web. The provisions in Section G2 apply to the general case when an increase of strength due to tension field action is not permitted. Conservatively, these provisions may be applied also when it is not desired to use the tension field action enhancement for convenience in design. Consideration of the effect of bending on the shear strength is not required because the effect is deemed negligible.

1. Shear Strength

The nominal shear strength of a web is defined by Equation G2-1, a product of the shear yield force, $0.6F_yA_w$, and the shear-buckling reduction factor, C_v .

The provisions of Case (a) in Section G2.1 for rolled I-shaped members with $h/t_w \leq 2.24\sqrt{E/F_y}$ are similar to the 1999 and earlier LRFD provisions, with the exception that ϕ has been increased from 0.90 to 1.00 (with a corresponding decrease of the safety factor from 1.67 to 1.50), thus making these provisions consistent with the 1989 provisions for allowable stress design (AISC, 1989). The value of ϕ of 1.00 is justified by comparison with experimental test data and recognizes the minor consequences of shear yielding, as compared to those associated with tension and compression yielding, on the overall performance of rolled I-shaped members. This increase is applicable only to the shear yielding limit state of rolled I-shaped members.

Case (b) in Section G2.1 uses the shear buckling reduction factor, C_v , shown in Figure C-G2.1. The curve for C_v has three segments.

For webs with $h/t_w \leq 1.10\sqrt{k_v E / F_{yw}}$, the nominal shear strength, V_n , is based on shear yielding of the web, with C_v given by Equation G2-3. This h/t_w limit was

determined by setting the critical stress causing shear buckling, F_{cr} , equal to the yield stress of the web, $F_{yw} = F_y$, in Equation 35 of Cooper et al. (1978).

When $h/t_w > 1.10\sqrt{k_v E / F_{yw}}$, the web shear strength is based on buckling. It has been suggested to take the proportional limit as 80% of the yield stress of the web (Basler, 1961). This corresponds to $h/t_w = (1.10/0.8)\left(\sqrt{k_v E / F_{yw}}\right)$.

When $h/t_w > 1.37\sqrt{k_v E / F_{yw}}$, the web strength is determined from the elastic buckling stress given by Equation 6 of Cooper et al. (1978) and Equation 9-7 in Timoshenko and Gere (1961):

$$F_{cr} = \frac{\pi^2 E k_v}{12(1-\nu^2)(h/t_w)^2} \quad (\text{C-G2-1})$$

C_v in Equation G2-5 was obtained by dividing F_{cr} from Equation C-G2-1 by $0.6F_y$ and using $\nu = 0.3$.

The inelastic buckling transition for C_v (Equation G2-4) is used between the limits given by $1.10\sqrt{k_v E / F_y} < h/t_w \leq 1.37\sqrt{k_v E / F_y}$.

The plate buckling coefficient, k_v , for panels subject to pure shear having simple supports on all four sides is given by Equation 4.3 in Ziemian (2010).

$$k_v = \left\{ \begin{array}{ll} 4.00 + \frac{5.34}{(a/h)^2} & \text{for } a/h \leq 1 \\ 5.34 + \frac{4.00}{(ah)^2} & \text{for } a/h > 1 \end{array} \right\} \quad (\text{C-G2-2})$$

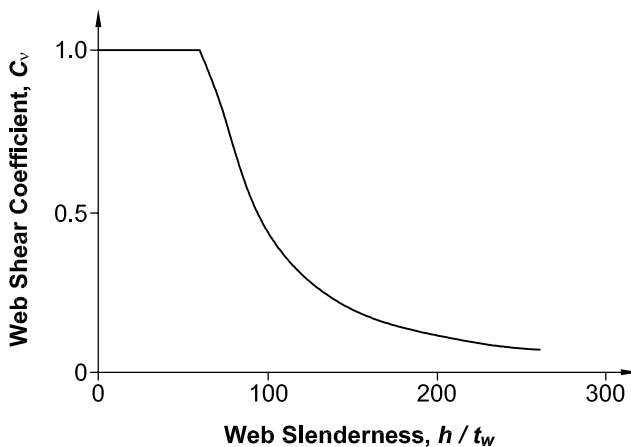

Fig. C-G2.1. Shear buckling coefficient C_v for $F_y = 50$ ksi (345 MPa) and $k_v = 5.0$.

For practical purposes and without loss of accuracy, these equations have been simplified herein and in AASHTO (2010) to

$$k_v = 5 + \frac{5}{(a/h)^2} \quad (\text{C-G2-3})$$

When the panel ratio, a/h , becomes large, as in the case of webs without transverse stiffeners, then $k_v = 5$. Equation C-G2-3 applies as long as there are flanges on both edges of the web. For tee-shaped beams, the free edge is unrestrained and for this situation $k_v = 1.2$ (JCRC, 1971).

The provisions of Section G2.1 assume monotonically increasing loads. If a flexural member is subjected to load reversals causing cyclic yielding over large portions of a web, such as may occur during a major earthquake, special design considerations may apply (Popov, 1980).

2. Transverse Stiffeners

When transverse stiffeners are needed, they must be rigid enough to cause a buckling node line to form at the stiffener. This requirement applies whether or not tension field action is counted upon. The required moment of inertia of the stiffener is the same as in AASHTO (2010), but it is different from the formula in the 1989 *Specification for Structural Steel Buildings—Allowable Stress Design* (AISC, 1989). Equation G2-7 is derived in Chapter 11 of Salmon and Johnson (1996). The origin of the formula can be traced to Bleich (1952).

G3. TENSION FIELD ACTION

The provisions of Section G3 apply when it is intended to account for the enhanced strength of webs of built-up members due to tension field action.

1. Limits on the Use of Tension Field Action

The panels of the web of a built-up member, bounded on the top and bottom by the flanges and on each side by the transverse stiffeners, are capable of carrying loads far in excess of their “web buckling” load. Upon reaching the theoretical web buckling limit, slight lateral web displacements will have developed. These deformations are of no structural significance, because other means are still present to provide further strength.

When transverse stiffeners are properly spaced and are stiff enough to resist out-of-plane movement of the postbuckled web, significant diagonal tension fields form in the web panels prior to the shear resistance limit. The web in effect acts like a Pratt truss composed of tension diagonals and compression verticals that are stabilized by the transverse stiffeners. This effective Pratt truss furnishes the strength to resist applied shear forces unaccounted for by the linear buckling theory.

The key requirement in the development of tension field action in the web of plate girders is the ability of the stiffeners to provide sufficient flexural rigidity to stabilize the web along their length. In the case of end panels there is a panel only on one side. The anchorage of the tension field is limited in many situations at these locations and

is thus neglected. In addition, the enhanced resistance due to tension field forces is reduced when the panel aspect ratio becomes large. For this reason the inclusion of tension field action is not permitted when a/h exceeds 3.0 or $[260/(h/t_w)]^2$.

AISC Specifications prior to 2005 have required explicit consideration of the interaction between the flexural and shear strengths when the web is designed using tension field action. White et al. (2008) show that the interaction between the shear and flexural resistances is negligible when the requirements $2A_w/(A_{fc} + A_{ft}) \leq 2.5$ and $h/b_f \leq 6$ are satisfied. Section G3.1 disallows the use of tension field action for I-section members with relatively small flange-to-web proportions identified by these limits. Similar limits are specified in AASHTO (2010); furthermore, AASHTO (2010) allows the use of a reduced “true Basler” tension field resistance for cases where these limits are violated.

2. Shear Strength with Tension Field Action

Analytical methods based on tension field action have been developed (Basler and Thürlimann, 1963; Basler, 1961) and corroborated in an extensive program of tests (Basler et al., 1960). Equation G3-2 is based on this research. The second term in the bracket represents the relative increase of the panel shear strength due to tension field action. The merits of Equation G3-2 relative to various alternative representations of web shear resistance are evaluated and Equation G3-2 is recommended in White and Barker (2008).

3. Transverse Stiffeners

The vertical component of the tension field force that is developed in the web panel must be resisted by the transverse stiffener. In addition to the rigidity required to keep the line of the stiffener as a nonmoving point for the buckled panel, as provided for in Section G2.2, the stiffener must also have a large enough area to resist the tension field reaction.

Numerous studies (Horne and Grayson, 1983; Rahal and Harding, 1990a, 1990b, 1991; Stanway et al., 1993, 1996; Lee et al., 2002b; Xie and Chapman, 2003; Kim et al., 2007) have shown that transverse stiffeners in I-girders designed for tension field action are loaded predominantly in bending due to the restraint they provide to lateral deflection of the web. Generally, there is evidence of some axial compression in the transverse stiffeners due to the tension field, but even in the most slender web plates permitted by this Specification; the effect of the axial compression transmitted from the postbuckled web plate is typically minor compared to the lateral loading effect. Therefore, the transverse stiffener area requirement from prior Specifications is no longer specified. Rather, the demands on the stiffener flexural rigidity are increased in situations where the tension field action of the web is developed. Equation G3-4 is the same requirement as specified in AASHTO (2010).

G4. SINGLE ANGLES

Shear stresses in single-angle members are the result of the gradient of the bending moment along the length (flexural shear) and the torsional moment.

The maximum elastic stress due to flexural shear is

$$f_v = \frac{1.5V_b}{bt} \quad (\text{C-G4-1})$$

where V_b is the component of the shear force parallel to the angle leg with width b and thickness t . The stress is constant throughout the thickness, and it should be calculated for both legs to determine the maximum. The coefficient 1.5 is the calculated value for equal leg angles loaded along one of the principal axes. For equal leg angles loaded along one of the geometric axes, this factor is 1.35. Factors between these limits may be calculated conservatively from $V_b Q/It$ to determine the maximum stress at the neutral axis. Alternatively, if only flexural shear is considered, a uniform flexural shear stress in the leg of V_b/bt may be used due to inelastic material behavior and stress redistribution.

If the angle is not laterally braced against twist, a torsional moment is produced equal to the applied transverse load times the perpendicular distance, e , to the shear center, which is at the point of intersection of the centerlines of the two legs. Torsional moments are resisted by two types of shear behavior: pure torsion (*St. Venant torsion*) and *warping torsion* [see Seaburg and Carter (1997)]. The shear stresses due to restrained warping are small compared to the St. Venant torsion (typically less than 20%) and they can be neglected for practical purposes. The applied torsional moment is then resisted by pure shear stresses that are constant along the width of the leg (except for localized regions at the toe of the leg), and the maximum value can be approximated by

$$f_v = \frac{M_T t}{J} = \frac{3M_T}{At} \quad (\text{C-G4-2})$$

where

A = angle cross-sectional area, in.² (mm²)

J = torsional constant [approximated by $\Sigma(bt^3/3)$ when precomputed value is unavailable], in.⁴ (mm⁴)

M_T = torsional moment, kip-in. (N-mm)

For a study of the effects of warping, see Gjelsvik (1981). Torsional moments from laterally unrestrained transverse loads also produce warping normal stresses that are superimposed on the bending stresses. However, since the warping strength of single angles is relatively small, this additional bending effect, just like the warping shear effect, can be neglected for practical purposes.

G5. RECTANGULAR HSS AND BOX-SHAPED MEMBERS

The two webs of a closed rectangular cross section resist shear the same way as the single web of an I-shaped plate girder or wide-flange beam, and therefore, the provisions of Section G2 apply.

G6. ROUND HSS

Little information is available on round HSS subjected to transverse shear and the recommendations are based on provisions for local buckling of cylinders due to torsion. However, since torsion is generally constant along the member length and transverse shear usually has a gradient; it is recommended to take the critical stress for transverse shear as 1.3 times the critical stress for torsion (Brockenbrough and Johnston, 1981; Ziemian, 2010). The torsion equations apply over the full length of the member, but for transverse shear it is reasonable to use the length between the points of maximum and zero shear force. Only thin HSS may require a reduction in the shear strength based upon first shear yield. Even in this case, shear will only govern the design of round HSS for the case of thin sections with short spans.

In the equation for the nominal shear strength, V_n , of round HSS, it is assumed that the shear stress at the neutral axis, calculated as VQ/Ib , is at F_{cr} . For a thin round section with radius R and thickness t , $I = \pi R^3 t$, $Q = 2R^2 t$ and $b = 2t$. This gives the stress at the centroid as $V/\pi R t$, in which the denominator is recognized as half the area of the round HSS.

G7. WEAK AXIS SHEAR IN DOUBLY SYMMETRIC AND SINGLY SYMMETRIC SHAPES

The nominal weak axis shear strength of doubly and singly symmetric I-shapes is governed by the equations of Section G2 with the plate buckling coefficient equal to $k_v = 1.2$, the same as the web of a tee-shape. The maximum plate slenderness of all rolled shapes is $b/t_f = b_f/2t_f = 13.8$, and for $F_y = 100$ ksi (690 MPa) the value of $1.10\sqrt{k_v E / F_y} = 1.10\sqrt{(1.2)(29,000 \text{ ksi}) / 100} = 20.5$. Thus $C_v = 1.0$, except for built-up shapes with very slender flanges.

G8. BEAMS AND GIRDERS WITH WEB OPENINGS

Web openings in structural floor members may be used to accommodate various mechanical, electrical and other systems. Strength limit states, including local buckling of the compression flange or of the web, local buckling or yielding of the tee-shaped compression zone above or below the opening, lateral buckling and moment-shear interaction, or serviceability may control the design of a flexural member with web openings. The location, size and number of openings are important and empirical limits for them have been identified. One general procedure for assessing these effects and the design of any needed reinforcement for both steel and composite beams is given in the ASCE *Specification for Structural Steel Beams with Web Openings* (ASCE, 1999), with background information provided in AISC Design Guide 2 by Darwin (1990) and in ASCE Task Committee on Design Criteria for Composite Structures in Steel and Concrete (1992a, 1992b).

CHAPTER H

DESIGN OF MEMBERS FOR COMBINED FORCES AND TORSION

Chapters D, E, F and G of this Specification address members subject to only one type of force: axial tension, axial compression, flexure and shear, respectively. Chapter H addresses members subject to a combination of two or more of the individual forces defined above, as well as possibly by additional forces due to torsion. The provisions fall into two categories: (a) the majority of the cases that can be handled by an interaction equation involving sums of ratios of required strengths to the available strengths; and (b) cases where the stresses due to the applied forces are added and compared to limiting buckling or yield stresses. Designers will have to consult the provisions of Sections H2 and H3 only in rarely occurring cases.

H1. DOUBLY AND SINGLY SYMMETRIC MEMBERS SUBJECT TO FLEXURE AND AXIAL FORCE

1. Doubly and Singly Symmetric Members Subject to Flexure and Compression

Section H1 contains design provisions for doubly symmetric and singly symmetric members under combined flexure and compression and under combined flexure and tension. The provisions of Section H1 apply typically to rolled wide-flange shapes, channels, tee-shapes, round, square and rectangular HSS, solid rounds, squares, rectangles or diamonds, and any of the many possible combinations of doubly or singly symmetric shapes fabricated from plates and/or shapes by welding or bolting. The interaction equations accommodate flexure about one or both principal axes as well as axial compression or tension.

In 1923, the first AISC Specification required that the stresses due to flexure and compression be added and that the sum not exceed the allowable value. An interaction equation appeared first in the 1936 Specification, stating “Members subject to both axial and bending stresses shall be so proportioned that the quantity $\frac{f_a}{F_a} + \frac{f_b}{F_b}$ shall not exceed unity,” in which F_a and F_b are, respectively, the axial and flexural allowable stresses permitted by this Specification, and f_a and f_b are the corresponding stresses due to the axial force and the bending moment, respectively. This linear interaction equation was in force until the 1961 Specification, when it was modified to account for frame stability and for the P - δ effect, that is, the secondary bending between the ends of the members (Equation C-H1-1). The P - Δ effect, that is, the second-order bending moment due to story sway, was not accommodated.

$$\frac{f_a}{F_a} + \frac{C_m f_b}{\left(1 - \frac{f_a}{F_e'}\right) F_b} \leq 1.0 \quad (\text{C-H1-1})$$

The allowable axial stress, F_a , was determined for an effective length that is larger than unity for moment frames. The term $\frac{1}{1 - \frac{f_a}{F_e}}$ is the amplification of the interspan

moment due to member deflection multiplied by the axial force (the P - δ effect). C_m accounts for the effect of the moment gradient. This interaction equation was part of all the subsequent editions of the AISC ASD Specifications from 1961 through 1989.

A new approach to the interaction of flexural and axial forces was introduced in the 1986 AISC *Load and Resistance Factor Design Specification for Structural Steel Buildings* (AISC, 1986). The following is an explanation of the thinking behind the interaction curves used. The equations

$$\frac{P}{P_y} + \frac{8}{9} \frac{M_{pc}}{M_p} = 1 \quad \text{for } \frac{P}{P_y} \geq 0.2 \quad (\text{C-H1-2a})$$

$$\frac{P}{2P_y} + \frac{M_{pc}}{M_p} = 1 \quad \text{for } \frac{P}{P_y} < 0.2 \quad (\text{C-H1-2b})$$

define the lower-bound curve for the interaction of the nondimensional axial strength, P/P_y , and flexural strength, M_{pc}/M_p , for compact wide-flange *stub-columns* bent about their x -axis. The cross section is assumed to be fully yielded in tension and compression. The symbol M_{pc} is the plastic moment strength of the cross section in the presence of an axial force, P . The curve representing Equations C-H1-2 almost overlaps the analytically exact curve for the major-axis bending of a W8×31 cross section (see Figure C-H1.1). The equations for the exact yield capacity of a wide-flange shape are (ASCE, 1971):

$$\text{For } 0 \leq \frac{P}{P_y} \leq \frac{t_w(d - 2t_f)}{A}$$

$$\frac{M_{pc}}{M_p} = 1 - \frac{A^2 \left(\frac{P}{P_y} \right)^2}{4t_w Z_x} \quad (\text{C-H1-3a})$$

$$\text{For } \frac{t_w(d - 2t_f)}{A} < \frac{P}{P_y} \leq 1$$

$$\frac{M_{pc}}{M_p} = \frac{A \left(1 - \frac{P}{P_y} \right)}{2Z_x} \left[d - \frac{A \left(1 - \frac{P}{P_y} \right)}{2b_f} \right] \quad (\text{C-H1-3b})$$

The equation approximating the average yield strength of wide-flange shapes is

$$\frac{M_{pc}}{M_p} = 1.18 \left(1 - \frac{P}{P_y} \right) \leq 1 \tag{C-H1-4}$$

The curves in Figure C-H1.2 show the exact and approximate yield interaction curves for wide-flange shapes bent about the y-axis, and the exact curves for the solid

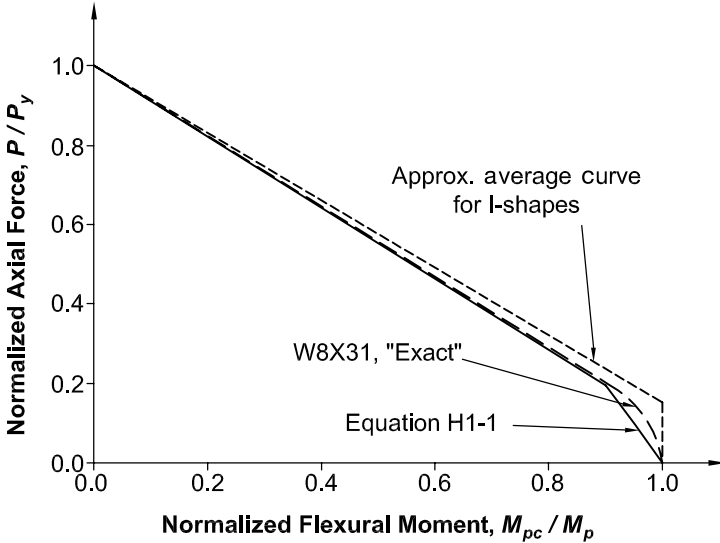

Fig. C-H1.1. Stub-column interaction curves: plastic moment versus axial force for wide-flange shapes, major-axis flexure [W8x31, $F_y = 50 \text{ ksi (345 MPa)}$].

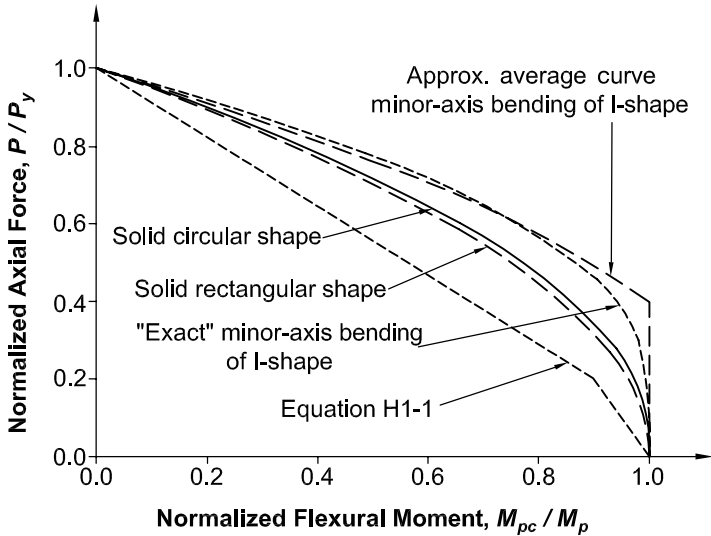

Fig. C-H1.2. Stub-column interaction curves: plastic moment versus axial force for solid round and rectangular sections and for wide-flange shapes, minor-axis flexure.

rectangular and round shapes. It is evident that the lower-bound AISC interaction curves are very conservative for these shapes.

The idea of portraying the strength of stub beam-columns was extended to actual beam-columns with actual lengths by normalizing the required flexural strength, M_u , of the beam by the nominal strength of a beam without axial force, M_n , and the required axial strength, P_u , by the nominal strength of a column without bending moment, P_n . This rearrangement results in a translation and rotation of the original stub-column interaction curve, as seen in Figure C-H1.3.

The normalized equations corresponding to the beam-column with length effects included are shown as Equation C-H1-5:

$$\frac{P_u}{P_n} + \frac{8 M_u}{9 M_n} = 1 \quad \text{for } \frac{P_u}{P_n} \geq 0.2 \quad (\text{C-H1-5a})$$

$$\frac{P_u}{2P_n} + \frac{M_u}{M_n} = 1 \quad \text{for } \frac{P_u}{P_n} < 0.2 \quad (\text{C-H1-5b})$$

The interaction equations are designed to be very versatile. The terms in the denominator fix the endpoints of the interaction curve. The nominal flexural strength, M_n , is determined by the appropriate provisions from Chapter F. It encompasses the limit states of yielding, lateral-torsional buckling, flange local buckling, and web local buckling.

The axial term, P_n , is governed by the provisions of Chapter E, and it can accommodate nonslender or slender element columns, as well as the limit states of major and minor axis buckling, and torsional and flexural-torsional buckling. Furthermore, P_n is calculated for the applicable effective length of the column to take care of frame

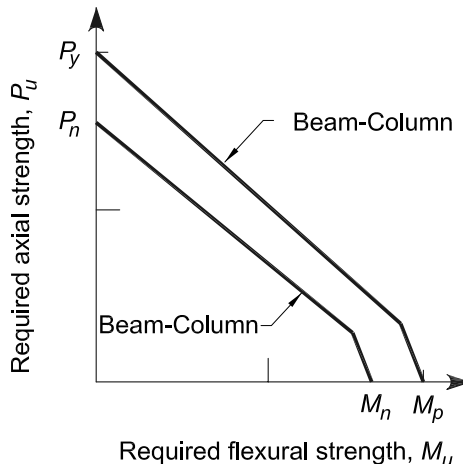

Fig. C-H1.3. Interaction curve for stub beam-column and beam-column.

stability effects, if the procedures of Appendix 7, Section 7.2 are used to determine the required moments and axial forces. These moments and axial forces include the amplification due to second-order effects.

The utility of the interaction equations is further enhanced by the fact that they also permit the consideration of *biaxial bending*.

2. Doubly and Singly Symmetric Members Subject to Flexure and Tension

Section H1.1 considers the most frequently occurring cases in design: members under flexure and axial compression. Section H1.2 addresses the less frequent cases of flexure and axial tension. Since axial tension increases the bending stiffness of the member to some extent, Section H1.2 permits the increase of C_b in Chapter F. Thus, when the bending term is controlled by lateral-torsional buckling, the moment gradient factor, C_b , is increased by $\sqrt{1 + \frac{\alpha P_T}{P_{ey}}}$. For the 2010 Specification, this multiplier

was altered slightly as shown here to use the same constant, α , as is used throughout the Specification when results at the ultimate strength level are required.

3. Doubly Symmetric Rolled Compact Members Subject to Single Axis Flexure and Compression

For doubly symmetric wide-flange sections with moment applied about the x -axis, the bilinear interaction Equation C-H1-5 is conservative for cases where the axial limit state is out-of-plane buckling and the flexural limit state is lateral-torsional buckling (Ziemian, 2010). Section H1.3 gives an optional equation for checking the out-of-plane resistance of such beam-columns.

The two curves labeled Equation H1-1 (out-of-plane) and Equation H1-2 (out-of-plane) in Figure C-H1.4 illustrate the difference between the bilinear and the parabolic interaction equations for out-of-plane resistance for the case of a W27×84 beam-column, $L_b = 10$ ft (3.05 m) and $F_y = 50$ ksi (345 MPa), subjected to a linearly varying strong axis moment with zero moment at one end and maximum moment at the other end ($C_b = 1.67$). In addition, the solid line in the figure shows the in-plane bilinear strength interaction for this member obtained from Equation H1-1. Note that the resistance term $C_b M_{cx}$ may be larger than $\phi_b M_p$ in LRFD and M_p/Ω_b in ASD. The smaller ordinate from the out-of-plane and in-plane resistance curves is the controlling strength.

Equation H1-2 is developed from the following fundamental form for the out-of-plane lateral-torsional buckling strength of doubly-symmetric I-section members, in LRFD:

$$\left(\frac{M_u}{C_b \phi_b M_{nx}(C_b=1)} \right)^2 \leq \left(1 - \frac{P_u}{\phi_c P_{ny}} \right) \left(1 - \frac{P_u}{\phi_c P_{ez}} \right) \quad (\text{C-H1-6})$$

Equation H1-2 is obtained by substituting a lower-bound of 2.0 for the ratio of the elastic torsional buckling resistance to the out-of-plane nominal flexural buckling resistance, P_{e_z}/P_{ny} , for W-shape members with $KL_y = KL_z$. The 2005 Specification assumed an upper bound, $P_{e_z}/P_{ny} = \infty$, in Equation C-H1-6 in the development of Equation H1-2 which leads to some cases where the out-of-plane strength is overestimated. In addition, the fact that the nominal out-of-plane flexural resistance term, $C_b M_{nx}(C_b = 1)$, may be larger than M_p was not apparent in the 2005 Specification.

The relationship between Equations H1-1 and H1-2 is further illustrated in Figures C-H1.5 (for LRFD) and C-H1.6 (for ASD). The curves relate the required axial force, P (ordinate), and the required bending moment, M (abscissa), when the interaction Equations H1-1 and H1-2 are equal to unity. The positive values of P are compression and the negative values are tension. The curves are for a 10 ft (3 m) long W16×26 [$F_y = 50$ ksi (345 MPa)] member subjected to uniform strong axis bending, $C_b = 1$. The solid curve is for in-plane behavior, that is, lateral bracing prevents lateral-torsional buckling. The dotted curve represents Equation H1-1 for the case when there are no lateral braces between the ends of the beam-column. In the

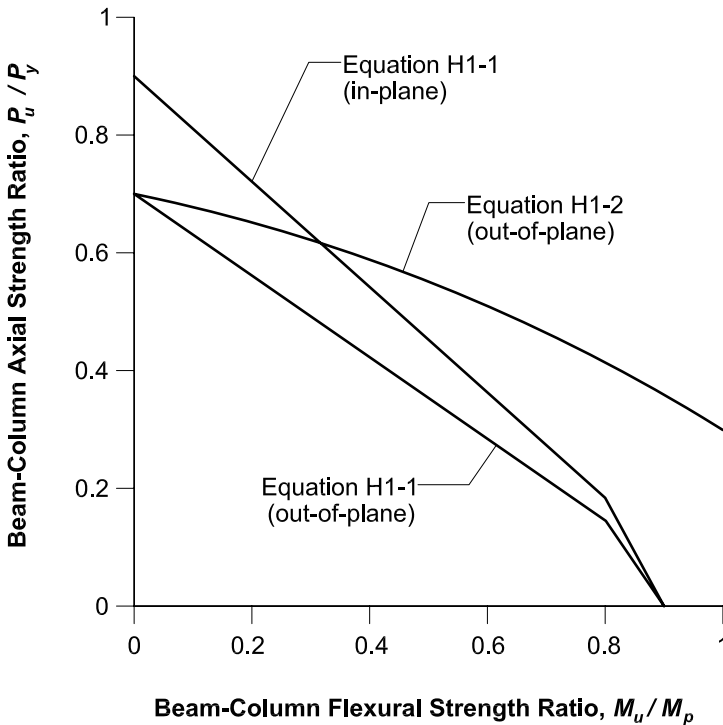

Fig. C-H1.4. Comparison between bilinear (Equation H1-1) and parabolic (Equation H1-2) out-of-plane strength interaction equations and bilinear (Equation H1-1) in-plane strength interaction equation ($W27 \times 84$, $F_y = 50$ ksi, $L_b = 10$ ft, $C_b = 1.75$).

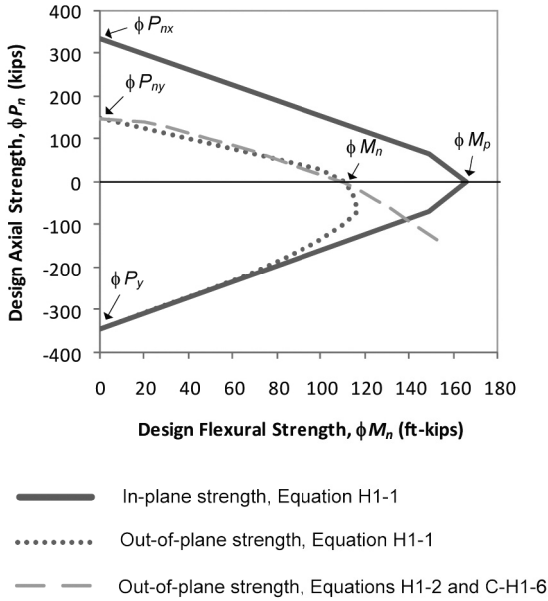

Fig. C-H1.5. Beam-columns under compressive and tensile axial force (tension is shown as negative) (LRFD) (W16×26, $F_y = 50$ ksi, $L_b = 10$ ft, $C_b = 1$).

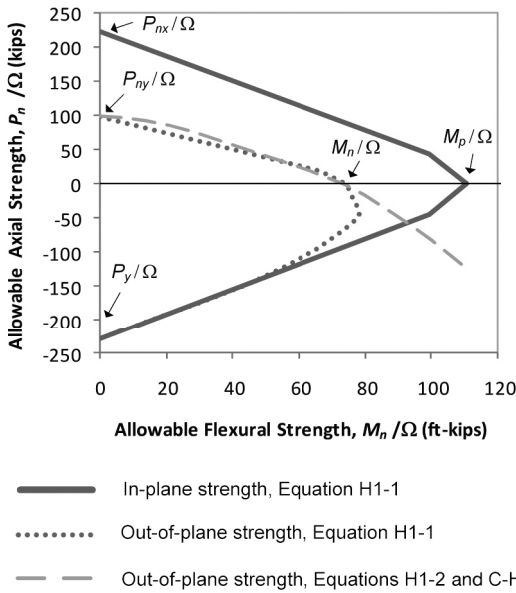

Fig. C-H1.6. Beam-columns under compressive and tensile axial force (tension is shown as negative) (ASD) (W16×26, $F_y = 50$ ksi, $L_b = 10$ ft, $C_b = 1$).

region of the tensile axial force, the curve is modified by the term $\sqrt{1 + \frac{\alpha P_r}{P_{cy}}}$, as permitted in Section H1.2. The dashed curve is Equation H1-2 for the case of axial compression, and it is taken as the lower-bound determined using Equation C-H1-6 with P_{ez}/P_{ny} taken equal to infinity for the case of axial tension. For a given compressive or tensile axial force, Equations H1-2 and C-H1-6 allow a larger bending moment over most of their applicable range.

H2. UNSYMMETRIC AND OTHER MEMBERS SUBJECT TO FLEXURE AND AXIAL FORCE

The provisions of Section H1 apply to beam-columns with cross sections that are either doubly or singly symmetric. However, there are many cross sections that are unsymmetrical, such as unequal leg angles and any number of possible fabricated sections. For these situations, the interaction equations of Section H1 may not be appropriate. The linear interaction $\left| \frac{f_{ra}}{F_{ca}} + \frac{f_{rbw}}{F_{cbw}} + \frac{f_{rbz}}{F_{cbz}} \right| \leq 1.0$ provides a conservative and simple way to deal with such problems. The lower case stresses, f , are the required axial and flexural stresses computed by elastic analysis for the applicable loads, including second-order effects where appropriate, and the upper case stresses, F , are the available stresses corresponding to the limit state of yielding or buckling. The subscripts r and c refer to the required and available stresses respectively while the subscripts w and z refer to the principal axes of the unsymmetric cross section. This Specification leaves the option to the designer to use the Section H2 interaction equation for cross sections that would qualify for the more liberal interaction equation of Section H1.

The interaction equation, Equation H2-1, applies equally to the case where the axial force is in tension. Equation H2-1 was written in stress format as an aid in examining the condition at the various critical locations of the unsymmetric member. For unsymmetrical sections with uniaxial or biaxial flexure, the critical condition is dependent on the resultant direction of the moment. This is also true for singly symmetric members such as for x -axis flexure of tees. The same elastic section properties are used to compute the corresponding required and available flexural stress terms which means that the moment ratio will be the same as the stress ratio.

There are two approaches for using Equation H2-1:

- (a) Strictly using Equation H2-1 for the interaction of the critical moment about each principal axis, there is only one flexural stress ratio term for every critical location since moment and stress ratios are the same as noted above. In this case one would algebraically add the value of each of the ratio terms to obtain the critical condition at one of the extreme fibers.

Using Equation H2-1 is the conservative approach and is recommended for examining members such as single angles. The available flexural stresses at a particular location (tip of short or long leg or at the heel) are based on the yielding limit moment, the local buckling limit moment, or the lateral-torsional

buckling moment consistent with the sign of the required flexural stress. In each case the yield moment should be based on the smallest section modulus about the axis being considered. One would check the stress condition at the tip of the long and short legs and at the heel and find that at one of the locations the stress ratios would be critical.

- (b) For certain load components, where the critical stress can transition from tension at one point on the cross section to compression at another, it may be advantageous to consider two interaction relationships depending on the magnitude of each component. This is permitted by the sentence at the end of Section H2 which permits a more detailed analysis in lieu of Equation H2-1 for the interaction of flexure and tension.

As an example, for a tee with flexure about both the x and y -axes creating tension at the tip of the stem, compression at the flange could control or tension at the stem could control the design. If y -axis flexure is large relative to x -axis flexure, the stress ratio need only be checked for compression at the flange using corresponding design compression stress limits. However, if the y -axis flexure is small relative to the x -axis flexure, then one would check the tensile stress condition at the tip of the stem, this limit being independent of the amount of the y -axis flexure. The two differing interaction expressions are

$$\left| \frac{f_{ra}}{F_{ca}} + \frac{f_{rby}}{F_{cby}} + \frac{f_{rbx}}{F_{cbx}} \right| \leq 1.0 \text{ at tee flange}$$

and

$$\left| \frac{f_{ra}}{F_{ca}} + \frac{f_{rbx}}{F_{cbx}} \right| \leq 1.0 \text{ at tee stem}$$

The interaction diagrams for biaxial flexure of a WT using both approaches are illustrated in Figure C-H2.1.

Another situation in which one could benefit from consideration of more than one interaction relationship occurs when axial tension is combined with a flexural compression limit based on local buckling or lateral-torsional buckling. An example of this is when the stem of a tee in flexural compression is combined with axial tension. The introduction of the axial tension will reduce the compression which imposed the buckling stress limit. With a required large axial tension and a relatively small flexural compression, the design flexural stress could be set at the yield limit at the stem.

$$\left| \frac{f_{ra}}{F_{ca}} + \frac{f_{rbx}}{F_{cbx}} \right| \leq 1.0$$

where F_{cbx} is the flange tension stress based on reaching ϕF_y in the stem. There could be justification for using F_{cbx} equal to ϕF_y in this expression.

This interaction relationship would hold until the interaction between the flexural compression stress at the stem with F_{cbx} based on local or lateral-torsional buckling limit as increased by the axial tension would control.

$$\left| \frac{f_{ra}}{F_{ca}} - \frac{f_{rbx}}{F_{cbx}} \right| \leq 1.0$$

The interaction diagrams for this case, using both approaches, are illustrated in Figure C-H2.2.

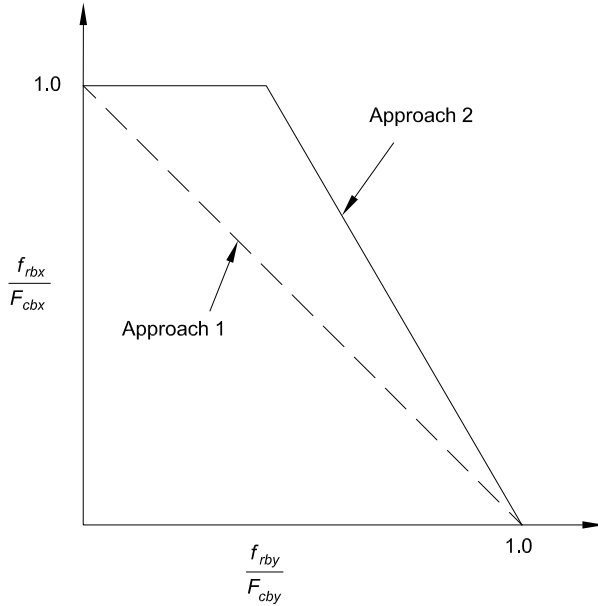

Fig. C-H2.1. WT with biaxial flexure.

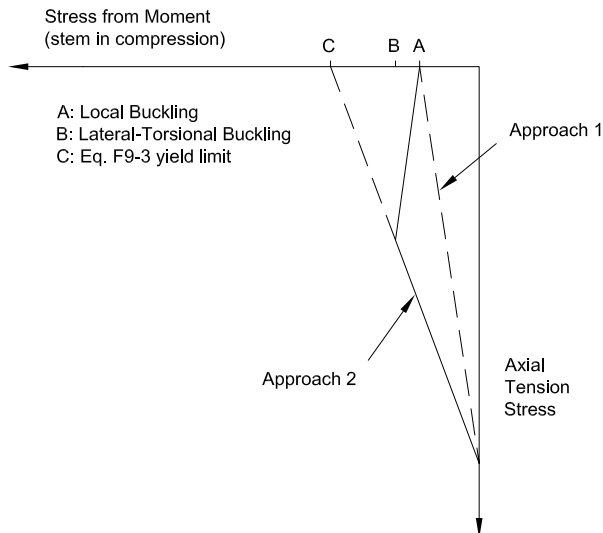

Fig. C-H2.2. WT with flexural compression on the stem plus axial tension.

H3. MEMBERS SUBJECT TO TORSION AND COMBINED TORSION, FLEXURE, SHEAR AND/OR AXIAL FORCE

Section H3 provides provisions for cases not covered in the previous two sections. The first two parts of this section address the design of HSS members, and the third part is a general provision directed to cases where the designer encounters torsion in addition to normal stresses and shear stresses.

1. Round and Rectangular HSS Subject to Torsion

Hollow structural sections (HSS) are frequently used in space-frame construction and in other situations wherein significant torsional moments must be resisted by the members. Because of its closed cross section, an HSS is far more efficient in resisting torsion than an open cross section such as a W-shape or a channel. While normal and shear stresses due to restrained warping are usually significant in shapes of open cross section, they are insignificant in closed cross sections. The total torsional moment can be assumed to be resisted by pure torsional shear stresses. These are often referred in the literature as *St. Venant torsional* stresses.

The pure torsional shear stress in HSS sections is assumed to be uniformly distributed along the wall of the cross section, and it is equal to the torsional moment, T_u , divided by a torsional shear constant for the cross section, C . In a limit state format, the nominal torsional resisting moment is the shear constant times the critical shear stress, F_{cr} .

For round HSS, the torsional shear constant is equal to the polar moment of inertia divided by the radius,

$$C = \frac{\pi(D^4 - D_i^4)}{32D/2} \approx \frac{\pi t(D-t)^2}{2} \quad (\text{C-H3-1})$$

where D_i is the inside diameter.

For rectangular HSS, the torsional shear constant is obtained as $2tA_o$ using the membrane analogy (Timoshenko, 1956), where A_o is the area bounded by the midline of the section. Conservatively assuming an outside corner radius of $2t$, the midline radius is $1.5t$ and

$$A_o = (B-t)(H-t) - 9t^2 \frac{(4-\pi)}{4} \quad (\text{C-H3-2})$$

resulting in

$$C = 2t(B-t)(H-t) - 4.5t^3(4-\pi) \quad (\text{C-H3-3})$$

The resistance factor, ϕ , and the safety factor, Ω , are the same as for flexural shear in Chapter G.

When considering local buckling in round HSS subjected to torsion, most structural members will either be long or of moderate length and the provisions for short

cylinders will not apply. The elastic local buckling strength of long cylinders is unaffected by end conditions and the critical stress is given in Ziemian (2010) as

$$F_{cr} = \frac{K_t E}{\left(\frac{D}{t}\right)^3} \quad (\text{C-H3-4})$$

The theoretical value of K_t is 0.73 but a value of 0.6 is recommended to account for initial imperfections. An equation for the elastic local buckling stress for round HSS of moderate length ($L > 5.1D^2/t$) where the edges are not fixed at the ends against rotation is given in Schilling (1965) and Ziemian (2010) as

$$F_{cr} = \frac{1.23E}{\left(\frac{D}{t}\right)^4 \sqrt{\frac{L}{D}}} \quad (\text{C-H3-5})$$

This equation includes a 15% reduction to account for initial imperfections. The length effect is included in this equation for simple end conditions, and the approximately 10% increase in buckling strength is neglected for edges fixed at the end. A limitation is provided so that the shear yield strength, $0.6F_y$, is not exceeded.

The critical stress provisions for rectangular HSS are identical to the flexural shear provisions of Section G2 with the shear buckling coefficient equal to $k_v = 5.0$. The shear distribution due to torsion is uniform in the longest sides of a rectangular HSS, and this is the same distribution that is assumed to exist in the web of a W-shape beam. Therefore, it is reasonable that the provisions for buckling are the same in both cases.

2. HSS Subject to Combined Torsion, Shear, Flexure and Axial Force

Several interaction equation forms have been proposed in the literature for load combinations that produce both normal and shear stresses. In one common form, the normal and shear stresses are combined elliptically with the sum of the squares (Felton and Dobbs, 1967):

$$\left(\frac{f}{F_{cr}}\right)^2 + \left(\frac{f_v}{F_{ver}}\right)^2 \leq 1 \quad (\text{C-H3-6})$$

In a second form, the first power of the ratio of the normal stresses is used:

$$\left(\frac{f}{F_{cr}}\right) + \left(\frac{f_v}{F_{ver}}\right)^2 \leq 1 \quad (\text{C-H3-7})$$

The latter form is somewhat more conservative, but not overly so (Schilling, 1965), and this is the form used in this Specification:

$$\left(\frac{P_r}{P_c} + \frac{M_r}{M_c}\right) + \left(\frac{V_r}{V_c} + \frac{T_r}{T_c}\right)^2 \leq 1.0 \quad (\text{C-H3-8})$$

where the terms with the subscript r represent the required strengths, and the ones with the subscript c are the corresponding available strengths. Normal effects due to flexural and axial load effects are combined linearly and then combined with the square of the linear combination of flexural and torsional shear effects. When an axial compressive load effect is present, the required flexural strength, M_c , is to be determined by second-order analysis. When normal effects due to flexural and axial load effects are not present, the square of the linear combination of flexural and torsional shear effects underestimates the actual interaction. A more accurate measure is obtained without squaring this combination.

3. Non-HSS Members Subject to Torsion and Combined Stress

This section covers all the cases not previously covered. Examples are built-up unsymmetric crane girders and many other types of odd-shaped built-up cross sections. The required stresses are determined by elastic stress analysis based on established theories of structural mechanics. The three limit states to consider and the corresponding available stresses are:

1. Yielding under normal stress— F_y
2. Yielding under shear stress— $0.6F_y$
3. Buckling— F_{cr}

In most cases it is sufficient to consider normal stresses and shear stresses separately because maximum values rarely occur in the same place in the cross section or at the same place in the span. AISC Design Guide 9, *Torsional Analysis of Structural Steel Members* (Seaburg and Carter, 1997), provides a complete discussion on torsional analysis of open shapes.

H4. RUPTURE OF FLANGES WITH HOLES SUBJECT TO TENSION

Equation H4-1 is provided to evaluate the limit state of tensile rupture of the flanges of beam-columns. This provision is only applicable in cases where there are one or more holes in the flange in net tension under the combined effect of flexure and axial forces. When both the axial and flexural stresses are tensile, their effects are additive. When the stresses are of opposite sign, the tensile effect is reduced by the compression effect.

CHAPTER I

DESIGN OF COMPOSITE MEMBERS

Chapter I includes the following major changes and additions in this edition of the Specification:

1. Concrete and Steel Reinforcement Detailing (Sections I1, I2 and I8): References to ACI 318 (ACI, 2008) are made in Sections I1.1 and I2.1 to invoke requirements for concrete and steel reinforcement requirements. References to ACI 318 are also made in Section I8.3 to invoke requirements for concrete strength of steel headed stud anchors.
2. Local Buckling Provisions (Section I1.2 and I1.4): New provisions are added for local buckling in Sections I1.2 and I1.4. These requirements also lead to new provisions for axial compression and flexural design of filled composite members that are compact, noncompact and slender as addressed in Sections I2.2 and I3.4.
3. Minimum Axial Strength for Composite Compression Members (Sections I2.1 and I2.2): These sections specify that the axial strength of an encased composite compression member and a filled composite compression member need not be less than the strength of a bare steel compression member according to the provisions of Chapter E using the same steel section as the composite member.
4. Load Transfer in Composite Members (Sections I3 and I6): New material is added and revisions are made to the load transfer requirements in composite components. The expanded scope of this section has warranted the creation of a new dedicated section for load transfer in composite members.
5. Reliability of Strength for Encased and Filled Composite Beams (Sections I3.3 and I3.4): The resistance factor and safety factor for encased and filled composite beams were adjusted based upon assessment of new data.
6. Design for Shear (Section I4): All provisions for shear design of composite members are consolidated in a new Section I4.
7. Design of Composite Beam-Columns (Section I5): Clarification of composite beam-column design methods is covered in Section I5.
8. Diaphragms and Collector Beams (Section I7): Performance language has been added in a new Section I7 that covers the design and detailing of composite diaphragms and collector beams. Supplemental information is provided in the Commentary as guidance to designers.
9. Steel Anchors (Section I8): New provisions covering the design of steel anchors (both headed studs and hot rolled channels) are included in Section I8. Provisions for composite beams with slabs remain essentially unchanged except for edits that were made for consistency with the new provisions. Provisions are added in Section I8.2 for edge distances of stud anchors along the axis of a composite beam for normal and lightweight concrete. New steel anchor provisions for shear, tension, and interaction of shear and tension are also provided for other forms of composite construction. These changes propose new terminology to be consistent with the more general provisions on anchorage in ACI 318 Appendix D (ACI, 2008). Specifically, the term “shear

connector” is replaced by the generic term “steel anchor.” Steel anchors in the Specification can refer either to steel “headed stud anchors” or hot-rolled steel “channel anchors.”

II. GENERAL PROVISIONS

Design of composite sections requires consideration of both steel and concrete behavior. These provisions were developed with the intent both to minimize conflicts between current steel and concrete design and detailing provisions and to give proper recognition to the advantages of composite design.

As a result of the attempt to minimize design conflicts, this Specification uses a cross-sectional strength approach for compression member design consistent with that used in reinforced concrete design (ACI, 2008). This approach, in addition, results in a consistent treatment of cross-sectional strengths for both composite columns and beams.

The provisions in Chapter I address strength design of the composite sections only. The designer needs to consider the loads resisted by the steel section alone when determining load effects during the construction phase. The designer also needs to consider deformations throughout the life of the structure and the appropriate cross section for those deformations. When considering these latter limit states, due allowance should be made for the additional long-term changes in stresses and deformations due to creep and shrinkage of the concrete.

1. Concrete and Steel Reinforcement

Reference is made to ACI 318 (ACI, 2008) for provisions related to the concrete and reinforcing steel portion of composite design and detailing, such as anchorage and splice lengths, intermediate column ties, reinforcing spirals, and shear and torsion provisions.

Exceptions and limitations are provided as follows:

- (1) The composite design procedures of ACI 318 have remained unchanged for many years. It was therefore decided to exclude the composite design sections of ACI 318 to take advantage of recent research (Ziemian, 2010; Hajjar, 2000; Shanmugam and Lakshmi, 2001; Leon et al., 2007; Varma and Zhang, 2009; Jacobs and Goverdhan, 2010) into composite behavior that is reflected in the Specification.
- (2) Concrete limitations in addition to those given in ACI 318 are provided to reflect the applicable range of test data on composite members. See also Commentary Section II.3.
- (3) ACI provisions for tie reinforcing of noncomposite reinforced concrete compression members shall be followed in addition to the provisions specified in Section I2.1a(2). See also Commentary Section I2.1a(2).
- (4) The limitation of $0.01A_g$ in ACI 318 for the minimum longitudinal reinforcing ratio of reinforced concrete compression members is based upon the phenomena of stress transfer under service load levels from the concrete to the reinforcement due to creep and shrinkage. The inclusion of an encased structural steel section

meeting the requirements of Section I2.1a aids in mitigating this effect and consequently allows a reduction in minimum longitudinal reinforcing requirements. See also Commentary Section I2.1a(3).

The design basis for ACI 318 is strength design. Designers using allowable stress design for steel design must be conscious of the different load factors between the two specifications.

2. Nominal Strength of Composite Sections

The strength of composite sections shall be computed based on either of the two approaches presented in this Specification. One is the strain compatibility approach, which provides a general calculation method. The other is the plastic stress distribution approach, which is a subset of the strain compatibility approach. The plastic stress distribution method provides a simple and convenient calculation method for the most common design situations, and is thus treated first. Limited use of the elastic stress distribution method is retained for calculation of composite beams with noncompact webs.

2a. Plastic Stress Distribution Method

The plastic stress distribution method is based on the assumption of linear strain across the cross section and elasto-plastic behavior. It assumes that the concrete has reached its crushing strength in compression at a strain of 0.003 and a corresponding stress (typically $0.85f'_c$) on a rectangular stress block, and that the steel has exceeded its yield strain, taken as F_y/E_s .

Based on these simple assumptions, the cross-sectional strength for different combinations of axial force and bending moment may be approximated for typical composite compression member cross sections. The actual interaction diagram for moment and axial force for a composite section based on a plastic stress distribution is similar to that of a reinforced concrete section as shown in Figure C-II.1. As a simplification, for concrete-encased sections a conservative linear interaction between

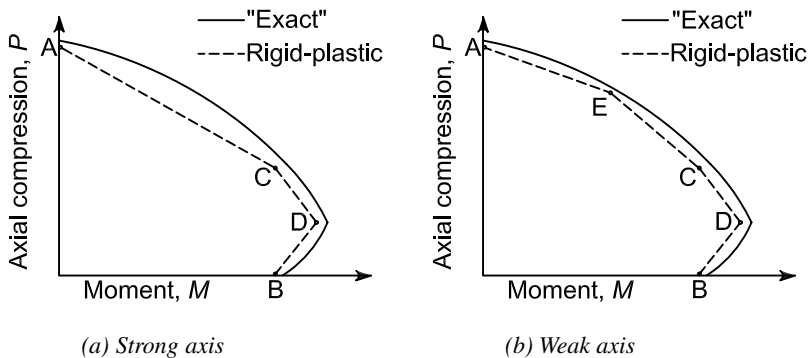

Fig. C-II.1. Comparison between exact and simplified moment-axial compressive force envelopes.

four or five anchor points, depending on axis of bending, can be used (Roik and Bergmann, 1992; Ziemian, 2010). These points are identified as A, B, C, D and E in Figure C-11.1.

The plastic stress approach for compression members assumes that no slip has occurred between the steel and concrete portions and that the required width-to-thickness ratios prevent local buckling from occurring until some yielding and concrete crushing have taken place. Tests and analyses have shown that these are reasonable assumptions for both concrete-encased steel sections with steel anchors and for HSS sections that comply with these provisions (Ziemian, 2010; Hajjar, 2000; Shanmugam and Lakshmi, 2001; Varma et al. 2002; Leon et al., 2007). For round HSS, these provisions allow for the increase of the usable concrete stress to $0.95f'_c$ for calculating both axial compressive and flexural strengths to account for the beneficial effects of the restraining hoop action arising from transverse confinement (Leon et al., 2007).

Based on similar assumptions, but allowing for slip between the steel beam and the composite slab, simplified expressions can also be derived for typical composite beam sections. Strictly speaking, these distributions are not based on slip, but on the strength of the shear connection. Full interaction is assumed if the shear connection strength exceeds that of either (a) the tensile yield strength of the steel section or the compressive strength of the concrete slab when the composite beam is loaded in positive moment, or (b) the tensile yield strength of the longitudinal reinforcing bars in the slab or the compressive strength of the steel section when loaded in negative moment. When steel anchors are provided in sufficient numbers to fully develop this flexural strength, any slip that occurs prior to yielding has a negligible affect on behavior. When full interaction is not present, the beam is said to be partially composite. The effects of slip on the elastic properties of a partially composite beam can be significant and should be accounted for, if significant, in calculations of deflections and stresses at service loads. Approximate elastic properties of partially composite beams are given in Commentary Section I3.

2b. Strain Compatibility Method

The principles used to calculate cross-sectional strength in Section 11.2a may not be applicable to all design situations or possible cross sections. As an alternative, Section 11.2b permits the use of a generalized strain-compatibility approach that allows the use of any reasonable strain-stress model for the steel and concrete.

3. Material Limitations

The material limitations given in Section 11.3 reflect the range of material properties available from experimental testing (Ziemian, 2010; Hajjar, 2000; Shanmugam and Lakshmi, 2001; Varma et al., 2002; Leon et al., 2007). As for reinforced concrete design, a limit of 10 ksi (70 MPa) is imposed for strength calculations, both to reflect the scant data available above this strength and the changes in behavior observed (Varma et al., 2002). A lower limit of 3 ksi (21 MPa) is specified for both normal and lightweight concrete and an upper limit of 6 ksi (42 MPa) is specified for lightweight concrete to encourage the use of good quality, yet readily available, grades of struc-

tural concrete. The use of higher strengths in computing the modulus of elasticity is permitted, and the limits given can be extended for strength calculations if appropriate testing and analyses are carried out.

4. Classification of Filled Composite Sections for Local Buckling

The behavior of filled composite members is fundamentally different from the behavior of hollow steel members. The concrete infill has a significant influence on the stiffness, strength and ductility of composite members. As the steel section area decreases, the concrete contribution becomes even more significant.

The elastic local buckling of the steel tube is influenced significantly by the presence of the concrete infill. The concrete infill changes the buckling mode of the steel tube (both within the cross section and along the length of the member) by preventing it from deforming inwards. For example, see Figures C-II.2 and C-II.3. Bradford et al. (1998) analyzed the elastic local buckling behavior of filled composite compression members, showing that for rectangular steel tubes, the plate buckling coefficient (i.e., k -factor) in the elastic plate buckling equation (Ziemian,

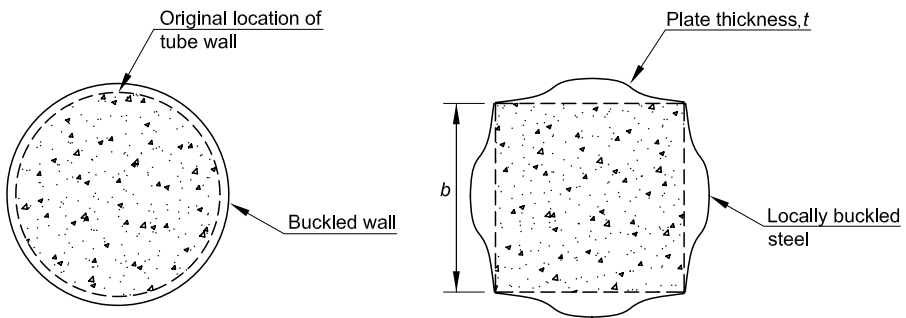

Fig. C-II.2. Change in cross-sectional buckling mode due to concrete infill.

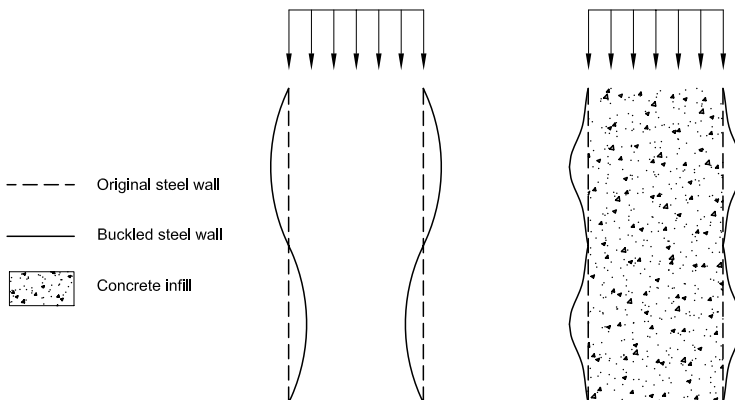

Fig. C-II.3. Changes in buckling mode with length due to the presence of infill.

2010) changes from 4.00 (for hollow tubes) to 10.6 (for filled sections). As a result, the elastic plate buckling stress increases by a factor of 2.65 for filled sections as compared to hollow structural sections. Similarly, Bradford et al. (2002) showed that the elastic local buckling stress for filled round sections is 1.73 times that for hollow round sections.

For rectangular filled sections, the elastic local buckling stress, F_{cr} , from the plate buckling equation simplifies to Equation I2-10. This equation indicates that yielding will occur for plates with b/t less than or equal to $3.00\sqrt{E_s / F_y}$, which designates the limit between noncompact and slender sections, λ_r . This limit does not account for the effects of *residual stresses* or geometric imperfections because the concrete contribution governs for these larger b/t ratios and the effects of reducing steel stresses is small. The maximum permitted b/t value for λ_p is based on the lack of experimental data above the limit of $5.00\sqrt{E_s / F_y}$, and the potential effects (plate deflections and locked-in stresses) of concrete placement in extremely slender filled HSS cross sections. For flexure, the b/t limits for the flanges are the same as those for walls in axial compression due to the similarities in loading and behavior. The compact/noncompact limit, λ_p , for webs in flexure was established conservatively as $3.00\sqrt{E_s / F_y}$. The noncompact/slender limit, λ_r , for the web was established conservatively as $5.70\sqrt{E_s / F_y}$, which is also the maximum permitted for hollow structural sections. This was also established as the maximum permitted value due to the lack of experimental data and concrete placement concerns for thinner filled HSS cross sections (Varma and Zhang, 2009).

For round filled sections in axial compression, the noncompact/slender limit, λ_r , was established as $0.19E/F_y$, which is 1.73 times the limit ($0.11E/F_y$) for hollow round sections. This was based on the findings of Bradford et al. (2002) mentioned earlier, and it compares well with experimental data. The maximum permitted D/t equal to $0.31E/F_y$ is based on the lack of experimental data and the potential effects of concrete placement in extremely slender filled HSS cross sections. For round filled sections in flexure, the compact/noncompact limit, λ_p , in Table I1.1b was developed conservatively as 1.25 times the limit ($0.07E/F_y$) for round hollow structural sections. The noncompact/slender limit, λ_r , was assumed conservatively to be the same for round hollow structural sections ($0.31E/F_y$). This was also established as the maximum permitted value due to lack of experimental data and concrete placement concerns for thinner filled HSS cross sections (Varma and Zhang, 2009).

I2. AXIAL FORCE

In Section I2, the design of concrete-encased and concrete-filled composite members is treated separately, although they have much in common. The intent is to facilitate design by keeping the general principles and detailing requirements for each type of compression member separate.

An ultimate strength cross section model is used to determine the section strength (Leon et al., 2007; Leon and Hajjar, 2008). This model is similar to that used in previous LRFD Specifications. The major difference is that the full strength of the reinforcing steel and concrete are accounted for rather than the 70% that was used in those previous Specifications. In addition, these provisions give the strength of the

composite section as a force, while the previous approach had converted that force to an equivalent stress. Since the reinforcing steel and concrete had been arbitrarily discounted, the previous provisions did not accurately predict strength for compression members with a low percentage of steel.

The design for length effects is consistent with that for steel compression members. The equations used are the same as those in Chapter E, albeit in a different format, and as the percent of concrete in the section decreases, the design defaults to that of a steel section (although with different resistance and safety factors). Comparisons between the provisions in the Specification and experimental data show that the method is generally conservative but that the coefficient of variation obtained is large (Leon et al., 2007).

1. Encased Composite Members

1a. Limitations

- (1) In this Specification, the use of composite compression members is applicable to a minimum steel ratio (area of steel shape divided by the gross area of the member) equal to or greater than 1%.
- (2) The specified minimum quantity for transverse reinforcement is intended to provide good confinement to the concrete. It is the intent of the Specification that the transverse tie provisions of ACI 318 Chapter 7 be followed in addition to the limits provided.
- (3) A minimum amount of longitudinal reinforcing steel is prescribed to ensure that unreinforced concrete encasements are not designed with these provisions. Continuous longitudinal bars should be placed at each corner of the cross section. Additional provisions for minimum number of longitudinal bars are provided in ACI 318 Section 10.9.2. Other longitudinal bars may be needed to provide the required restraint to the cross-ties, but that longitudinal steel cannot be counted towards the minimum area of longitudinal reinforcing nor the cross-sectional strength unless it is continuous and properly anchored.

1b. Compressive Strength

The compressive strength of the cross section is given as the sum of the ultimate strengths of the components. The strength is not capped as in reinforced concrete compression member design for a combination of the following reasons: (1) the resistance factor is 0.75 (lower than some older Specifications); (2) the required transverse steel provides better performance than a typical reinforced concrete compression member; (3) the presence of a steel section near the center of the section reduces the possibility of a sudden failure due to buckling of the longitudinal reinforcing steel; and (4) there will typically be moment present due to the manner in which stability is addressed in the Specification through the use of a minimum notional load and the size of the member and the typical force introduction mechanisms.

For application of encased composite members using the direct analysis method as defined in Chapter C, and pending the results of ongoing research on composite compression members, it is suggested that the reduced flexural stiffness EI^* be based on

the use of the $0.8\tau_b$ reduction applied to the EI_{eff} (from Equation I2-6) unless a more comprehensive study is undertaken. Alternatively, designers are referred to ACI 318 Chapter 10 for appropriate E_cI_g values to use with the $0.8\tau_b$ stiffness reduction in performing frame analysis using encased composite compression members whose stiffness may be evaluated in a similar way to conventional reinforced concrete compression members. Refer to Commentary Section I3.2 for recommendations on appropriate stiffness for composite beams.

1c. Tensile Strength

Section I2.1c clarifies the tensile strength to be used in situations where uplift is a concern and for computations related to beam-column interaction. The provision focuses on the limit state of yield on gross area. Where appropriate for the structural configuration, consideration should also be given to other tensile strength and connection strength limit states as specified in Chapters D and J.

2. Filled Composite Members

2a. Limitations

- (1) As discussed for encased compression members, it is permissible to design filled composite compression members with a steel ratio as low as 1%.
- (2) Filled composite sections are classified as compact, noncompact or slender depending on the tube slenderness, b/t or D/t , and the limits in Table I1.1a.

2b. Compressive Strength

A compact hollow structural section (HSS) has sufficient thickness to develop yielding of the steel HSS in longitudinal compression, and to provide confinement to the concrete infill to develop its compressive strength (0.85 or $0.95f'_c$). A noncompact section has sufficient tube thickness to develop yielding of the steel tube in the longitudinal direction, but it cannot adequately confine the concrete infill after it reaches $0.70f'_c$ compressive stress in the concrete and starts undergoing significant inelasticity and volumetric dilation, thus pushing against the steel HSS. A slender section can neither develop yielding of the steel HSS in the longitudinal direction, nor confine the concrete after it reaches $0.70f'_c$ compressive stress in the concrete and starts undergoing inelastic strains and significant volumetric dilation pushing against the HSS (Varma and Zhang, 2009).

Figure C-I2.1 shows the variation of the nominal axial compressive strength, P_{no} , of the composite section with respect to the HSS slenderness. As shown, compact sections can develop the full plastic strength, P_p , in compression. The nominal axial strength, P_{no} , of noncompact sections can be determined using a quadratic interpolation between the plastic strength, P_p , and the yield strength, P_y , with respect to the tube slenderness. This interpolation is quadratic because the ability of the steel tube to confine the concrete infill undergoing inelasticity and volumetric dilation decreases rapidly with HSS slenderness. Slender sections are limited to developing the critical buckling stress, F_{cr} , of the steel HSS and $0.70f'_c$ of the concrete infill (Varma and Zhang, 2009).

The nominal axial strength, P_n , of composite compression members including length effects may be determined using Equations I2-2 and I2-3, while using EI_{eff} (from Equation I2-12) to account for composite section rigidity and P_{no} to account for the effects of local buckling as described above. This approach is slightly different than the one used for hollow structural sections found in Section E7, where the effective local buckling stress, f , for slender sections has an influence on the column buckling stress, F_{cr} , and vice versa. This approach was not implemented for filled compression members because: (i) their axial strength is governed significantly by the contribution of the concrete infill, (ii) concrete inelasticity occurs within the compression member failure segment irrespective of the buckling load, and (iii) the calculated nominal strengths compare conservatively with experimental results (Varma and Zhang, 2009).

For application of filled composite members in the direct analysis method as defined in Chapter C and pending the results of ongoing research on composite compression members, it is suggested that the reduced flexural stiffness, EI^* , be based on the use of the $0.8\tau_b$ reduction applied to the EI_{eff} from Equation I2-12 unless a more comprehensive study is undertaken.

2c. Tensile Strength

As for encased compression members, Section I2.2c specifies the tensile strength for filled composite members. Similarly, while the provision focuses on the limit state of yield on gross area, where appropriate, consideration should also be given to other tensile strength and connection strength limit states as specified in Chapters D and J.

I3. FLEXURE

1. General

Three types of composite flexural members are addressed in this section: fully encased steel beams, concrete-filled HSS, and steel beams with mechanical anchorage to a concrete slab which are generally referred to as composite beams.

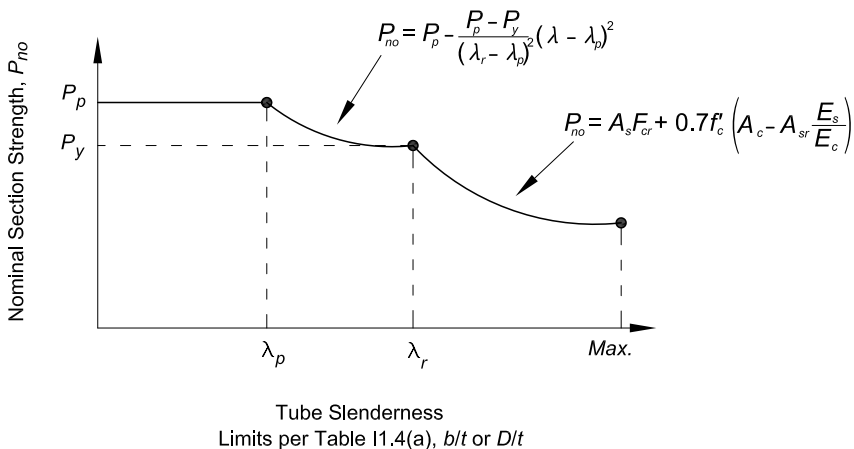

Fig. C-I2.1. Nominal axial strength, P_{no} , vs. HSS slenderness.

1a. Effective Width

The same effective width rules apply to composite beams with a slab on either one side or both sides of the beam. In cases where the *effective stiffness* of a beam with a one-sided slab is important, special care should be exercised since this model can substantially overestimate stiffness (Brosnan and Uang, 1995). To simplify design, the effective width is based on the full span, center-to-center of supports, for both simple and continuous beams.

1b. Strength During Construction

Composite beam design requires care in considering the loading history. Loads applied to an unshored beam before the concrete has cured are resisted by the steel section alone; total loads applied before and after the concrete has cured are considered to be resisted by the composite section. It is usually assumed for design purposes that concrete has hardened when it attains 75% of its design strength. Unshored beam deflection caused by fresh concrete tends to increase slab thickness and dead load. For longer spans this may lead to instability analogous to roof ponding. Excessive increase of slab thickness may be avoided by beam camber. Pouring the slab to a constant thickness will also help eliminate the possibility of ponding instability (Ruddy, 1986). When forms are not attached to the top flange, lateral bracing of the steel beam during construction may not be continuous and the unbraced length may control flexural strength, as defined in Chapter F.

This Specification does not include special requirements for strength during construction. For these noncomposite beams, the provisions of Chapter F apply.

Load combinations for construction loads should be determined for individual projects according to local conditions, using ASCE (2010) as a guide.

2. Composite Beams with Steel Headed Stud or Steel Channel Anchors

Section I3.2 applies to simple and continuous composite beams with steel anchors, constructed with or without temporary shores.

When a composite beam is controlled by deflection, the design should limit the behavior of the beam to the elastic range under serviceability load combinations. Alternatively, the amplification effects of inelastic behavior should be considered when deflection is checked.

It is often not practical to make accurate stiffness calculations of composite flexural members. Comparisons to short-term deflection tests indicate that the *effective moment of inertia*, I_{eff} , is 15 to 30% lower than that calculated based on linear elastic theory, I_{equiv} . Therefore, for realistic deflection calculations, I_{eff} should be taken as $0.75I_{equiv}$ (Leon, 1990; Leon and Alsamsam, 1993).

As an alternative, one may use a lower bound moment of inertia, I_{LB} , as defined below:

$$I_{LB} = I_s + A_s(Y_{ENA} - d_3)^2 + (\Sigma Q_n / F_y)(2d_3 + d_1 - Y_{ENA})^2 \quad (C-I3-1)$$

where

$$\begin{aligned}
 A_s &= \text{area of steel cross section, in.}^2 \text{ (mm}^2\text{)} \\
 d_1 &= \text{distance from the compression force in the concrete to the top of the steel section, in. (mm)} \\
 d_3 &= \text{distance from the resultant steel tension force for full section tension yield to the top of the steel, in. (mm)} \\
 I_{LB} &= \text{lower bound moment of inertia, in.}^4 \text{ (mm}^4\text{)} \\
 I_s &= \text{moment of inertia for the structural steel section, in.}^4 \text{ (mm}^4\text{)} \\
 \Sigma Q_n &= \text{sum of the nominal strengths of steel anchors between the point of maximum positive moment and the point of zero moment to either side, kips (kN)} \\
 Y_{ENA} &= [A_s d_3 + (\Sigma Q_n / F_y) (2d_3 + d_1)] / [A_s + (\Sigma Q_n / F_y)], \text{ in. (mm)} \quad \text{(C-I3-2)}
 \end{aligned}$$

The use of constant stiffness in elastic analyses of continuous beams is analogous to the practice in reinforced concrete design. The stiffness calculated using a weighted average of moments of inertia in the positive moment region and negative moment regions may take the following form:

$$I_t = aI_{pos} + bI_{neg} \quad \text{(C-I3-3)}$$

where

$$\begin{aligned}
 I_{pos} &= \text{effective moment of inertia for positive moment, in.}^4 \text{ (mm}^4\text{)} \\
 I_{neg} &= \text{effective moment of inertia for negative moment, in.}^4 \text{ (mm}^4\text{)}
 \end{aligned}$$

The effective moment of inertia is based on the cracked transformed section considering the degree of composite action. For continuous beams subjected to gravity loads only, the value of a may be taken as 0.6 and the value of b may be taken as 0.4. For composite beams used as part of a lateral force resisting system in moment frames, the value of a and b may be taken as 0.5 for calculations related to drift.

In cases where elastic behavior is desired, the cross-sectional strength of composite members is based on the superposition of elastic stresses including consideration of the effective section modulus at the time each increment of load is applied. For cases where elastic properties of partially composite beams are needed, the elastic moment of inertia may be approximated by

$$I_{equiv} = I_s + \sqrt{(\Sigma Q_n / C_f)} (I_{tr} - I_s) \quad \text{(C-I3-4)}$$

where

$$\begin{aligned}
 I_s &= \text{moment of inertia for the structural steel section, in.}^4 \text{ (mm}^4\text{)} \\
 I_{tr} &= \text{moment of inertia for the fully composite uncracked transformed section, in.}^4 \text{ (mm}^4\text{)} \\
 \Sigma Q_n &= \text{strength of steel anchors between the point of maximum positive moment and the point of zero moment to either side, kips (N)} \\
 C_f &= \text{compression force in concrete slab for fully composite beam; smaller of } A_s F_y \text{ and } 0.85 f'_c A_c, \text{ kips (N)} \\
 A_c &= \text{area of concrete slab within the effective width, in.}^2 \text{ (mm}^2\text{)}
 \end{aligned}$$

The effective section modulus, S_{eff} , referred to the tension flange of the steel section for a partially composite beam, may be approximated by

$$S_{eff} = S_s + \sqrt{(\Sigma Q_n / C_f)} (S_{tr} - S_s) \quad (C-I3-5)$$

where

S_s = section modulus for the structural steel section, referred to the tension flange, in.³ (mm³)

S_{tr} = section modulus for the fully composite uncracked transformed section, referred to the tension flange of the steel section, in.³ (mm³)

Equations C-I3-4 and C-I3-5 should not be used for ratios, $\Sigma Q_n / C_f$, less than 0.25. This restriction is to prevent excessive slip, as well as substantial loss in beam stiffness. Studies indicate that Equations C-I3-4 and C-I3-5 adequately reflect the reduction in beam stiffness and strength, respectively, when fewer anchors are used than required for full composite action (Grant et al., 1977).

U.S. practice does not generally require the following items to be considered. They are highlighted here for a designer who chooses to construct something for which these items might apply.

1. Horizontal shear strength of the slab: For the case of girders with decks with narrow troughs or thin slabs, shear strength of the slab may govern the design (for example, see Figure C-I3.1). Although the configuration of decks built in the U.S. tends to preclude this mode of failure, it is important that it be checked if the force in the slab is large or an unconventional assembly is chosen. The shear strength of the slab may be calculated as the superposition of the shear strength of the concrete plus the contribution of any slab steel crossing the shear plane. The required shear strength, as shown in the figure, is given by the difference in the force between the regions inside and outside the potential failure surface. Where experience has shown that longitudinal cracking detrimental to serviceability is likely to occur, the slab should be reinforced in the direction transverse to the supporting steel section. It is recommended that the area of such reinforcement be at least 0.002 times the concrete area in the longitudinal direction of the beam and that it be uniformly distributed.
2. Rotational capacity of hinging zones: There is no required rotational capacity for hinging zones. Where plastic redistribution to collapse is allowed, the moments

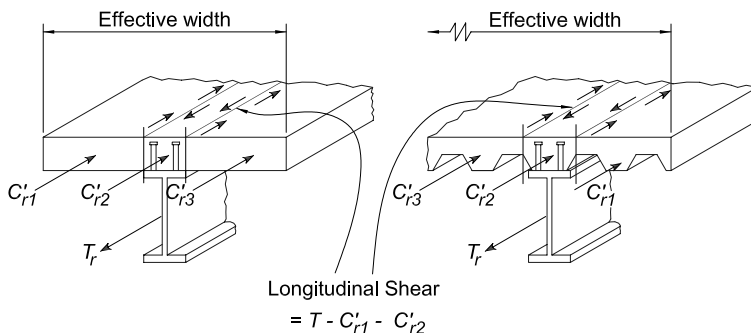

Fig. C-I3.1. Longitudinal shear in the slab [after Chien and Ritchie (1984)].

at a cross section may be as much as 30% lower than those given by a corresponding elastic analysis. This reduction in load effects is predicated, however, on the ability of the system to deform through very large rotations. To achieve these rotations, very strict local buckling and lateral-torsional buckling requirements must be fulfilled (Dekker et al., 1995). For cases in which a 10% redistribution is utilized, as permitted in Section B3.7, the required rotation capacity is within the limits provided by the local and lateral-torsional buckling provisions of Chapter F. Therefore, a rotational capacity check is not normally required for designs using this provision.

3. Minimum amount of shear connection: There is no minimum requirement for the amount of shear connection. Design aids in the U.S. often limit partial composite action to a minimum of 25% for practical reasons, but two issues arise with the use of low degrees of partial composite action. First, less than 50% composite action requires large rotations to reach the available flexural strength of the member and can result in very limited ductility after the nominal strength is reached. Second, low composite action results in an early departure from elastic behavior in both the beam and the studs. The current provisions, which are based on ultimate strength concepts, have eliminated checks for ensuring elastic behavior under service load combinations, and this can be an issue if low degrees of partial composite action are used.
4. Long-term deformations due to shrinkage and creep: There is no direct guidance in the computation of the long-term deformations of composite beams due to creep and shrinkage. The long-term deformation due to shrinkage can be calculated with the simplified model shown in Figure C-I3.2, in which the effect of shrinkage is taken as an equivalent set of end moments given by the shrinkage force (long-term restrained shrinkage strain times modulus of concrete times effective area of concrete) times the eccentricity between the center of the slab and the elastic neutral

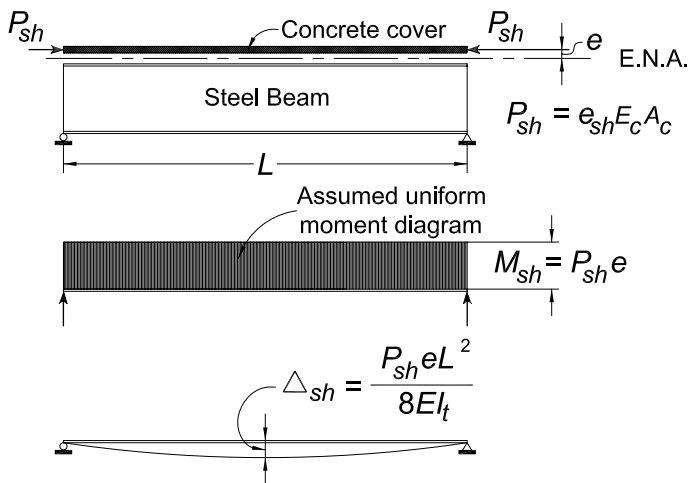

Fig. C-I3.2. Calculation of shrinkage effects [from Chien and Ritchie (1984)].

axis. If the restrained shrinkage coefficient for the aggregates is not known, the shrinkage strain for these calculations may be taken as 0.02%. The long-term deformations due to creep, which can be quantified using a model similar to that shown in the figure, are small unless the spans are long and the permanent live loads large. For shrinkage and creep effects, special attention should be given to lightweight aggregates, which tend to have higher creep coefficients and moisture absorption and lower modulus of elasticity than conventional aggregates, exacerbating any potential deflection problems. Engineering judgment is required, as calculations for long-term deformations require consideration of the many variables involved and because linear superposition of these effects is not strictly correct (ACI, 1997; Viest et al., 1997).

2a. Positive Flexural Strength

The flexural strength of a composite beam in the positive moment region may be controlled by the strength of the steel section, the concrete slab or the steel anchors. In addition, web buckling may limit flexural strength if the web is slender and a large portion of the web is in compression.

Plastic Stress Distribution for Positive Moment. When flexural strength is determined from the plastic stress distribution shown in Figure C-I3.3, the compression force, C , in the concrete slab is the smallest of:

$$C = A_{sw}F_y + 2A_{sf}F_y \quad (\text{C-I3-6})$$

$$C = 0.85f'_cA_c \quad (\text{C-I3-7})$$

$$C = \Sigma Q_n \quad (\text{C-I3-8})$$

where

f'_c = specified compressive strength of concrete, ksi (MPa)

A_c = area of concrete slab within effective width, in.² (mm²)

A_s = area of steel cross section, in.² (mm²)

A_{sw} = area of steel web, in.² (mm²)

A_{sf} = area of steel flange, in.² (mm²)

F_y = minimum specified yield stress of steel, ksi (MPa)

ΣQ_n = sum of nominal strengths of steel headed stud anchors between the point of maximum positive moment and the point of zero moment to either side, kips (N)

Longitudinal slab reinforcement makes a negligible contribution to the compression force, except when Equation C-I3-7 governs. In this case, the area of longitudinal reinforcement within the effective width of the concrete slab times the yield stress of the reinforcement may be added in determining C .

The depth of the compression block is

$$a = \frac{C}{0.85f'_cb} \quad (\text{C-I3-9})$$

where

b = effective width of concrete slab, in. (mm)

A fully composite beam corresponds to the case of C governed by the yield strength of the steel beam or the compressive strength of the concrete slab, as in Equation C-I3-6 or C-I3-7. The number and strength of steel headed stud anchors govern C for a partially composite beam as in Equation C-I3-8.

The plastic stress distribution may have the plastic neutral axis, PNA, in the web, in the top flange of the steel section, or in the slab, depending on the value of C .

The nominal plastic moment resistance of a composite section in positive bending is given by the following equation and Figure C-I3.3:

$$M_n = C(d_1 + d_2) + P_y(d_3 - d_2) \quad (\text{C-I3-10})$$

where

P_y = tensile strength of the steel section; $P_y = F_y A_s$, kips (N)

d_1 = distance from the centroid of the compression force, C , in the concrete to the top of the steel section, in. (mm)

d_2 = distance from the centroid of the compression force in the steel section to the top of the steel section, in. (mm). For the case of no compression in the steel section, $d_2 = 0$.

d_3 = distance from P_y to the top of the steel section, in. (mm)

Equation C-I3-10 is applicable for steel sections symmetrical about one or two axes.

According to Table B4.1b, local web buckling does not reduce the plastic strength of a bare steel beam if the beam depth-to-web thickness ratio is not larger than $3.76\sqrt{E/F_y}$. In the absence of web buckling research on composite beams, the same ratio is conservatively applied to composite beams.

For beams with more slender webs, this Specification conservatively adopts first yield as the flexural strength limit. In this case, stresses on the steel section from *permanent loads* applied to unshored beams before the concrete has cured must be superimposed on stresses on the composite section from loads applied to the beams

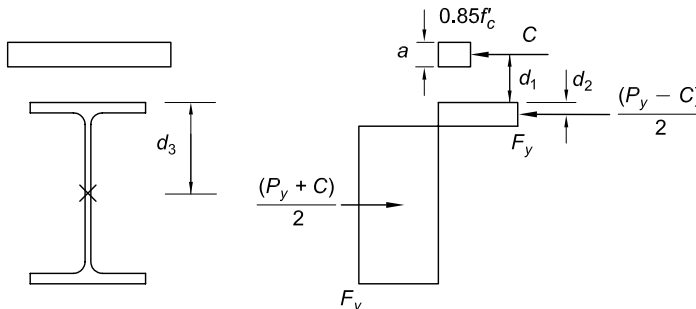

Fig. C-I3.3. Plastic stress distribution for positive moment in composite beams.

after hardening of concrete. For shored beams, all loads may be assumed to be resisted by the composite section.

When first yield is the flexural strength limit, the elastic transformed section is used to calculate stresses on the composite section. The modular ratio, $n = E_s/E_c$, used to determine the transformed section, depends on the specified unit weight and strength of concrete.

2b. Negative Flexural Strength

Plastic Stress Distribution for Negative Moment. When an adequately braced compact steel section and adequately developed longitudinal reinforcing bars act compositely in the negative moment region, the nominal flexural strength is determined from the plastic stress distributions as shown in Figure C-I3.4. Loads applied to a continuous composite beam with steel anchors throughout its length, after the slab is cracked in the negative moment region, are resisted in that region by the steel section and by properly anchored longitudinal slab reinforcement.

The tensile force, T , in the reinforcing bars is the smaller of:

$$T = F_{yr}A_r \quad (\text{C-I3-11})$$

$$T = \Sigma Q_n \quad (\text{C-I3-12})$$

where

A_r = area of properly developed slab reinforcement parallel to the steel beam and within the effective width of the slab, in.² (mm²)

F_{yr} = specified yield stress of the slab reinforcement, ksi (MPa)

ΣQ_n = sum of the nominal strengths of steel headed stud anchors between the point of maximum negative moment and the point of zero moment to either side, kips (N)

A third theoretical limit on T is the product of the area and yield stress of the steel section. However, this limit is redundant in view of practical limitations for slab reinforcement.

The nominal plastic moment resistance of a composite section in negative bending is given by the following equation:

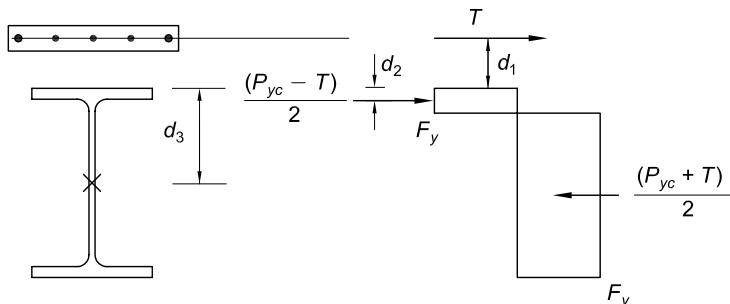

Fig. C-I3.4. Plastic stress distribution for negative moment.

$$M_n = T(d_1 + d_2) + P_{yc}(d_3 - d_2) \quad (\text{C-I3-13})$$

where

P_{yc} = the compressive strength of the steel section; $P_{yc} = A_s F_y$, kips (N)

d_1 = distance from the centroid of the longitudinal slab reinforcement to the top of the steel section, in. (mm)

d_2 = distance from the centroid of the tension force in the steel section to the top of the steel section, in. (mm)

d_3 = distance from P_{yc} to the top of the steel section, in. (mm)

2c. Composite Beams with Formed Steel Deck

Figure C-I3.5 is a graphic presentation of the terminology used in Section I3.2c.

The design rules for composite construction with formed steel deck are based upon a study (Grant et al., 1977) of the then-available test results. The limiting parameters listed in Section I3.2c were established to keep composite construction with formed steel deck within the available research data.

The Specification requires steel headed stud anchors to project a minimum of 1½ in. (38 mm) above the deck flutes. This is intended to be the minimum in-place projection, and stud lengths prior to installation should account for any shortening of the stud that could occur during the welding process. The minimum specified cover over a steel headed stud anchor of ½ in. (13 mm) after installation is intended to prevent the anchor from being exposed after construction is complete. In achieving this requirement the designer should carefully consider tolerances on steel beam camber, concrete placement and finishing tolerances, and the accuracy with which steel beam deflections can be calculated. In order to minimize the possibility of exposed anchors in the final construction, the designer should consider increasing the bare steel beam size to reduce or eliminate camber requirements (this also improves floor vibration performance), checking beam camber tolerances in the fabrication shop and monitoring concrete placement operations in the field. Wherever possible, the designer should also consider providing for anchor cover requirements above the ½ in. (13 mm) minimum by increasing the slab thickness while maintaining the 1½ in. (38 mm) requirement for anchor projection above the top of the steel deck as required by the Specification.

The maximum spacing of 18 in. (450 mm) for connecting composite decking to the support is intended to address a minimum uplift requirement during the construction phase prior to placing concrete.

2d. Load Transfer between Steel Beam and Concrete Slab

(1) Load Transfer for Positive Flexural strength

When studs are used on beams with formed steel deck, they may be welded directly through the deck or through prepunched or cut-in-place holes in the deck. The usual procedure is to install studs by welding directly through the deck; however, when the deck thickness is greater than 16 gage (1.5 mm) for single thickness, or 18 gage (1.2 mm) for each sheet of double thickness, or when the total thickness of galvanized coating is greater than 1.25 ounces/ft² (0.38

kg/m²), special precautions and procedures recommended by the stud manufacturer should be followed.

Composite beam tests in which the longitudinal spacing of steel anchors was varied according to the intensity of the static shear, and duplicate beams in which the anchors were uniformly spaced, exhibited approximately the same ultimate strength and approximately the same amount of deflection at nominal loads. Under distributed load conditions, only a slight deformation in the concrete near the more heavily stressed anchors is needed to redistribute the horizontal shear

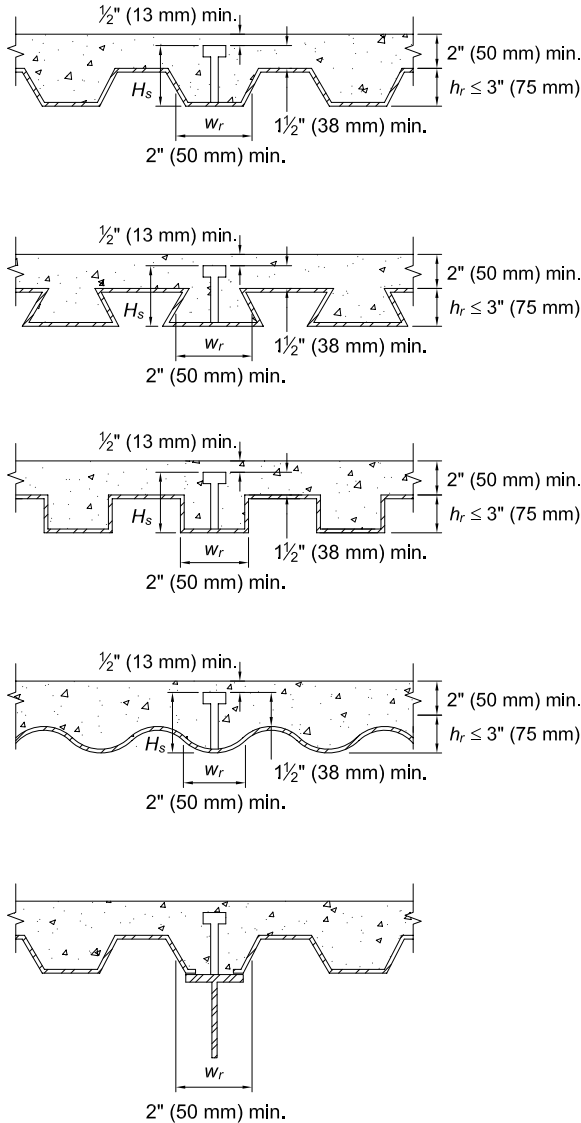

Fig. C-13.5. Steel deck limits.

to other less heavily stressed anchors. The important consideration is that the total number of anchors be sufficient to develop the shear on either side of the point of maximum moment. The provisions of this Specification are based upon this concept of composite action.

(2) Load Transfer for Negative Flexural strength

In computing the available flexural strength at points of maximum negative bending, reinforcement parallel to the steel beam within the effective width of the slab may be included, provided such reinforcement is properly anchored beyond the region of negative moment. However, steel anchors are required to transfer the ultimate tensile force in the reinforcement from the slab to the steel beam.

When steel deck includes units for carrying electrical wiring, crossover headers are commonly installed over the cellular deck perpendicular to the ribs. These create trenches that completely or partially replace sections of the concrete slab above the deck. These trenches, running parallel to or transverse to a composite beam, may reduce the effectiveness of the concrete flange. Without special provisions to replace the concrete displaced by the trench, the trench should be considered as a complete structural discontinuity in the concrete flange.

When trenches are parallel to the composite beam, the effective flange width should be determined from the known position of the trench.

Trenches oriented transverse to composite beams should, if possible, be located in areas of low bending moment and the full required number of studs should be placed between the trench and the point of maximum positive moment. Where the trench cannot be located in an area of low moment, the beam should be designed as noncomposite.

3. Encased Composite Members

Tests of concrete-encased beams demonstrate that: (1) the encasement drastically reduces the possibility of lateral-torsional instability and prevents local buckling of the encased steel; (2) the restrictions imposed on the encasement practically prevent bond failure prior to first yielding of the steel section; and (3) bond failure does not necessarily limit the moment strength of an encased steel beam (ASCE, 1979). Accordingly, this Specification permits three alternative design methods for determination of the nominal flexural strength: (a) based on the first yield in the tension flange of the composite section; (b) based on the plastic flexural strength of the steel section alone; and (c) based on the strength of the composite section obtained from the plastic stress distribution method or the strain-compatibility method. An assessment of the data indicates that the same resistance and safety factors may be used for all three approaches (Leon et al., 2007). For concrete-encased composite beams, method (c) is applicable only when shear anchors are provided along the steel section and reinforcement of the concrete encasement meets the specified detailing requirements. For concrete-encased composite beams, no limitations are placed on the slenderness of either the composite beam or the elements of the steel section, since the encasement effectively inhibits both local and lateral buckling.

In method (a), stresses on the steel section from permanent loads applied to unshored beams before the concrete has hardened must be superimposed on stresses on the

composite section from loads applied to the beams after hardening of the concrete. In this superposition, all permanent loads should be multiplied by the dead load factor and all live loads should be multiplied by the live load factor. For shored beams, all loads may be assumed as resisted by the composite section. Complete interaction (no slip) between the concrete and steel is assumed.

Insufficient research is available to warrant coverage of partially composite encased or filled sections subjected to flexure.

4. Filled Composite Members

Tests of concrete-filled composite beams indicate that: (1) the steel tube drastically reduces the possibility of lateral-torsional instability; (2) the concrete infill changes the buckling mode of the steel HSS; and (3) bond failure does not necessarily limit the moment strength of a filled composite beam (Leon et al., 2007).

Figure C-I3.6 shows the variation of the nominal flexural strength, M_n , of the filled section with respect to the HSS slenderness. As shown, compact sections can develop the full plastic strength, M_p , in flexure. The nominal flexural strength, M_n , of non-compact sections can be determined using a linear interpolation between the plastic strength, M_p , and the yield strength, M_y , with respect to the HSS slenderness. Slender sections are limited to developing the first yield moment, M_{cr} , of the composite section where the tension flange reaches first yielding, while the compression flange is limited to the critical buckling stress, F_{cr} , and the concrete is limited to linear elastic behavior with maximum compressive stress equal to $0.70f'_c$ (Varma and Zhang, 2009). The nominal flexural strengths calculated using the Specification compare conservatively with experimental results (Varma and Zhang, 2009). Figure C-I3.7

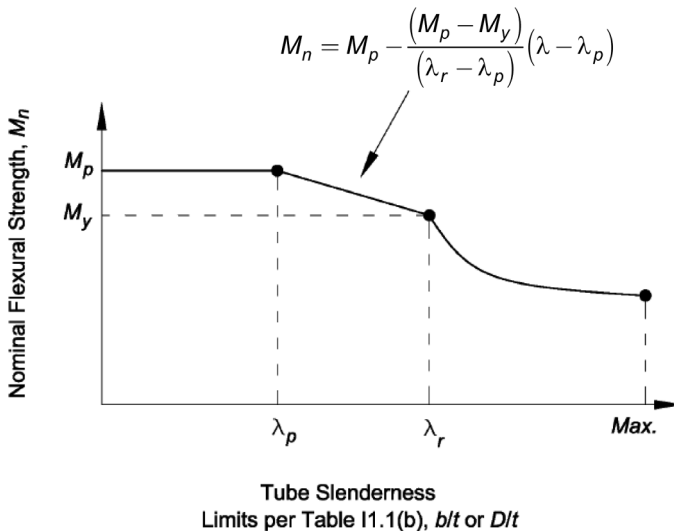
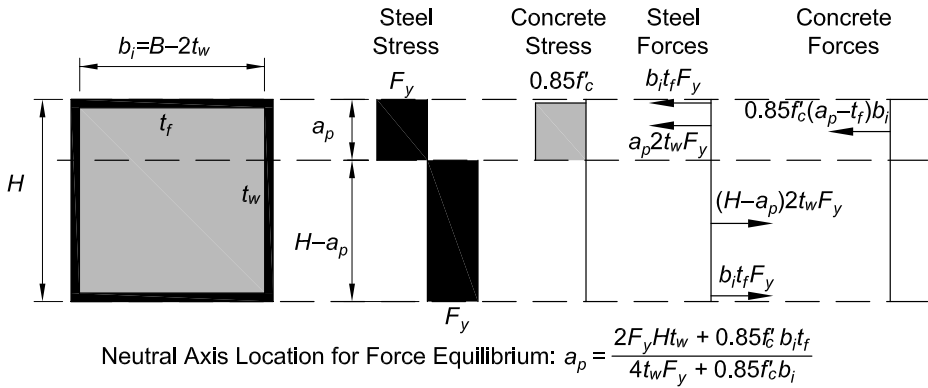
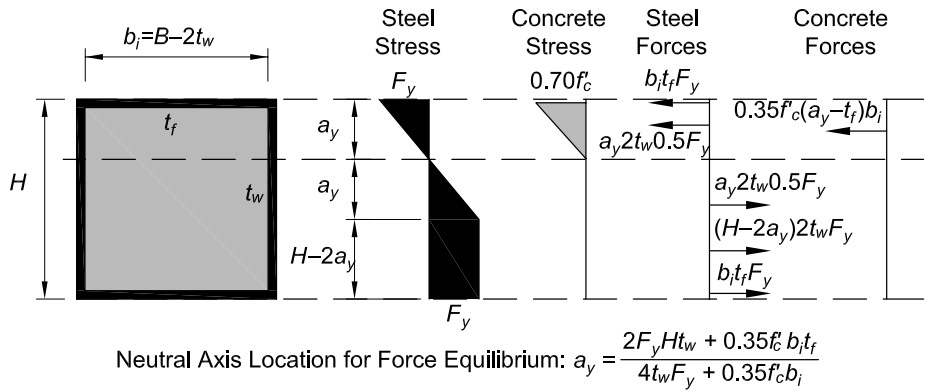

Fig. C-I3.6. Nominal flexural strength of filled beam vs. HSS slenderness.



(a) Compact section—stress blocks for calculating M_p



(b) Noncompact section—stress blocks for calculating M_y

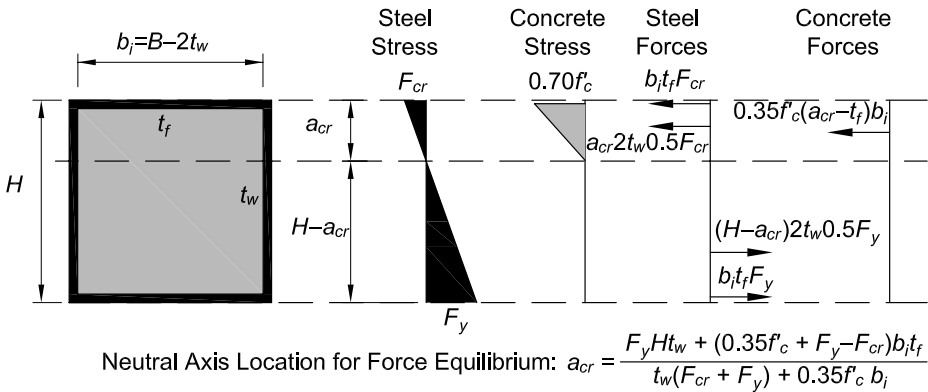

(c) Slender section—stress blocks for calculating first yield moment, M_{cr}

Fig. C-I3.7. Stress blocks for calculating nominal flexural strengths of filled rectangular box sections.

shows typical stress blocks for determining the nominal flexural strengths of compact, noncompact and slender filled rectangular box sections.

I4. SHEAR

Shear provisions for filled and encased composite members have been revised from the 2005 Specification, and all shear provisions are now consolidated in Section I4.

1. Filled and Encased Composite Members

Three methods for determining the shear strength of filled and encased composite members are now offered:

- (1) The available shear strength of the steel alone as specified in Chapter G. The intent of this method is to allow the designer to ignore the concrete contribution entirely and simply use the provisions of Chapter G with their associated resistance or safety factors.
- (2) The strength of the reinforced concrete portion (concrete plus transverse reinforcing bars) alone as defined by ACI 318. For this method, a resistance factor of 0.75 or the corresponding safety factor of 1.5 is to be applied which is consistent with ACI 318.
- (3) The strength of the steel section in combination with the contribution of the transverse reinforcing bars. For this method, the nominal shear strength (without a resistance or safety factor) of the steel section alone should be determined according to the provisions of Chapter G and then combined with the nominal shear strength of the transverse reinforcing as determined by ACI 318. These two nominal strengths should then be combined, and an overall resistance factor of 0.75 or the corresponding safety factor of 1.5 applied to the sum to determine the overall available shear strength of the member.

Though it would be logical to suggest provisions where both the contributions of the steel section and reinforced concrete are superimposed, there is insufficient research available to justify such a combination.

2. Composite Beams with Formed Steel Deck

A conservative approach to shear provisions for composite beams with steel headed stud or steel channel anchors is adopted by assigning all shear to the steel section in accordance with Chapter G. This method neglects any concrete contribution and serves to simplify design.

I5. COMBINED FLEXURE AND AXIAL FORCE

As with all frame analyses in this Specification, required strengths for composite beam-columns should be obtained from second-order analysis or amplified first-order analysis as specified in Chapter C and Appendix 7. Sections I2.1 and I2.2 suggest appropriate reduced stiffness, EI^* , for composite compression members to be used with the direct analysis method of Chapter C. For the assessment of the available strength, the Specification provisions for interaction between axial force and flexure in composite members are the same as for bare steel members as covered in

Section H1.1. The provisions also permit an analysis based on the strength provisions of Section I1.2 which would lead to an interaction diagram similar to those used in reinforced concrete design. This latter approach is discussed here.

For encased composite members, the available axial strength, including the effects of buckling, and the available flexural strength can be calculated using either the plastic stress distribution method or the strain-compatibility method (Leon et al., 2007; Leon and Hajjar, 2008). For filled composite members, the available axial and flexural strengths can be calculated using Sections I2.2 and I3.4, respectively, which also include the effects of local buckling for noncomposite and slender sections (classified according to Section I1.4).

The section below describes three different approaches to design composite beam-columns that are applicable to both concrete-encased steel shapes and to compact concrete-filled HSS sections. The first two approaches are based on variations in the plastic stress distribution method while the third method references AISC Design Guide 6, *Load and Resistance Factor Design of W-shapes Encased in Concrete* (Griffis, 1992), which is based on an earlier version of the Specification. The strain compatibility method is similar to that used in the design of concrete compression members as specified in ACI 318 Chapter 10. The design of noncompact and slender concrete-filled sections is limited to the use of method 1 described below (Varma and Zhang, 2009).

Method 1—Interaction Equations of Section H1. The first approach applies to doubly symmetric composite beam-columns, the most common geometry found in building construction. For this case, the interaction equations of Section H1 provide a conservative assessment of the available strength of the member for combined axial compression and flexure (see Figure C-I5.1). These provisions may also be used for

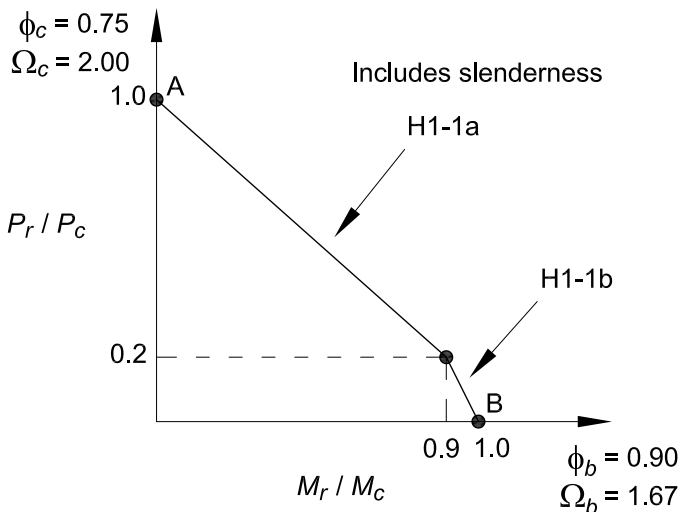

Fig. C-I5.1. Interaction diagram for composite beam-column design—Method 1.

combined axial tension and flexure. The degree of conservatism generally depends on the extent of concrete contribution to the overall strength relative to the steel contribution. The larger the load carrying contribution coming from the steel section the less conservative the strength prediction of the interaction equations from Section H1. Thus, for example, the equations are generally more conservative for members with high concrete compressive strength as compared to members with low concrete compressive strength. The advantages to this method include the following: (1) The same interaction equations used for steel beam-columns are applicable; and (2) Only two anchor points are needed to define the interaction curves—one for pure flexure (point B) and one for pure axial load (point A). Point A is determined using Equations I2-2 or I2-3, as applicable. Point B is determined as the flexural strength of the section according to the provisions of Section I3. Note that slenderness must also be considered using the provisions of Section I2. For many common concrete filled HSS sections, available axial strengths are provided in tables in the manual.

The design of noncompact and slender concrete-filled sections is limited to this method of interaction equation solution. The other two methods described below may not be used for their design, due to lack of research to validate those approaches for cross sections that are not compact. The nominal strengths predicted using the equations of Section H1 compare conservatively with a wide range of experimental data for noncompact/slender rectangular and round filled sections (Varma and Zhang, 2009).

Method 2—Interaction Curves from the Plastic Stress Distribution Method. The second approach applies to doubly symmetric composite beam-columns and is based on developing interaction surfaces for combined axial compression and flexure at the nominal strength level using the plastic stress distribution method. This approach results in interaction surfaces similar to those shown in Figure C-15.2. The four points identified in Figure C-15.2 are defined by the plastic stress distribution used

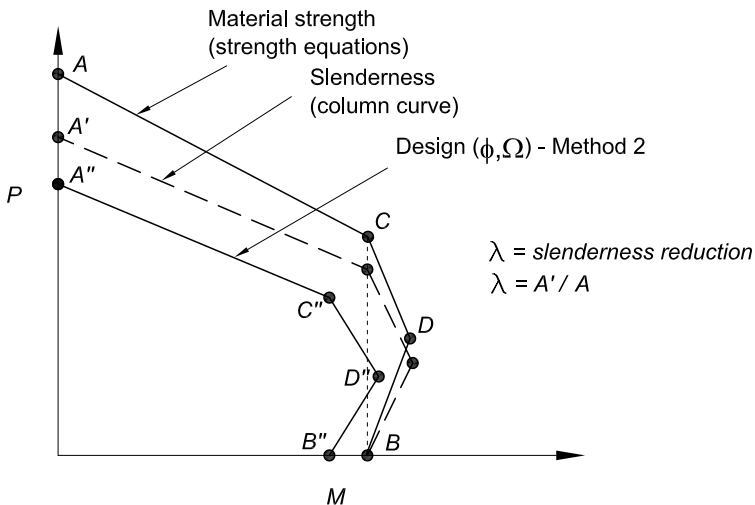

Fig. C-15.2 Interaction diagram for composite beam-columns—Method 2.

in their determination. The strength equations for concrete encased W-shapes and concrete filled HSS shapes used to define each point A through D are provided in the *AISC Design Examples* available at www.aisc.org (Geschwindner, 2010b). Point A is the pure axial strength determined according to Section I2. Point B is determined as the flexural strength of the section according to the provisions of Section I3. Point C corresponds to a plastic neutral axis location that results in the same flexural strength as Point B, but including axial compression. Point D corresponds to an axial compressive strength of one half of that determined for Point C. An additional Point E (see Figure C-II.1) is included (between points A and C) for encased W-shapes bent about their weak axis. Point E is an arbitrary point, generally corresponding to a plastic neutral axis location at the flange tips of the encased W-shape, necessary to better reflect bending strength for weak-axis bending of encased shapes. Linear interpolation between these anchor points may be used. However, with this approach, care should be taken in reducing Point D by a resistance factor or to account for member slenderness, as this may lead to an unsafe situation whereby additional flexural strength is permitted at a lower axial compressive strength than predicted by the cross section strength of the member. This potential problem may be avoided through a simplification to this method whereby point D is removed from the interaction surface. Figure C-I5.3 demonstrates this simplification with the vertical dashed line that connects point C'' to point B''. Once the nominal strength interaction surface is determined, length effects according to Equations I2-2 and I2-3 must be applied. Note that the same slenderness reduction factor ($\lambda = A'/A$ in Figure C-I5.2, equal to P_n/P_{no} , where P_n and P_{no} are calculated from Section I2) applies to points A, C, D and E. The available strength is then determined by applying the compression and bending resistance factors or safety factors.

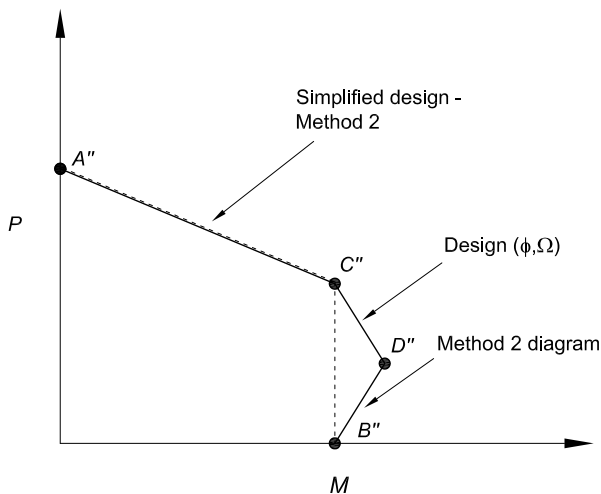

Fig. C-I5.3 Interaction diagram for composite beam-columns—Method 2 simplified.

Using linear interpolation between points A'', C'' and B'' in Figure C-15.3, the following interaction equations may be derived for composite beam-columns subjected to combined axial compression plus biaxial flexure:

(a) If $P_r < P_C$

$$\frac{M_{rx}}{M_{Cx}} + \frac{M_{ry}}{M_{Cy}} \leq 1 \quad (\text{C-15-1a})$$

(b) If $P_r \geq P_C$

$$\frac{P_r - P_C}{P_A - P_C} + \frac{M_{rx}}{M_{Cx}} + \frac{M_{ry}}{M_{Cy}} \leq 1 \quad (\text{C-15-1b})$$

where

P_r = required compressive strength, kips (N)

P_A = available axial compressive strength at Point A'', kips (N)

P_C = available axial compressive strength at Point C'', kips (N)

M_r = required flexural strength, kip-in. (N-mm)

M_C = available flexural strength at Point C'', kip-in. (N-mm)

x = subscript relating symbol to strong axis bending

y = subscript relating symbol to weak axis bending

For design according to Section B3.3 (LRFD):

$P_r = P_u$ = required compressive strength using LRFD load combinations, kips (N)

P_A = design axial compressive strength at Point A'' in Figure C-15.3, determined in accordance with Section I2, kips (N)

P_C = design axial compressive strength at Point C'', kips (N)

M_r = required flexural strength using LRFD load combinations, kip-in. (N-mm)

M_C = design flexural strength at Point C'', determined in accordance with Section I3, kip-in. (N-mm)

For design according to Section B3.4 (ASD):

$P_r = P_a$ = required compressive strength using ASD load combinations, kips (N)

P_A = allowable compressive strength at Point A'' in Figure C-15.3, determined in accordance with Section I2, kips (N)

P_C = allowable axial compressive strength at Point C'', kips (N)

M_r = required flexural strength using ASD load combinations, kip-in. (N-mm)

M_C = allowable flexural strength at Point C'', determined in accordance with Section I3, kip-in. (N-mm)

For *biaxial bending*, the value of the axial compressive strength at Point C may be different when computed for the major and minor axis. The smaller of the two values should be used in Equation C-15-1b and for the limits in Equations C-15-1a and b.

Method 3—Design Guide 6. The approach presented in AISC Design Guide 6, *Load and Resistance Factor Design of W-Shapes Encased in Concrete* (Griffis, 1992) may

also be used to determine the beam-column strength of concrete encased W-shapes. Although this method is based on an earlier version of the Specification, axial load and moment strengths can conservatively be determined directly from the tables in this design guide. The difference in resistance factors from the earlier Specification may safely be ignored.

16. LOAD TRANSFER

1. General Requirements

External forces are typically applied to composite members through direct connection to the steel member, bearing on the concrete, or a combination thereof. Design of the connection for force application shall follow the applicable limit states within Chapters J and K of the Specification as well as the provisions of Section I6. Note that for concrete bearing checks on filled composite members, confinement can affect the bearing strength for external force application as discussed in Commentary Section I6.2.

Once a load path has been provided for the introduction of external force to the member, the interface between the concrete and steel must be designed to transfer the longitudinal shear required to obtain force equilibrium within the composite section. Section I6.2 contains provisions for determining the magnitude of longitudinal shear to be transferred between the steel and concrete depending upon the external force application condition. Section I6.3 contains provisions addressing mechanisms for the transfer of longitudinal shear.

The load transfer provisions of the Specification are primarily intended for the transfer of longitudinal shear due to applied axial forces. Load transfer of longitudinal shear due to applied bending moments is beyond the scope of the Specification; however, tests (Lu and Kennedy, 1994; Prion and Boehme, 1994; Wheeler and Bridge, 2006) indicate that filled composite members can develop their full plastic moment capacity based on bond alone without the use of additional anchorage.

2. Force Allocation

The Specification addresses conditions in which the entire external force is applied to the steel or concrete as well as conditions in which the external force is applied to both materials concurrently. The provisions are based upon the assumption that in order to achieve equilibrium across the cross section, transfer of longitudinal shears along the interface between the concrete and steel shall occur such that the resulting force levels within the two materials may be proportioned according to a plastic stress distribution model. Load allocation based on the plastic stress distribution model is represented by Equations I6-1 and I6-2. Equation I6-1 represents the magnitude of force that is present within the concrete encasement or concrete fill at equilibrium. The longitudinal shear generated by loads applied directly to the steel section is determined based on the amount of force to be distributed to the concrete according to Equation I6-1. Conversely, when load is applied to the concrete section only, the longitudinal shear required for cross-sectional equilibrium is based upon the amount of force to be distributed to the steel according to Equation I6-2. Where loads

are applied concurrently to the two materials, the longitudinal shear force to be transferred to achieve cross-sectional equilibrium can be taken as either the difference in magnitudes between the portion of external force applied directly to the concrete and that required by Equation I6-1 or the portion of external force applied directly to the steel section and that required by Equation I6-2.

When external forces are applied to the concrete of a filled composite member via bearing, it is acceptable to assume that adequate confinement is provided by the steel encasement to allow the maximum available bearing strength permitted by Equation J8-2 to be used. This strength is obtained by setting the term $\sqrt{A_2 / A_1} = 2$. This discussion is in reference to the introduction of external load to the compression member. The transfer of longitudinal shear within the compression member via bearing mechanisms such as internal steel plates is addressed directly in Section I6.3a.

3. Force Transfer Mechanisms

Transfer of longitudinal shear by direct bearing via internal bearing mechanisms (such as internal bearing plates) or shear connection via steel anchors is permitted for both filled and encased composite members. Transfer of longitudinal shear via direct bond interaction is permitted solely for filled composite members. Although it is recognized that force transfer also occurs by direct bond interaction between the steel and concrete for encased composite columns, this mechanism is typically ignored and shear transfer is generally carried out solely with steel anchors (Griffis, 1992).

The use of the force transfer mechanism providing the largest resistance is permissible. Superposition of force transfer mechanisms is not permitted as the experimental data indicate that direct bearing or shear connection often does not initiate until after direct bond interaction has been breached, and little experimental data is available regarding the interaction of direct bearing and shear connection via steel anchors.

3a. Direct Bearing

For the general condition of assessing load applied directly to concrete in bearing, and considering a supporting concrete area that is wider on all sides than the loaded area, the nominal bearing strength for concrete may be taken as

$$R_n = 0.85 f'_c A_1 \sqrt{A_2 / A_1} \quad (\text{C-I6-1})$$

where

A_1 = loaded area of concrete, in.² (mm²)

A_2 = maximum area of the portion of the supporting surface that is geometrically similar to and concentric with the loaded area, in.² (mm²)

f'_c = specified compressive concrete strength, ksi (MPa)

The value of $\sqrt{A_2 / A_1}$ must be less than or equal to 2 (ACI, 2008).

For the specific condition of transferring longitudinal shear by direct bearing via internal bearing mechanisms, the Specification uses the maximum nominal bearing

strength allowed by Equation C-I6-1 of $1.7f_c'A_1$ as indicated in Equation I6-3. The resistance factor for bearing, ϕ_B , is 0.65 (and the associated safety factor, Ω_B , is 2.31) in accordance with ACI 318.

3b. Shear Connection

Steel anchors for shear connection shall be designed as composite components according to Section I8.3.

3c. Direct Bond Interaction

Force transfer by direct bond is commonly used in filled composite members as long as the connections are detailed to limit local deformations (API, 1993; Roeder et al., 1999). However, there is large scatter in the experimental data on the bond strength and associated force transfer length of filled composite compression members, particularly when comparing tests in which the concrete core is pushed through the steel tube (push-out tests) to tests in which a beam is connected just to the steel tube and beam shear is transferred to the filled composite compression member. The added eccentricities of the connection tests typically raise the bond strength of the filled composite compression members.

A reasonable lower bound value of the bond strength of filled composite compression members that meet the provisions of Section I2 is 60 psi (0.4 MPa). While push-out tests often show bond strengths below this value, eccentricity introduced into the connection is likely to increase the bond strength to this value or higher. Experiments also indicate that a reasonable assumption for the distance along the length of the filled composite compression member required to transfer the force from the steel HSS to the concrete core is approximately equal to twice the width of a rectangular HSS or the diameter of a round HSS, to either side of the point of load transfer.

The equations for direct bond interaction for filled composite compression members assume that one face of a rectangular filled composite compression member or one-quarter of the perimeter of a round filled composite compression member is engaged in the transfer of stress by direct bond interaction for the connection elements framing into the compression member from each side. If connecting elements frame in from multiple sides, the direct bond interaction strengths may be increased accordingly. The scatter in the data leads to the recommended low value of the resistance factor, ϕ , and the corresponding high value of the safety factor, Ω .

4. Detailing Requirements

To avoid overstressing the structural steel section or the concrete at connections in encased or filled composite members, transfer of longitudinal shear is required to occur within the load introduction length. The load introduction length is taken as two times the minimum transverse dimension of the composite member both above and below the load transfer region. The load transfer region is generally taken as the depth of the connecting element as indicated in Figure C-I6.1. In cases where the

applied forces are of such a magnitude that the required longitudinal shear transfer cannot take place within the prescribed load introduction length, the designer should treat the compression member as noncomposite along the additional length required for shear transfer.

For encased composite members, steel anchors are required throughout the compression member length in order to maintain composite action of the member under incidental moments (including flexure induced by incipient buckling). These anchors are typically placed at the maximum permitted spacing according to Section I8.3e. Additional anchors required for longitudinal shear transfer shall be located within the load introduction length as described previously.

Unlike concrete encased members, steel anchors in filled members are required only when used for longitudinal shear transfer and are not required along the length of the member outside of the introduction region. This discrepancy is due to the adequate confinement provided by the steel encasement which prevents the loss of composite action under incidental moments.

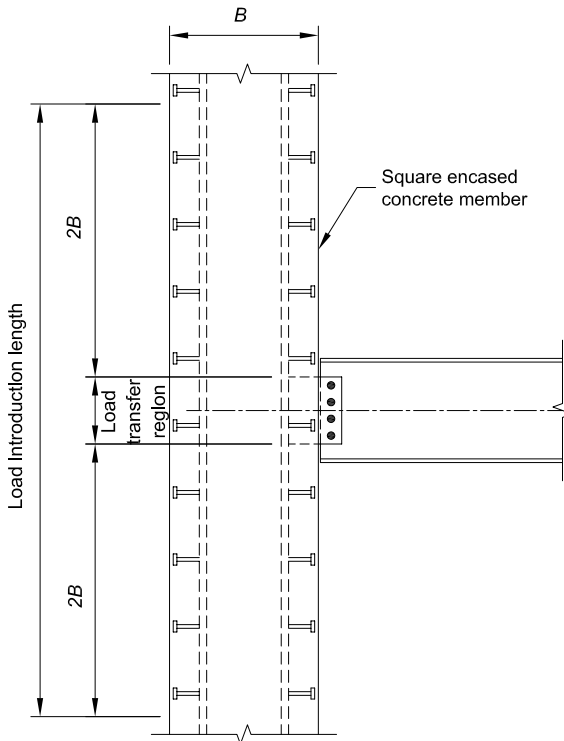

Fig. C-16.1. Load transfer region/load introduction length.

17. COMPOSITE DIAPHRAGMS AND COLLECTOR BEAMS

In composite construction, floor or roof slabs consisting of composite metal deck and concrete fill are typically connected to the structural framing to form composite diaphragms. Diaphragms are horizontally spanning members, analogous to deep beams, which distribute seismic and/or wind loads from their origin to the lateral-force-resisting-system either directly or in combination with load transfer elements known as collectors or collector beams (also known as diaphragm struts and drag struts).

Diaphragms serve the important structural function of interconnecting the components of a structure to behave as a unit. Diaphragms are commonly analyzed as simple-span or continuously spanning deep beams, and hence are subject to shear, moment and axial forces as well as the associated deformations. Further information on diaphragm classifications and behavior can be found in AISC (2006a) and SDI (2001).

Composite Diaphragm Strength

Diaphragms should be designed to resist all forces associated with the collection and distribution of seismic and/or wind forces to the lateral force resisting system. In some cases, loads from other floors should also be included, such as at a level where a horizontal offset in the lateral force resisting system exists. Several methods exist for determining the in-place shear strength of composite diaphragms. Three such methods are as follows:

- (1) As determined for the combined strength of composite deck and concrete fill including the considerations of composite deck configuration as well as type and layout of deck attachments. One publication which is considered to provide such guidance is the SDI *Diaphragm Design Manual* (SDI, 2004). This publication covers many aspects of diaphragm design including strength and stiffness calculations. Calculation procedures are also provided for alternative deck to framing connection methods such as puddle welding and mechanical fasteners in cases where anchors are not used. Where stud anchors are used, stud shear strength values shall be as determined in Section I8.
- (2) As the thickness of concrete over the steel deck is increased, the shear strength can approach that for a concrete slab of the same thickness. For example, in composite floor deck diaphragms having cover depths between 2 in. (50 mm) and 6 in. (150 mm), measured shear stresses in the order of $0.11\sqrt{f'_c}$ (where f'_c is in units of ksi) have been reported. In such cases, the diaphragm strength of concrete metal deck slabs can conservatively be based on the principles of reinforced concrete design (ACI, 2008) using the concrete and reinforcement above the metal deck ribs and ignoring the beneficial effect of the concrete in the flutes.
- (3) Results from in-plane tests of concrete filled diaphragms.

Collector Beams and Other Composite Elements

Horizontal diaphragm forces are transferred to the steel lateral load resisting frame as axial forces in collector beams (also known as diaphragm struts or drag struts). The design of collector beams has not been addressed directly in this Chapter. The rigorous design of composite beam-columns (collector beams) is complex and few

detailed guidelines exist on such members. Until additional research becomes available, a reasonable simplified design approach is provided as follows:

Force Application. Collector beams can be designed for the combined effects of axial load due to diaphragm forces as well as flexure due to gravity and/or lateral loads. The effect of the vertical offset (eccentricity) between the plane of the diaphragm and the centerline of the collector element should be investigated for design.

Axial Strength. The available axial strength of collector beams can be determined according to the noncomposite provisions of Chapter D and Chapter E. For compressive loading, collector beams are generally considered unbraced for buckling between braced points about their major axis, and fully braced by the composite diaphragm for buckling about the minor axis.

Flexural Strength. The available flexural strength of collector beams can be determined using either the composite provisions of Chapter I or the noncomposite provisions of Chapter F. It is recommended that all collector beams, even those designed as noncomposite members, contain enough anchors to ensure that a minimum of 25% composite action is achieved. This recommendation is intended to prevent designers from utilizing a small amount of anchors solely to transfer diaphragm forces on a beam designed as a noncomposite member. Anchors designed only to transfer horizontal shear due to lateral forces will still be subjected to horizontal shear due to flexure from gravity loads superimposed on the composite section and could become overloaded under gravity loading conditions. Overloading the anchors could result in loss of stud strength which could inhibit the ability of the collector beam to function as required for the transfer of diaphragm forces due to lateral loads.

Interaction. Combined axial force and flexure can be assessed using the interaction equations provided in Chapter H. As a reasonable simplification for design purposes, it is acceptable to use the noncomposite axial strength and the composite flexural strength in combination for determining interaction.

Shear Connection. It is not required to superimpose the horizontal shear due to lateral forces with the horizontal shear due to flexure for the determination of steel anchor requirements. The reasoning behind this methodology is twofold. First, the load combinations as presented in ASCE/SEI 7 (ASCE, 2010) provide reduced live load levels for load combinations containing lateral loads. This reduction decreases the demand on the steel anchors and provides additional capacity for diaphragm force transfer. Secondly, horizontal shear due to flexure flows in two directions. For a uniformly loaded beam, the shear flow emanates outwards from the center of the beam as illustrated in Figure C-I7.1(a). Lateral loads on collector beams induce shear in one direction. As these shears are superimposed, the horizontal shears on one portion of the beam are increased, and the horizontal shears on the opposite portion of the beam are decreased as illustrated in Figure C-I7.1(b). In lieu of additional research, it is considered acceptable for the localized additional loading of the steel anchors in the additive beam segment to be considered offset by the concurrent unloading of the steel anchors in the subtractive beam segment up to a force level corresponding to the summation of the nominal strengths of all studs placed on the beam.

18. STEEL ANCHORS

1. General

This section covers the strength, placement and limitations on the use of steel anchors in composite construction. A new definition is provided for “steel anchor” which replaces the old term “shear connector” in the 2005 and earlier Specifications. This change was made to recognize the more generic term “anchor” as used in ACI 318, PCI and throughout the industry. This term includes the traditional “shear connector,” now defined as a “steel headed stud anchor” and a “steel channel anchor” both of which have been part of previous Specifications. Both steel headed stud anchors and hot-rolled steel channel anchors are addressed in the Specification. The design provisions for steel anchors are given for composite beams with solid slabs or with formed steel deck and for composite components. A new glossary term is provided for “composite component” as a member, connecting element or assemblage in which steel and concrete elements work as a unit in the distribution of internal forces. This term excludes composite beams with solid slabs or formed steel deck. The provisions for composite components include the use of a resistance factor or safety factor applied to the nominal strength of the steel anchor, while for composite beams the resistance factor and safety factor are part of the composite beam resistance and safety factor.

Studs not located directly over the web of a beam tend to tear out of a thin flange before attaining full shear-resisting strength. To guard against this contingency,

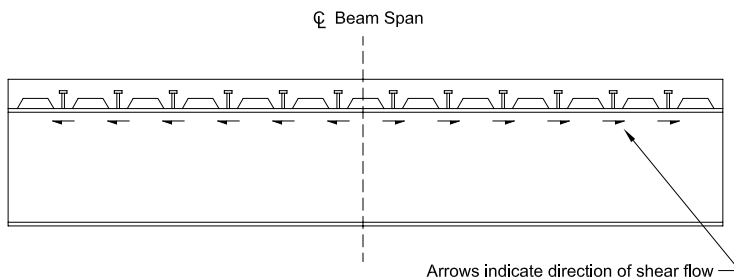

(a) Shear flow due to gravity loads only

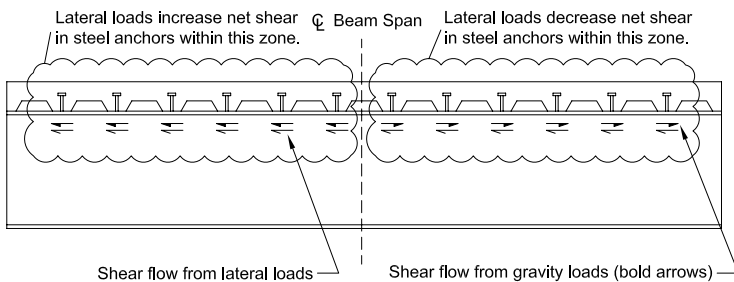

(b) Shear flow due to gravity and lateral loads in combination

Fig. C-17.1. Shear flow at collector beams.

the size of a stud not located over the beam web is limited to $2^{1/2}$ times the flange thickness (Goble, 1968). The practical application of this limitation is to select only beams with flanges thicker than the stud diameter divided by 2.5.

Section 18.2 requires a minimum ratio value of four for the overall headed stud anchor height to the shank diameter when calculating the nominal shear strength of a steel headed stud anchor in a composite beam. This requirement has been used in previous Specifications and has had a record of successful performance. For calculating the nominal shear strength of a steel headed stud anchor in other composite components, Section 18.3 increases this minimum ratio value to five for normal weight concrete and seven for lightweight concrete. Additional increases in the minimum value of this ratio are required for computing the nominal tensile strength or the nominal strength for interaction of shear and tension in Section 18.3. The provisions of Section 18.3 also establish minimum edge distances and center-to-center spacings for steel headed stud anchors if the nominal strength equations in that section are to be used. These limits are established in recognition of the fact that only steel failure modes are checked in the calculation of the nominal anchor strengths in Equations I8-3, I8-4 and I8-5. Concrete failure modes are not checked explicitly in these equations (Pallarés and Hajjar, 2010a, 2010b), whereas concrete failure is checked in Equation I8-1. This is discussed further in Commentary Section I8.3.

2. Steel Anchors in Composite Beams

2a. Strength of Steel Headed Stud Anchors

The present strength equations for composite beams and steel stud anchors are based on the considerable research that has been published in recent years (Jayas and Hosain, 1988a, 1988b; Mottram and Johnson, 1990; Easterling et al., 1993; Roddenberry et al., 2002a). Equation I8-1 contains R_g and R_p factors to bring these composite beam strength requirements comparable to other codes around the world. Other codes use a stud strength expression similar to the AISC Specification but the stud strength is reduced by a ϕ factor of 0.8 in the Canadian code (CSA, 2009) and by an even lower partial safety factor ($\phi = 0.60$) for the corresponding stud strength equations in *Eurocode 4* (CEN, 2003). The AISC Specification includes the stud anchor resistance factor as part of the overall composite beam resistance factor.

The majority of composite steel floor decks used today have a stiffening rib in the middle of each deck flute. Because of the stiffener, studs must be welded off-center in the deck rib. Studies have shown that steel studs behave differently depending upon their location within the deck rib (Lawson, 1992; Easterling et al., 1993; Van der Sanden, 1995; Yuan, 1996; Johnson and Yuan, 1998; Roddenberry et al., 2002a, 2002b). The so-called “weak” (unfavorable) and “strong” (favorable) positions are illustrated in Figure C-I8.1. Furthermore, the maximum value shown in these studies for studs welded through steel deck is on the order of 0.7 to $0.75F_uA_{sc}$. Studs placed in the weak position have strengths as low as $0.5F_uA_{sc}$.

The strength of stud anchors installed in the ribs of concrete slabs on formed steel deck with the ribs oriented perpendicular to the steel beam is reasonably estimated by the strength of stud anchors computed from Equation I8-1, which sets the default

value for steel stud strength equal to that for the weak stud position. Both AISC (1997a) and the Steel Deck Institute (SDI, 2001) recommend that studs be detailed in the strong position, but ensuring that studs are placed in the strong position is not necessarily an easy task because it is not always easy for the installer to determine where along the beam the particular rib is located relative to the end, midspan, or point of zero shear. Therefore, the installer may not be clear on which location is the strong, and which is the weak position.

In most composite floors designed today, the ultimate strength of the composite section is governed by the stud strength, as full composite action is typically not the most economical solution to resist the required strength. The degree of composite action, as represented by the ratio $\Sigma Q_n / F_y A_s$ (the total shear connection strength divided by the yield strength of the steel cross section), influences the flexural strength as shown in Figure C-18.2.

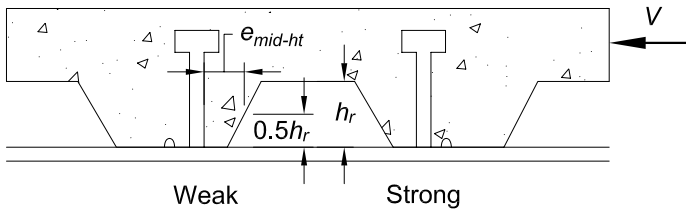

Fig. C-18.1. Weak and strong stud positions [Roddenberry et al. (2002b)].

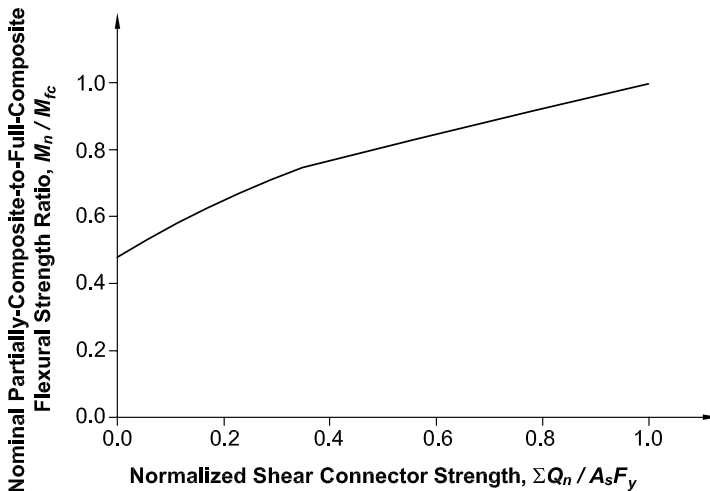

Fig. C-18.2. Normalized flexural strength versus shear connection strength ratio (W16×31, $F_y = 50$ ksi, $Y_2 = 4.5$ in.) (Easterling et al., 1993).

It can be seen from Figure C-I8.2 that a relatively large change in shear connection strength results in a much smaller change in flexural strength. Thus, formulating the influence of steel deck on shear anchor strength by conducting beam tests and back-calculating through the flexural model, as was done in the past, leads to an inaccurate assessment of stud strength when installed in metal deck.

The changes in stud anchor requirements that occurred in the 2005 Specification were not a result of either structural failures or performance problems. Designers concerned about the strength of existing structures based on earlier Specification requirements need to note that the slope of the curve shown in Figure C-I8.2 is rather flat as the degree of composite action approaches one. Thus, even a large change in steel stud strength does not result in a proportional decrease of the flexural strength. In addition, as noted above, the current expression does not account for all the possible shear force transfer mechanisms, primarily because many of them are difficult or impossible to quantify. However, as noted in Commentary Section I3.1, as the degree of composite action decreases, the deformation demands on steel studs increase. This effect is reflected by the increasing slope of the relationship shown in Figure C-I8.2 as the degree of composite action decreases. Thus designers should specify 50% composite action or more.

The reduction factor, R_p , for headed stud anchors used in composite beams with no decking has been reduced from 1.0 to 0.75 in the 2010 Specification. The methodology used for headed stud anchors that incorporates R_g and R_p was implemented in the 2005 Specification. The research (Roddenberry et al., 2002a) in which the factors (R_g and R_p) were developed focused almost exclusively on cases involving the use of headed stud anchors welded through steel deck. The research pointed to the likelihood that the solid slab case should use $R_p = 0.75$, however, the body of test data had not been established to support the change. More recent research has shown that the 0.75 factor is appropriate (Pallarés and Hajjar, 2010a).

2b. Strength of Steel Channel Anchors

Equation I8-2 is a modified form of the formula for the strength of channel anchors presented in Slutter and Driscoll (1965), which was based on the results of pushout tests and a few simply supported beam tests with solid slabs by Viest et al. (1952). The modification has extended its use to lightweight concrete.

Eccentricities need not be considered in the weld design for cases where the welds at the toe and heel of the channel are greater than $3/16$ in. (5 mm) and the anchor meets the following requirements:

$$1.0 \leq \frac{t_f}{t_w} \leq 5.5$$

$$\frac{H}{t_w} \geq 8.0$$

$$\frac{L_c}{t_f} \geq 6.0$$

$$0.5 \leq \frac{R}{t_w} \leq 1.6$$

where

t_f = flange thickness of channel anchor, in. (mm)

t_w = thickness of channel anchor web, in. (mm)

H = height of anchor, in. (mm)

L_c = length of anchor, in. (mm)

R = radius of the fillet between the flange and the web of the anchor, in. (mm)

2d. Detailing Requirements

Uniform spacing of shear anchors is permitted, except in the presence of heavy concentrated loads.

The minimum spacing of anchors along the length of the beam, in both flat soffit concrete slabs and in formed steel deck with ribs parallel to the beam, is six diameters; this spacing reflects development of shear planes in the concrete slab (Ollgaard et al., 1971). Because most test data are based on the minimum transverse spacing of four diameters, this transverse spacing was set as the minimum permitted. If the steel beam flange is narrow, this spacing requirement may be achieved by staggering the studs with a minimum transverse spacing of three diameters between the staggered row of studs. When deck ribs are parallel to the beam and the design requires more studs than can be placed in the rib, the deck may be split so that adequate spacing is available for stud installation. Figure C-I8.3 shows possible anchor arrangements.

3. Steel Anchors in Composite Components

This section applies to steel headed stud anchors used primarily in the load transfer (connection) region of composite compression members and beam-columns, concrete-encased and filled composite beams, composite coupling beams, and composite walls (see Figure C-I8.4), where the steel and concrete are working compositely within a member. In such cases, it is possible that the steel anchor will be subjected to shear, tension, or interaction of shear and tension. As the strength of the connectors in the load transfer region must be assessed directly (rather than implicitly within the strength assessment of a composite member), a resistance or safety factor should be applied, comparable to the design of bolted connections in Chapter J.

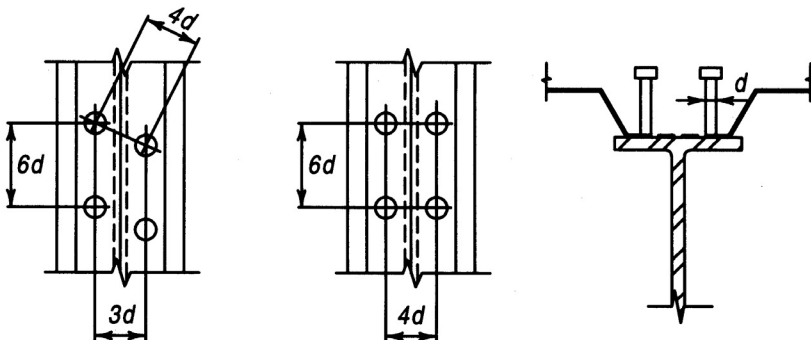

Fig. C-I8.3. Steel anchor arrangements.

These provisions are not intended for hybrid construction where the steel and concrete are not working compositely, such as with embed plates. Section I8.2 specifies the strength of steel anchors embedded in a solid concrete slab or in a concrete slab with formed steel deck in a composite beam.

Data from a wide range of experiments indicate that the failure of steel headed stud anchors subjected to shear occurs in the steel shank or weld in a large percentage of cases if the ratio of the overall height to the shank diameter of the steel headed stud anchor is greater than five for normal weight concrete. In the case of lightweight concrete, the necessary minimum ratio between the overall height of the stud and the diameter increases up to seven (Pallarés and Hajjar, 2010a). A similarly large percentage of failures occur in the steel shank or weld of steel headed stud anchors subjected to tension or interaction of shear and tension if the ratio of the overall height to shank diameter of the steel headed stud anchor is greater than eight for normal weight concrete. In the case of lightweight concrete, the necessary minimum ratio between the overall height of the stud and the diameter increases up to ten for steel headed stud anchors subjected to tension (Pallarés and Hajjar, 2010b). For steel headed stud anchors subjected to interaction of shear and tension in lightweight concrete, there are so few experiments available that it is not possible to discern sufficiently when the steel material will control the failure mode. For the strength of steel headed stud anchors in lightweight concrete subjected to interaction of shear and tension, it is recommended that the provisions of ACI 318 (ACI, 2008) Appendix D be used.

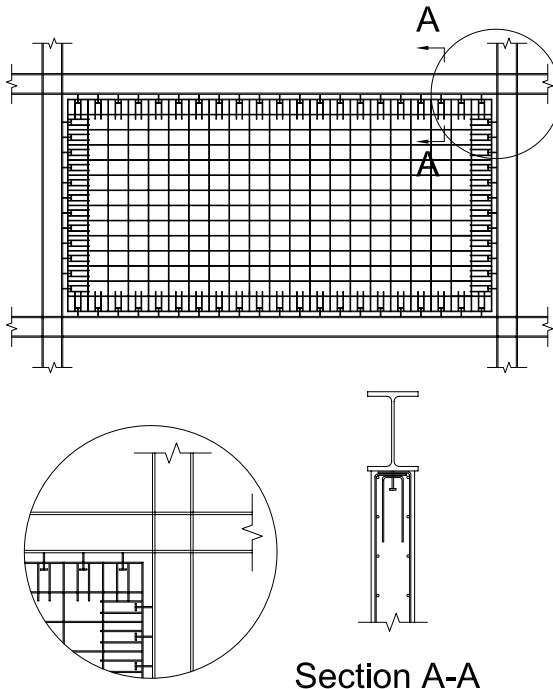

Fig. C-I8.4. Typical reinforcement detailing in a composite wall for steel headed stud anchors subjected to tension.

The use of edge distances in ACI 318 Appendix D to compute the strength of a steel anchor subjected to concrete crushing failure is complex. It is rare in composite construction that there is a nearby edge that is not uniformly supported in a way that prevents the possibility of concrete breakout failure due to a close edge. Thus, for brevity, the provisions in this Specification simplify the assessment of whether it is warranted to check for a concrete failure mode. Additionally, if an edge is supported uniformly, as would be common in composite construction, it is assumed that a concrete failure mode will not occur due to the edge condition. Thus, if these provisions are to be used, it is important that it be deemed by the engineer that a concrete breakout failure mode in shear is directly avoided through having the edges perpendicular to the line of force supported, and the edges parallel to the line of force sufficiently distant that concrete breakout through a side edge is not deemed viable. For loading in shear, the determination of whether breakout failure in the concrete is a viable failure mode for the stud anchor is left to the engineer. Alternatively, the provisions call for required anchor reinforcement with provisions comparable to those of ACI 318 Appendix D, Section D6.2.9 (which in turn refers to Chapter 12 of ACI 318) (ACI, 2008). In addition, the provisions of the applicable building code or ACI 318 Appendix D may be used directly to compute the strength of the steel headed stud anchor.

The steel limit states and resistance factors (and corresponding safety factors) covered in this section match with the corresponding limit states of ACI 318 Appendix D, although they were assessed independently for these provisions. As only steel limit states are required to be checked if there are no edge conditions, experiments that satisfy the minimum height/diameter ratio but that included failure of the steel headed stud anchor either in the steel or in the concrete were included in the assessment of the resistance and safety factors (Pallarés and Hajjar, 2010a, 2010b).

For steel headed stud anchors subjected to tension or combined shear and tension interaction, it is recommended that anchor reinforcement always be included around the stud to mitigate premature failure in the concrete. If the ratio of the diameter of the head of the stud to the shank diameter is too small, the provisions call for use of ACI 318 Appendix D to compute the strength of the steel headed stud anchor. If the distance to the edge of the concrete or the distance to the neighboring anchor is too small, the provisions call for required anchor reinforcement with provisions comparable to those of ACI 318 Appendix D, Section D5.2.9 (which in turn refers to Chapter 12 of ACI 318) (ACI, 2008). Alternatively, the provisions of the applicable building code or ACI 318 Appendix D may be also be used directly to compute the strength of the steel headed stud anchor.

19. SPECIAL CASES

Tests are required for composite construction that falls outside the limits given in this Specification. Different types of steel anchors may require different spacing and other detailing than steel headed stud and channel anchors.

CHAPTER J

DESIGN OF CONNECTIONS

The provisions of Chapter J cover the design of connections not subject to *cyclic loads*. Wind and other environmental loads are generally not considered to be cyclic loads. The provisions generally apply to connections other than HSS and box members. See Chapter K for HSS and box member connections and Appendix 3 for fatigue provisions.

J1. GENERAL PROVISIONS

1. Design Basis

In the absence of defined design loads, a minimum design load should be considered. Historically, a value of 10 kips (44 kN) for LRFD and 6 kips (27 kN) for ASD have been used as reasonable values. For smaller elements such as lacing, sag rods, girts or similar small members, a load more appropriate to the size and use of the part should be used. Both design requirements and construction loads should be considered when specifying minimum loads for connections.

2. Simple Connections

Simple connections are considered in Sections B3.6a and J1.2. In Section B3.6a, simple connections are defined (with further elaboration in Commentary Section B3.6) in an idealized manner for the purpose of analysis. The assumptions made in the analysis determine the outcome of the analysis that serves as the basis for design (for connections that means the force and deformation demands that the connection must resist). Section J1.2 focuses on the actual proportioning of the connection elements to achieve the required resistance. Thus, Section B3.6a establishes the modeling assumptions that determine the design forces and deformations for use in Section J1.2.

Sections B3.6a and J1.2 are not mutually exclusive. If a “simple” connection is assumed for analysis, the actual connection, as finally designed, must perform consistent with that assumption. A simple connection must be able to meet the required rotation and must not introduce strength and stiffness that significantly alter the rotational response.

3. Moment Connections

Two types of moment connections are defined in Section B3.6b: fully restrained (FR) and partially restrained (PR). FR moment connections must have sufficient strength and stiffness to transfer moment and maintain the angle between connected members. PR moment connections are designed to transfer moments but also allow rotation between connected members as the loads are resisted. The response characteristics of a PR connection must be documented in the technical literature or established by analytical or experimental means. The component elements of a PR

connection must have sufficient strength, stiffness and deformation capacity to satisfy the design assumptions.

4. Compression Members with Bearing Joints

The provisions for “compression members other than columns finished to bear” are intended to account for member out-of-straightness and also to provide a degree of robustness in the structure to resist unintended or accidental lateral loadings that may not have been considered explicitly in the design.

A provision analogous to that in Section J1.4(2)(i), requiring that splice materials and connectors have an available strength of at least 50% of the required compressive strength, has been in the AISC Specifications since 1946. The current Specification clarifies this requirement by stating that the force for proportioning the splice materials and connectors is a tensile force. This avoids uncertainty as to how to handle situations where compression on the connection imposes no force on the connectors.

Proportioning the splice materials and connectors for 50% of the required member strength is simple, but can be very conservative. In Section J1.4(2)(ii), the Specification offers an alternative that addresses directly the design intent of these provisions. The lateral load of 2% of the required compressive strength of the member simulates the effect of a kink at the splice, caused by an end finished slightly out-of-square or other construction condition. Proportioning the connection for the resulting moment and shear also provides a degree of robustness in the structure.

5. Splices in Heavy Sections

Solidified but still hot weld metal contracts significantly as it cools to ambient temperature. Shrinkage of large groove welds between elements that are not free to move so as to accommodate the shrinkage causes strains in the material adjacent to the weld that can exceed the yield point strain. In thick material the weld shrinkage is restrained in the thickness direction, as well as in the width and length directions, causing triaxial stresses to develop that may inhibit the ability to deform in a ductile manner. Under these conditions, the possibility of *brittle fracture* increases.

When splicing hot-rolled shapes with flange thickness exceeding 2 in. (50 mm) or heavy welded built-up members, these potentially harmful weld shrinkage strains can be avoided by using bolted splices, fillet-welded lap splices, or splices that combine a welded and bolted detail (see Figure C-J1.1). Details and techniques that perform well for materials of modest thickness usually must be changed or supplemented by more demanding requirements when welding thick material.

The provisions of AWS D1.1/D1.1M (AWS, 2010) are minimum requirements that apply to most structural welding situations. However, when designing and fabricating welded splices of hot-rolled shapes with flange thicknesses exceeding 2 in. (50 mm) and similar built-up cross sections, special consideration must be given to all aspects of the welded splice detail:

- (1) Notch-toughness requirements are required to be specified for tension members; see Commentary Section A3.

- (2) Generously sized weld access holes (see Section J1.6) are required to provide increased relief from concentrated weld shrinkage strains, to avoid close juncture of welds in orthogonal directions, and to provide adequate clearance for the exercise of high quality workmanship in hole preparation, welding, and for ease of inspection.
- (3) Preheating for thermal cutting is required to minimize the formation of a hard surface layer. (See Section M2.2.)
- (4) Grinding of copes and weld access holes to bright metal to remove the hard surface layer is required, along with inspection using magnetic particle or dye-penetrant methods, to verify that transitions are free of notches and cracks.

In addition to tension splices of truss chord members and tension flanges of flexural members, other joints fabricated from heavy sections subject to tension should be given special consideration during design and fabrication.

Alternative details that do not generate shrinkage strains can be used. In connections where the forces transferred approach the member strength, direct welded groove joints may still be the most effective choice.

Earlier editions of this Specification mandated that backing bars and weld tabs be removed from all splices of heavy sections. These requirements were deliberately removed, being judged unnecessary and, in some situations, potentially resulting in more harm than good. The Specification still permits the engineer of record to specify their removal when this is judged appropriate.

The previous requirement for the removal of backing bars necessitated, in some situations, that such operations be performed out-of-position; that is, the welding required to restore the backgouged area had to be applied in the overhead position. This may necessitate difficult equipment for gaining access, different welding equipment, processes and/or procedures, and other practical constraints. When box sections made of plate are spliced, access to the interior side (necessary for backing removal) is typically impossible.

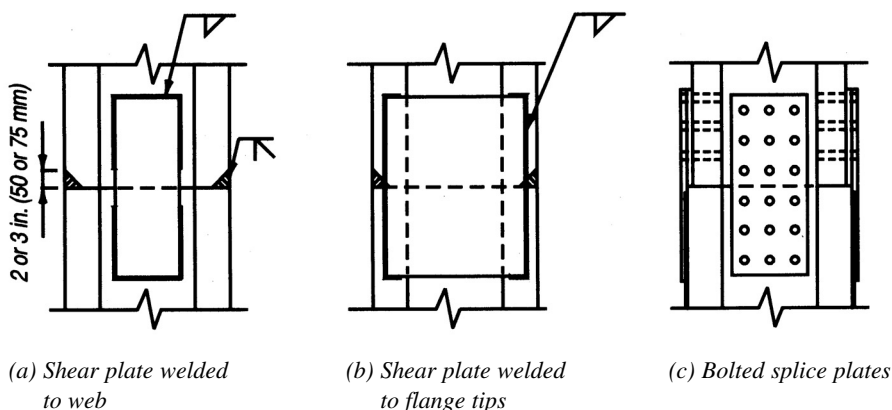

Fig. C-J1.1. Alternative splices that minimize weld restraint tensile stresses.

Weld tabs that are left in place on splices act as “short attachments” and attract little stress. Even though it is acknowledged that weld tabs might contain regions of inferior quality weld metal, the stress concentration effect is minimized since little stress is conducted through the attachment.

6. Weld Access Holes

Weld access holes are frequently required in the fabrication of structural components. The geometry of these structural details can affect the components’ performance. The size and shape of beam copes and weld access holes can have a significant effect on the ease of depositing sound weld metal, the ability to conduct nondestructive examinations, and the magnitude of the stresses at the geometric discontinuities produced by these details.

Weld access holes used to facilitate welding operations are required to have a minimum length from the toe of the weld preparation (see Figure C-J1.2) equal to 1.5 times the thickness of the material in which the hole is made. This minimum length

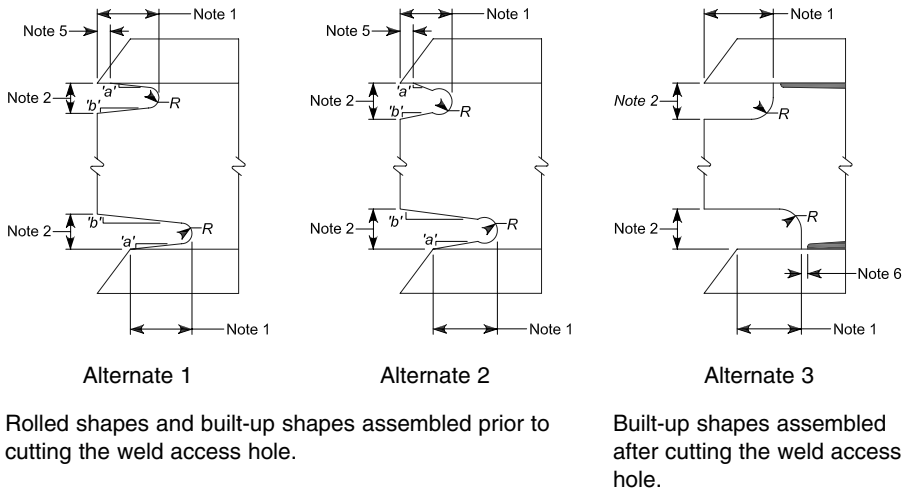

Notes: These are typical details for joints welded from one side against steel backing. Alternative details are discussed in the commentary text.

- 1) Length: Greater of $1.5t_w$ or $1\frac{1}{2}$ in. (38 mm)
- 2) Height: Greater of $1.0t_w$ or $\frac{3}{4}$ in. (19 mm) but need not exceed 2 in. (50 mm)
- 3) R : $\frac{3}{8}$ in. min. (10 mm). Grind the thermally cut surfaces of weld access holes in heavy shapes as defined in Sections A3.1(c) and (d).
- 4) Slope ‘a’ forms a transition from the web to the flange. Slope ‘b’ may be horizontal.
- 5) The bottom of the top flange is to be contoured to permit the tight fit of backing bars where they are to be used.
- 6) The web-to-flange weld of built-up members is to be held back a distance of at least the weld size from the edge of the access hole.

Fig. C-J1.2. Weld access hole geometry.

is expected to accommodate a significant amount of the weld shrinkage strains at the web-to-flange intersection.

The height of the weld access hole must provide sufficient clearance for ease of welding and inspection and must be large enough to allow the welder to deposit sound weld metal through and beyond the web. A weld access hole height equal to 1.0 times the thickness of the material with the access hole but not less than $\frac{3}{4}$ in. (19 mm) has been judged to satisfy these welding and inspection requirements. The height of the weld access hole need not exceed 2 in. (50 mm).

The geometry of the reentrant corner between the web and the flange determines the level of stress concentration at that location. A 90° reentrant corner having a very small radius produces a very high stress concentration that may lead to rupture of the flange. Consequently, to minimize the stress concentration at this location, the edge of the web is sloped or curved from the surface of the flange to the reentrant surface of the weld access hole.

Stress concentrations along the perimeter of weld access holes also can affect the performance of the joint. Consequently, weld access holes are required to be free of stress raisers such as notches and gouges.

Stress concentrations at web-to-flange intersections of built-up shapes can be decreased by terminating the weld away from the access hole. Thus, for built-up shapes with fillet welds or partial-joint-penetration groove welds that join the web to the flange, the weld access hole may terminate perpendicular to the flange, provided that the weld is terminated a distance equal to or greater than one weld size away from the access hole.

7. Placement of Welds and Bolts

Slight eccentricities between the gravity axis of single and double angle members and the center of gravity of connecting bolts or rivets have long been ignored as having negligible effect on the static strength of such members. Tests have shown

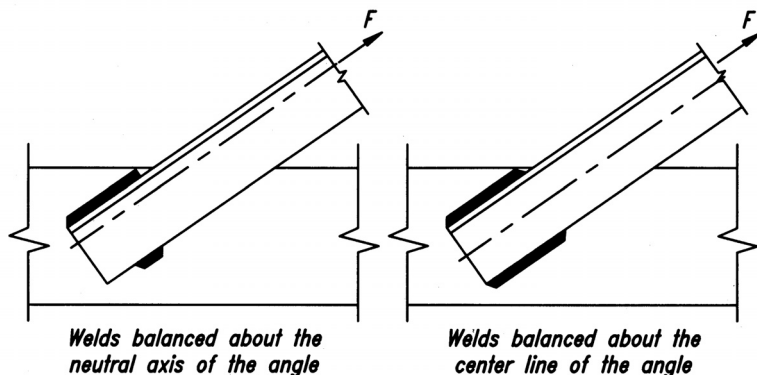

Fig. C-J1.3. Balanced welds

that similar practice is warranted in the case of welded members in statically loaded structures (Gibson and Wake, 1942).

However, the fatigue life of eccentrically loaded welded angles has been shown to be very short (Klöppel and Seeger, 1964). Notches at the roots of fillet welds are harmful when alternating tensile stresses are normal to the axis of the weld, as could occur due to bending when axial cyclic loading is applied to angles with end welds not balanced about the neutral axis. Accordingly, balanced welds are required when such members are subjected to cyclic loading (see Figure C-J1.3).

8. Bolts in Combination with Welds

As in previous editions, this Specification does not permit bolts to share the load with welds except for bolts in shear connections. The conditions for load sharing have, however, changed substantially based on recent research (Kulak and Grondin, 2003). For shear-resisting connections with longitudinally loaded fillet welds, load sharing between the longitudinal welds and bolts in standard holes or short-slotted holes transverse to the direction of the load is permitted, but the contribution of the bolts is limited to 50% of the available strength of the equivalent bearing-type connection. Both ASTM A307 and high-strength bolts are permitted. The heat of welding near bolts will not alter the mechanical properties of the bolts.

In making alterations to existing structures, the use of welding to resist loads other than those produced by existing dead load present at the time of making the alteration is permitted for riveted connections and high-strength bolted connections if the bolts are pretensioned to the levels in Tables J3.1 or J3.1M prior to welding.

The restrictions on bolts in combination with welds do not apply to typical bolted/welded beam-to-girder and beam-to-column connections and other comparable connections (Kulak et al., 1987).

9. High-Strength Bolts in Combination with Rivets

When high-strength bolts are used in combination with rivets, the ductility of the rivets permits the direct addition of the strengths of the two fastener types.

10. Limitations on Bolted and Welded Connections

Pretensioned bolts, slip-critical bolted connections, or welds are required whenever connection slip can be detrimental to the performance of the structure or there is a possibility that nuts will back off. Snug-tightened high-strength bolts are recommended for all other connections.

J2. WELDS

Selection of weld type [complete-joint-penetration (CJP) groove weld versus fillet versus partial-joint-penetration (PJP) groove weld] depends on base connection geometry (butt versus T or corner), in addition to required strength, and other issues discussed below. Notch effects and the ability to evaluate with nondestructive testing may affect joint selection for cyclically loaded joints or joints expected to deform plastically.

1. Groove Welds

1a. Effective Area

Tables J2.1 and J2.2 show that the effective throat of partial-joint-penetration and flare groove welds is dependent upon the weld process and the position of the weld. It is recommended that the design drawings should show either the required strength or the required effective throat size and allow the fabricator to select the process and determine the position required to meet the specified requirements. Effective throats larger than those in Table J2.2 can be qualified by tests. Weld reinforcement is not used in determining the effective throat of a groove weld but reinforcing fillets on T and corner joints are accounted for in the effective throat. See AWS D1.1/D1.1M Annex A (AWS, 2010).

1b. Limitations

Table J2.3 gives the minimum effective throat thickness of a PJP groove weld. Notice that for PJP groove welds Table J2.3 goes up to a plate thickness of over 6 in. (150 mm) and a minimum weld throat of $\frac{5}{8}$ in. (16 mm), whereas for fillet welds Table J2.4 goes up to a plate thickness of over $\frac{3}{4}$ in. (19 mm) and a minimum leg size of fillet weld of only $\frac{5}{16}$ in. (8 mm). The additional thickness for PJP groove welds is intended to provide for reasonable proportionality between weld and material thickness. The use of single-sided PJP groove welds in joints subject to rotation about the toe of the weld is discouraged.

2. Fillet Welds

2a. Effective Area

The effective throat of a fillet weld does not include the weld reinforcement, nor any penetration beyond the weld root. Some welding procedures produce a consistent penetration beyond the root of the weld. This penetration contributes to the strength of the weld. However, it is necessary to demonstrate that the weld procedure to be used produces this increased penetration. In practice, this can be done initially by cross-sectioning the runoff plates of the joint. Once this is done, no further testing is required, as long as the welding procedure is not changed.

2b. Limitations

Table J2.4 provides the minimum size of a fillet weld for a given thickness of the thinner part joined. The requirements are not based on strength considerations, but on the quench effect of thick material on small welds. Very rapid cooling of weld metal may result in a loss of ductility. Furthermore, the restraint to weld metal shrinkage provided by thick material may result in weld cracking.

The use of the thinner part to determine the minimum size weld is based on the prevalence of the use of filler metal considered to be “low hydrogen.” Because a $\frac{5}{16}$ -in. (8 mm) fillet weld is the largest that can be deposited in a single pass by the SMAW process and still be considered prequalified under AWS D1.1/D1.1M, $\frac{5}{16}$ in. (8 mm) applies to all material greater than $\frac{3}{4}$ in. (19 mm) in thickness, but

minimum preheat and interpass temperatures are required by AWS D1.1/D1.1M. The design drawings should reflect these minimum sizes, and the production welds should be of these minimum sizes.

For thicker members in lap joints, it is possible for the welder to melt away the upper corner, resulting in a weld that appears to be full size but actually lacks the required weld throat dimension. See Figure C-J2.1(a). On thinner members, the full weld throat is likely to be achieved, even if the edge is melted away. Accordingly, when the plate is $\frac{1}{4}$ in. (6 mm) or thicker, the maximum fillet weld size is $\frac{1}{16}$ in. (2 mm) less than the plate thickness, t , which is sufficient to ensure that the edge remains. See Figure C-J2.1(b).

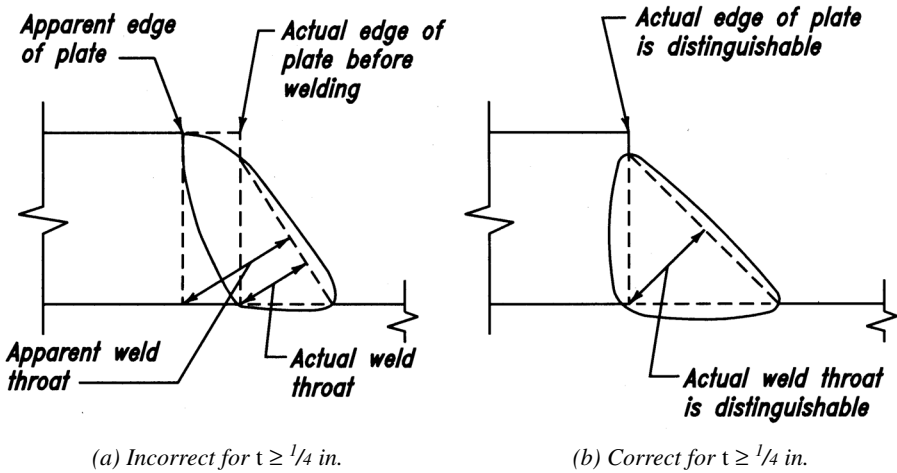

Fig. C-J2.1. Identification of plate edge.

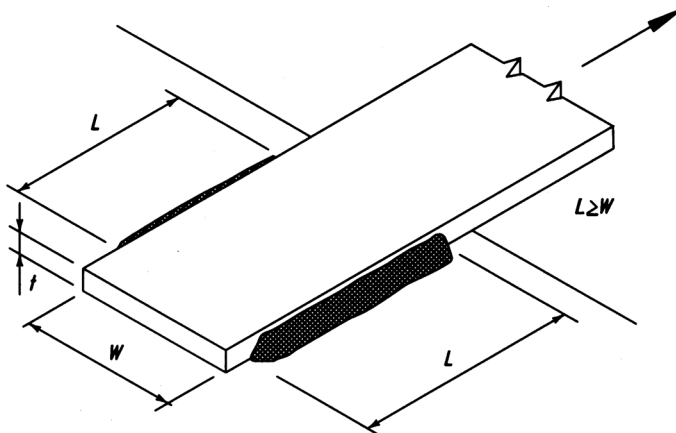

Fig. C-J2.2. Longitudinal fillet welds.

Where longitudinal fillet welds are used alone in a connection (see Figure C-J2.2), Section J2.2b requires that the length of each weld be at least equal to the width of the connecting material because of shear lag (Freeman, 1930).

By providing a minimum lap of five times the thickness of the thinner part of a lap joint, the resulting rotation of the joint when pulled will not be excessive, as shown in Figure C-J2.3. Fillet welded lap joints under tension tend to open and apply a tearing action at the root of the weld as shown in Figure C-J2.4(b), unless restrained by a force, F , as shown in Figure C-J2.4(a). The minimum length reduces stresses due to Poisson effects.

The use of single-sided fillet welds in joints subject to rotation around the toe of the weld is discouraged. End returns are not essential for developing the full length of fillet welded connections and have a negligible effect on their strength. Their use has been encouraged to ensure that the weld size is maintained over the length of the weld, to enhance the fatigue resistance of cyclically loaded flexible end connections, and to increase the plastic deformation capability of such connections.

The weld strength database on which the specifications were developed had no end returns. This includes the study reported in Higgins and Preece (1968), the seat angle tests in Lyse and Schreiner (1935), the seat and top angle tests in Lyse and Gibson (1937), the tests on beam webs welded directly to a column or girder by fillet welds in Johnston and Deits (1942), and the tests on eccentrically loaded welded connections reported by Butler et al. (1972). Hence, the current strength values and joint design models do not require end returns when the required weld size is provided. Johnston and Green (1940) noted that movement consistent with the design assumption of no end restraint (in other words, joint flexibility) was enhanced without end returns. They also verified that greater plastic deformation of the connection was achieved when end returns existed, although the strength was not significantly different.

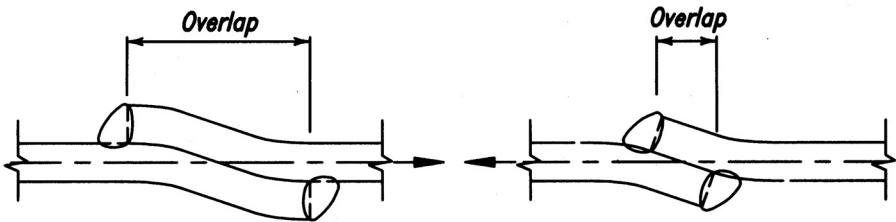

Fig. C-J2.3. Minimum lap.

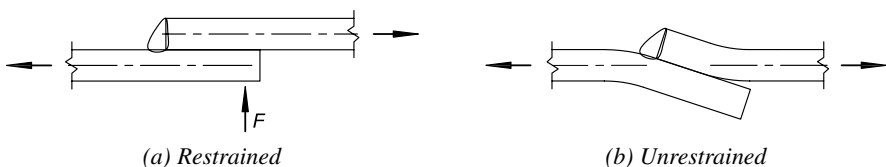

Fig. C-J2.4. Restraint of lap joints.

When longitudinal fillet welds parallel to the stress are used to transmit the load to the end of an axially loaded member, the welds are termed “end loaded.” Typical examples of such welds include, but are not limited to (a) longitudinally welded lap joints at the end of axially loaded members, (b) welds attaching bearing stiffeners, and (c) similar cases. Typical examples of longitudinally loaded fillet welds that are not considered end loaded include, but are not limited to (a) welds that connect plates or shapes to form built-up cross sections in which the shear force is applied to each increment of length of weld depending upon the distribution of the shear along the length of the member, and (b) welds attaching beam web connection angles and shear plates because the flow of shear force from the beam or girder web to the weld is essentially uniform throughout the weld length; that is, the weld is not end-loaded despite the fact that it is loaded parallel to the weld axis. Neither does the reduction coefficient, β , apply to welds attaching stiffeners to webs because the stiffeners and welds are not subject to calculated axial stress but merely serve to keep the web flat.

The distribution of stress along the length of end-loaded fillet welds is not uniform and is dependent upon complex relationships between the stiffness of the longitudinal fillet weld relative to the stiffness of the connected materials. Experience has shown that when the length of the weld is equal to approximately 100 times the weld size or less, it is reasonable to assume that the full length is effective. For weld lengths greater than 100 times the weld size, the effective length should be taken less than the actual length. The reduction factor, β , provided in Section J2.2b is the equivalent to that given in CEN (2005), which is a simplified approximation of exponential formulas developed by finite element studies and tests performed in Europe over many years. The provision is based on the combined consideration of the nominal strength for fillet welds with leg size less than $1/4$ in. (6 mm) and of a judgment-based serviceability limit of slightly less than $1/32$ in. (1 mm) displacement at the end of the weld for welds with leg size $1/4$ in. (6 mm) and larger. Given the empirically derived mathematical form of the β factor, as the ratio of weld length to weld size, w , increases beyond 300, the effective length of the weld begins to decrease, illogically causing a weld of greater length to have progressively less strength. Therefore, the effective length is taken as $0.6(300)w = 180w$ when the weld length is greater than 300 times the leg size.

In most cases, fillet weld terminations do not affect the strength or serviceability of connections. However, in certain cases the disposition of welds affect the planned function of the connection, and notches may affect the static strength and/or the resistance to crack initiation if cyclic loads of sufficient magnitude and frequency occur. For these cases, termination details at the end of the joint are specified to provide the desired profile and performance. In cases where profile and notches are less critical, terminations are permitted to be run to the end. In most cases, stopping the weld short of the end of the joint will not reduce the strength of the weld. The small loss of weld area due to stopping the weld short of the end of the joint by one to two weld sizes is not typically considered in the calculation of weld strength. Only short weld lengths will be significantly affected by this.

The following situations require special attention:

- (1) For lapped joints where one part extends beyond the end or edge of the part to which it is welded and if the parts are subject to calculated tensile stress at the start of the overlap, it is important that the weld terminate a short distance from the stressed edge. For one typical example, the lap joint between the tee chord and the web members of a truss, the weld should not extend to the edge of the tee stem (see Figure C-J2.5). The best technique to avoid inadvertent notches at this critical location is to strike the welding arc at a point slightly back from the edge and proceed with welding in the direction away from the edge (see Figure C-J2.6). Where framing angles extend beyond the end of the beam web to which they are welded, the free end of the beam web is subject to zero stress; thus, it is permissible for the fillet weld to extend continuously across the top end, along the side and along the bottom end of the angle to the extreme end of the beam (see Figure C-J2.7).

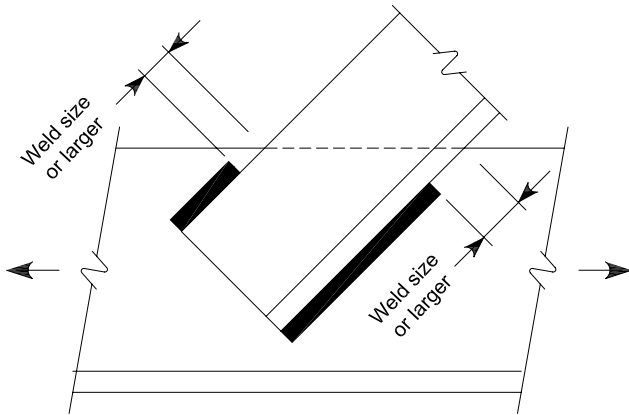

Fig. C-J2.5. Fillet welds near tension edges.

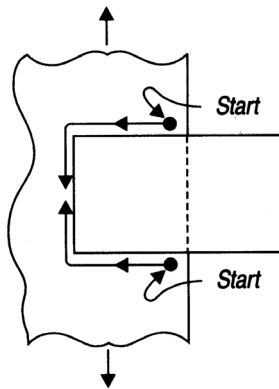

Fig. C-J2.6. Suggested direction of welding travel to avoid notches.

- (2) For connections such as framing angles and framing tees, which are assumed in the design of the structure to be *flexible connections*, the tension edges of the outstanding legs or flanges must be left unwelded over a substantial portion of their length to provide flexibility in the connection. Tests have shown that the static strength of the connection is the same with or without end returns; therefore, the use of returns is optional, but if used, their length must be restricted to not more than four times the weld size (Johnston and Green, 1940) (see Figure C-J2.8).
- (3) Experience has shown that when ends of intermediate transverse stiffeners on the webs of plate girders are not welded to the flanges (the usual practice), small torsional distortions of the flange occur near shipping bearing points in the normal course of shipping by rail or truck and may cause high out-of-plane bending stresses (up to the yield point) and fatigue cracking at the toe of the web-to-flange welds. This has been observed even with closely fitted stiffeners. The intensity of these out-of-plane stresses may be effectively limited and cracking prevented if “breathing room” is provided by terminating the stiffener weld away from the web-to-flange welds. The unwelded distance should not exceed six times the web thickness so that column buckling of the web within the unwelded length does not occur.

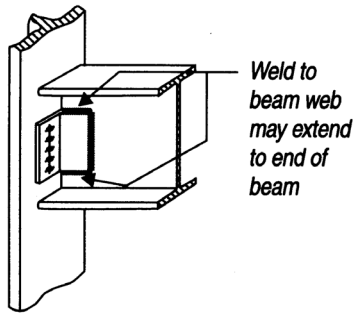

Fig. C-J2.7. Fillet weld details on framing angles.

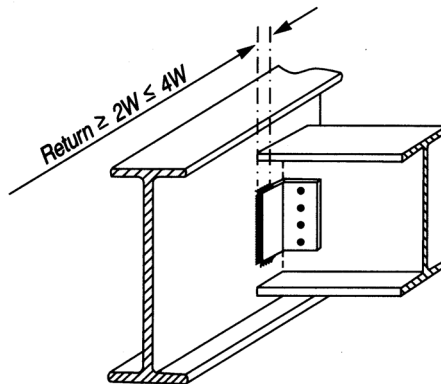

Fig. C-J2.8. Flexible connection returns optional unless subject to fatigue.

- (4) For fillet welds that occur on opposite sides of a common plane, it is difficult to deposit a weld continuously around the corner from one side to the other without causing a gouge in the corner of the parts joined; therefore, the welds must be interrupted at the corner (see Figure C-J2.9).

3. Plug and Slot Welds

A plug weld is a weld made in a circular hole in one member of a joint fusing that member to another member. A slot weld is a weld made in an elongated hole in one member of a joint fusing that member to another member. Both plug and slot welds are only applied to lap joints. Care should be taken when plug or slot welds are applied to structures subject to cyclic loading as the fatigue performance of these welds is limited.

A fillet weld inside a hole or slot is not a plug weld. A “puddle weld,” typically used for joining decking to the supporting steel, is not the same as a plug weld.

3a. Effective Area

When plug and slot welds are detailed in accordance with Section J2.3b, the strength of the weld is controlled by the size of the fused area between the weld and the base metal. The total area of the hole or slot is used to determine the effective area.

3b. Limitations

Plug and slot welds are limited to situations where they are loaded in shear, or where they are used to prevent elements of a cross section from buckling, such as for web doubler plates on deeper rolled sections. Plug and slot welds are only allowed where the applied loads result in shear between the joined materials—they are not to be used to resist direct tensile loads. This restriction does not apply to fillets in holes or slots.

The geometric limitations on hole and slot sizes are prescribed in order to provide a geometry that is conducive to good fusion. Deep, narrow slots and holes make it difficult for the welder to gain access and see the bottom of the cavity into which weld

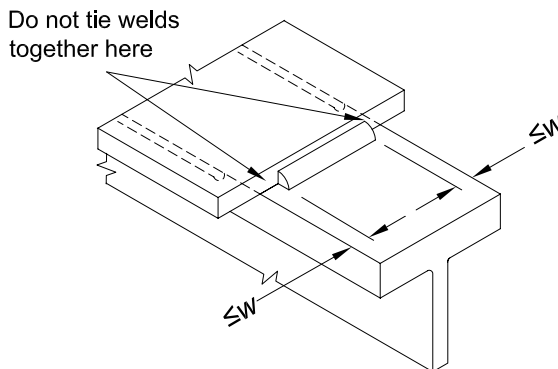

Fig. C-J2.9. Details for fillet welds that occur on opposite sides of a common plane.

metal must be placed. Where access is difficult, fusion may be limited, and the strength of the connection reduced.

4. Strength

The strength of welds is governed by the strength of either the base material or the deposited weld metal. Table J2.5 presents the nominal weld strengths and the ϕ and Ω factors, as well as the limitations on filler metal strength levels.

The strength of a joint that contains a complete-joint-penetration (CJP) groove weld, whether loaded in tension or compression, is dependent upon the strength of the base metal, and no computation of the strength of the CJP groove weld is required. For tension applications, matching strength filler metal is required, as defined in AWS D1.1/D1.1M Table 3.1. For compression applications, up to a 10 ksi (70 MPa) decrease in filler metal strength is permitted, which is equivalent to one strength level.

CJP groove welds loaded in tension or compression parallel to the weld axis, such as for the groove welded corners of box columns, do not transfer primary loads across the joint. In cases such as this, no computation of the strength of the CJP groove weld strength is required.

CJP groove welded tension joints are intended to provide strength equivalent to the base metal, therefore matching filler metal is required. CJP groove welds have been shown not to exhibit compression failure even when they are undermatched. The amount of undermatching before unacceptable deformation occurs has not been established, but one standard strength level is conservative and therefore permitted. Joints in which the weld strength is calculated based on filler metal classification strength can be designed using any filler metal strength equal to or less than matching. Filler metal selection is still subject to compliance with AWS D1.1/D1.1M.

The nominal strength of partial-joint-penetration (PJP) groove welded joints in compression is higher than for other joints because compression limit states are not observed on weld metal until significantly above the yield strength.

Connections that contain PJP groove welds designed to bear in accordance with Section J1.4(2), and where the connection is loaded in compression, are not limited in strength by the weld since the surrounding base metal can transfer compression loads. When not designed in accordance with Section J1.4(2), an otherwise similar connection must be designed considering the possibility that either the weld or the base metal may be the critical component in the connection.

The factor of 0.6 on F_{EXX} for the tensile strength of PJP groove welds is an arbitrary reduction that has been used since the early 1960s to compensate for the notch effect of the unfused area of the joint, uncertain quality in the root of the weld due to the inability to perform nondestructive evaluation, and the lack of a specific notch-toughness requirement for filler metal. It does not imply that the tensile failure mode is by shear stress on the effective throat, as in fillet welds.

Column splices have historically been connected with relatively small PJP groove welds. Frequently, erection aids are available to resist construction loads. Columns are

intended to be in bearing in splices and on base plates. Section M4.4 recognizes that, in the as-fitted product, the contact may not be consistent across the joint and therefore provides rules assuring some contact that limits the potential deformation of weld metal and the material surrounding it. These welds are intended to hold the columns in place, not to transfer the compressive loads. Additionally, the effects of very small deformation in column splices are accommodated by normal construction practices. Similarly, the requirements for base plates and normal construction practice assure some bearing at bases. Therefore the compressive stress in the weld metal does not need to be considered as the weld metal will deform and subsequently stop when the columns bear.

Other PJP groove welded joints connect members that may be subject to unanticipated loads and may fit with a gap. Where these connections are finished to bear, fit-up may not be as good as that specified in Section M4.4 but some bearing is anticipated and the weld is designed to resist loads defined in Section J1.4(2) using the factors, strengths and effective areas in Table J2.5. Where the joints connect members that are not finished to bear, the welds are designed for the total load using the available strengths and areas in Table J2.5.

In Table J2.5, the nominal strength of fillet welds is determined from the effective throat area, whereas the strengths of the connected parts are governed by their respective thicknesses. Figure C-J2.10 illustrates the shear planes for fillet welds and base material:

- (1) Plane 1-1, in which the strength is governed by the shear strength of the material A
- (2) Plane 2-2, in which the strength is governed by the shear strength of the weld metal
- (3) Plane 3-3, in which the strength is governed by the shear strength of the material B

The strength of the welded joint is the lowest of the strengths calculated in each plane of shear transfer. Note that planes 1-1 and 3-3 are positioned away from the fusion areas between the weld and the base material. Tests have demonstrated that the stress on this fusion area is not critical in determining the shear strength of fillet welds (Preece, 1968).

The shear planes for plug and PJP groove welds are shown in Figure C-J2.11 for the weld and base metal. Generally the base metal will govern the shear strength.

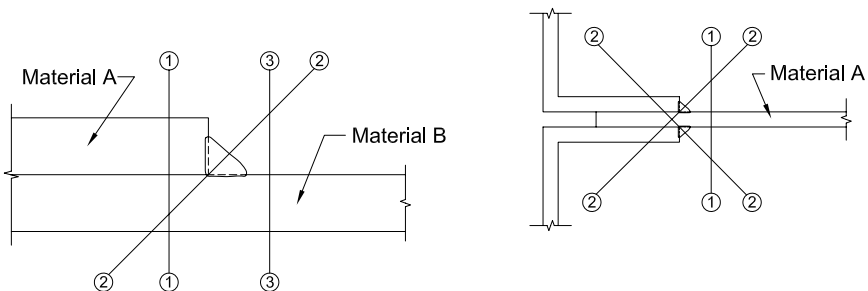

Fig. C-J2.10. Shear planes for fillet welds loaded in longitudinal shear.

When weld groups are loaded in shear by an external load that does not act through the center of gravity of the group, the load is eccentric and will tend to cause a relative rotation and translation between the parts connected by the weld. The point about which rotation tends to take place is called the instantaneous center of rotation. Its location is dependent upon the load eccentricity, geometry of the weld group, and deformation of the weld at different angles of the resultant elemental force relative to the weld axis.

The individual strength of each unit weld element can be assumed to act on a line perpendicular to a ray passing through the instantaneous center and that element's location (see Figure C-J2.12).

The ultimate shear strength of weld groups can be obtained from the load deformation relationship of a single-unit weld element. This relationship was originally given by Butler et al. (1972) for E60 (E43) electrodes. Curves for E70 (E48) electrodes were reported in Lesik and Kennedy (1990).

Unlike the load-deformation relationship for bolts, strength and deformation performance in welds are dependent on the angle that the resultant elemental force makes with the axis of the weld element as shown in Figure C-J2.12. The actual load deformation relationship for welds is given in Figure C-J2.13, taken from Lesik and Kennedy (1990). Conversion of the SI equation to U.S. customary units results in the following weld strength equation for R_n :

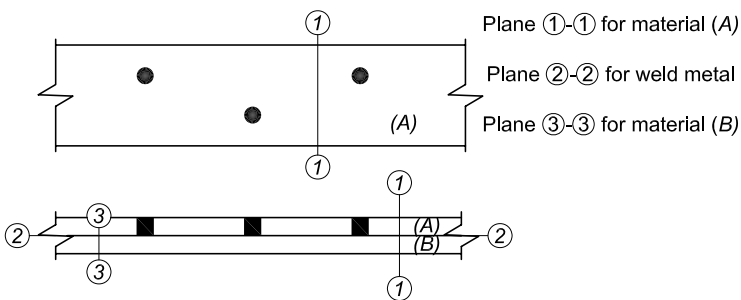

(a) Plug welds

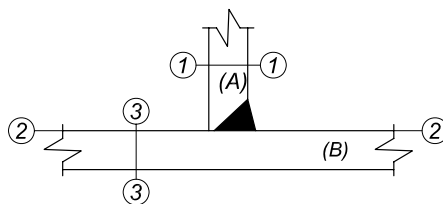

(b) Partial-joint-penetration groove welds

Fig. C-J2.11. Shear planes for plug and partial-joint-penetration groove welds.

$$R_n = 0.852(1.0 + 0.50 \sin^{1.5} \theta) F_{EXX} A_w \tag{C-J2-1}$$

Because the maximum strength is limited to $0.60F_{EXX}$ for longitudinally loaded welds ($\theta = 0^\circ$), the Specification provision provides, in the reduced equation coefficient, a reasonable margin for any variation in welding techniques and procedures. To eliminate possible computational difficulties, the maximum deformation in the weld elements is limited to $0.17w$. For design convenience, a simple elliptical formula is used for $f(p)$ to closely approximate the empirically derived polynomial in

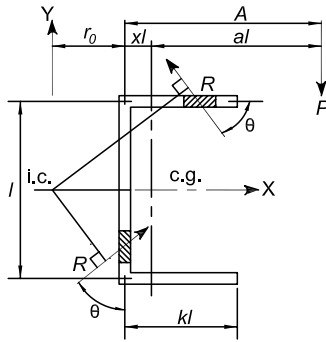

Fig. C-J2.12. Weld element nomenclature.

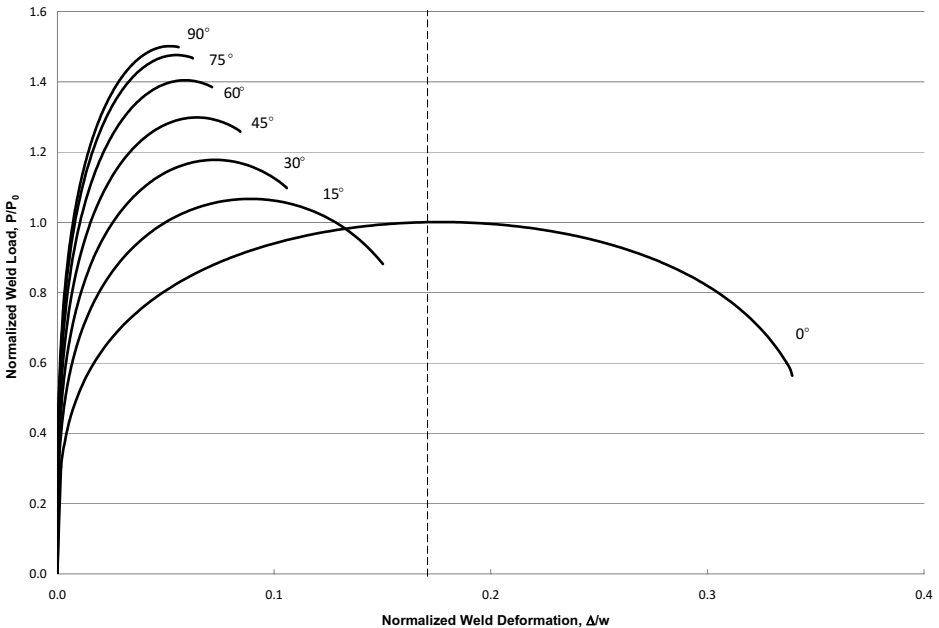

Fig. C-J2.13. Load deformation relationship.

Lesik and Kennedy (1990). Previous to 2010, the increase in fillet weld strength was restricted to weld groups loaded in the plane of the weld group elements. Testing by Gomez et al. (2008) indicated that the strength increase defined in Equation J2-5 does not have to be restricted to loads in-plane.

The total strength of all the weld elements combine to resist the eccentric load and, when the correct location of the instantaneous center has been selected, the three in-plane equations of statics ($\Sigma F_x = 0$, $\Sigma F_y = 0$, $\Sigma M = 0$) will be satisfied. Numerical techniques, such as those given in Brandt (1982), have been developed to locate the instantaneous center of rotation subject to convergent tolerances.

5. Combination of Welds

When determining the strength of a combination PJP groove weld and fillet weld contained within the same joint, the total throat dimension is not the simple addition of the fillet weld throat and the groove weld throat. In such cases, the resultant throat of the combined weld (shortest dimension from the root to face of the final weld) must be determined and the design based upon this dimension.

6. Filler Metal Requirements

Applied and residual stresses and geometrical discontinuities from backing bars with associated notch effects contribute to sensitivity to fracture. Additionally, some weld metals in combination with certain procedures result in welds with low notch toughness. Accordingly, this Specification requires a minimum specified toughness for weld metals in those joints that are subject to more significant applied stresses and toughness demands. The level of toughness required is selected as one level more conservative than the base metal requirement for hot-rolled shapes with a flange thickness exceeding 2 in. (50 mm).

7. Mixed Weld Metal

Problems can occur when incompatible weld metals are used in combination and notch-tough composite weld metal is required. For instance, tack welds deposited using a self-shielded process with aluminum deoxidizers in the electrodes and subsequently covered by SAW weld passes can result in a composite weld metal with low notch-toughness, despite the fact that each process by itself could provide notch-tough weld metal.

Potential concern about intermixing weld metal types is limited to situations where one of the two weld metals is deposited by the self-shielded flux-cored arc welding (FCAW-s) process. Changes in tensile and elongation properties have been demonstrated to be of insignificant consequence. Notch toughness is the property that can be affected the most. Many compatible combinations of FCAW-s and other processes are commercially available.

J3. BOLTS AND THREADED PARTS

1. High-Strength Bolts

In general, except as provided in this Specification, the use of high-strength bolts is required to conform to the provisions of the *Specification for Structural Joints*

Using High-Strength Bolts (RCSC, 2009) as approved by the Research Council on Structural Connections. Kulak (2002) provides an overview of the properties and use of high-strength bolts.

Occasionally the need arises for the use of high-strength bolts of diameters in excess of those permitted for ASTM A325 or A325M and ASTM A490 or A490M bolts (or lengths exceeding those available in these grades). For joints requiring diameters in excess of 1½ in. (38 mm) or lengths in excess of about 8 in. (200 mm), Section J3.1 permits the use of ASTM A449 bolts and ASTM A354 Grade BC and BD threaded rods. Note that anchor rods are more preferably specified as ASTM F1554 material.

High-strength bolts have been grouped by strength levels into two categories:

Group A bolts which have a strength similar to ASTM A325 bolts

Group B bolts which have a strength similar to ASTM A490 bolts

Snug-tightened installation is the most economical installation procedure and is permitted for bolts in bearing type connections except where pretensioning is required in the Specification. Only Group A bolts in tension or combined shear and tension and Group B bolts in shear, where loosening or fatigue are not design considerations, are permitted to be installed snug tight. Two studies have been conducted to investigate possible reductions in strength because of varying levels of pretension in bolts within the same connection. The studies found that no significant loss of strength resulted from having different pretensions in bolts within the same connection, even with ASTM A490 fasteners. See Commentary Section J3.6 for more details.

There are no specified minimum or maximum pretensions for snug-tight installation of bolts. The only requirement is that the bolts bring the plies into firm contact. Depending on the thickness of material and the possible distortion due to welding, portions of the connection may not be in contact.

There are practical cases in the design of structures where slip of the connection is desirable to allow for expansion and contraction of a joint in a controlled manner. Regardless of whether force transfer is required in the direction normal to the slip direction, the nuts should be hand-tightened with a spud wrench and then backed off one-quarter turn. Furthermore, it is advisable to deform the bolt threads or use a locking nut or jamb nut to ensure that the nut does not back off further under service conditions. Thread deformation is commonly accomplished with a cold chisel and hammer applied at one location. Note that tack-welding of the nut to the bolt threads is not recommended.

2. Size and Use of Holes

Standard holes or short slotted holes transverse to the direction of load are now permitted for all applications complying with the requirements of this Specification. In addition, to provide some latitude for adjustment in plumbing a frame during erection, three types of enlarged holes are permitted, subject to the approval of the designer. The nominal maximum sizes of these holes are given in Table J3.3 or J3.3M. The use of these enlarged holes is restricted to connections assembled with high-strength bolts and is subject to the provisions of Sections J3.3 and J3.4.

3. Minimum Spacing

The minimum spacing dimensions of $2^{2/3}$ times and 3 times the nominal diameter are to facilitate construction and do not necessarily satisfy the bearing and tearout strength requirements in Section J3.10.

4. Minimum Edge Distance

In previous editions of the Specification, separate minimum edge distances were given in Tables J3.4 and J3.4M for sheared edges and for rolled or thermally cut edges. Sections J3.10 and J4 are used to prevent exceeding bearing and tearout limits, are suitable for use with both thermally cut, sawed and sheared edges, and must be met for all bolt holes. Accordingly, the edge distances in Tables J3.4 and J3.4M are workmanship standards and are no longer dependent on edge condition or fabrication method.

5. Maximum Spacing and Edge Distance

Limiting the edge distance to not more than 12 times the thickness of an outside connected part, but not more than 6 in. (150 mm), is intended to provide for the exclusion of moisture in the event of paint failure, thus preventing corrosion between the parts that might accumulate and force these parts to separate. More restrictive limitations are required for connected parts of unpainted weathering steel exposed to atmospheric corrosion.

The longitudinal spacing applies only to elements consisting of a shape and a plate or two plates. For elements such as back-to-back angles not subject to corrosion, the longitudinal spacing may be as required for structural requirements.

6. Tension and Shear Strength of Bolts and Threaded Parts

Tension loading of fasteners is usually accompanied by some bending due to the deformation of the connected parts. Hence, the resistance factor, ϕ , and the safety factor, Ω , are relatively conservative. The nominal tensile strength values in Table J3.2 were obtained from the equation

$$F_{nt} = 0.75F_u \quad (\text{C-J3-2})$$

The factor of 0.75 included in this equation accounts for the approximate ratio of the effective tension area of the threaded portion of the bolt to the area of the shank of the bolt for common sizes. Thus A_b is defined as the area of the unthreaded body of the bolt and the value reported for F_{nt} in Table J3.2 is calculated as $0.75F_u$.

The tensile strength given by Equation C-J3-2 is independent of whether the bolt was initially installed pretensioned or snug-tightened. Tests confirm that the performance of ASTM A325 and A325M bolts in tension not subjected to fatigue are unaffected by the original installation condition (Amrine and Swanson, 2004; Johnson, 1996; Murray et al., 1992). While the equation was developed for bolted connections, it was also conservatively applied to threaded parts (Kulak et al., 1987).

For ASTM A325 or A325M bolts, no distinction is made between small and large diameters, even though the minimum tensile strength, F_u , is lower for bolts with

diameters in excess of 1 in. (25 mm). Such a refinement is not justified, particularly in view of the conservative resistance factor, ϕ , and safety factor, Ω , the increasing ratio of tensile area to gross area, and other compensating factors.

The values of nominal shear strength in Table J3.2 were obtained from the following equations rounded to the nearest whole ksi:

(a) When threads are excluded from the shear planes

$$F_{nv} = 0.563F_u \quad (\text{C-J3-3})$$

(b) When threads are not excluded from the shear plane

$$F_{nv} = 0.450F_u \quad (\text{C-J3-4})$$

The factor 0.563 accounts for the effect of a shear/tension ratio of 0.625 and a 0.90 length reduction factor. The factor of 0.450 is 80% of 0.563, which accounts for the reduced area of the threaded portion of the fastener when the threads are not excluded from the shear plane. The initial reduction factor of 0.90 is imposed on connections with lengths up to and including 38 in. (965 mm). The resistance factor, ϕ , and the safety factor, Ω , for shear in bearing-type connections in combination with the initial 0.90 factor accommodate the effects of differential strain and second-order effects in connections less than or equal to 38 in. (965 mm) in length.

In connections consisting of only a few fasteners and length not exceeding approximately 16 in. (406 mm), the effect of differential strain on the shear in bearing fasteners is negligible (Kulak et al., 1987; Fisher et al., 1978; Tide, 2010). In longer tension and compression joints, the differential strain produces an uneven distribution of load between fasteners, those near the end taking a disproportionate part of the total load, so that the maximum strength per fastener is reduced. This Specification does not limit the length but requires that the initial 0.90 factor be replaced by 0.75 when determining bolt shear strength for connections longer than 38 in. (965 mm). In lieu of another column of design values, the appropriate values are obtained by multiplying the tabulated values by $0.75/0.90 = 0.833$.

The ongoing discussion is primarily applicable to end-loaded tension and compression connections, but for connection lengths less than or equal to 38 in. (965 mm) it is applied to all connections to maintain simplicity. For shear type connections used in beams and girders, with lengths greater than 38 in. (965 mm), there is no need to make the second reduction. Examples of end-loaded and non-end-loaded connections are shown in Figure C-J3.1.

When determining the shear strength of a fastener, the area, A_b , is multiplied by the number of shear planes. While developed for bolted connections, the equations were also conservatively applied to threaded parts. The value given for ASTM A307 bolts was obtained from Equation C-J3-4 but is specified for all cases regardless of the position of threads.

Additional information regarding the development of the provisions in this section can be found in the Commentary to the RCSC *Specification* (RCSC, 2009).

In Table J3.2, footnote c, the specified reduction of 1% for each 1/16 in. over 5 diameters for ASTM A307 bolts is a carryover from the reduction that was specified for long rivets. Because the material strengths are similar, it was decided a similar reduction was appropriate.

7. Combined Tension and Shear in Bearing-Type Connections

Tests have shown that the strength of bearing fasteners subject to combined shear and tension resulting from externally applied forces can be closely defined by an ellipse (Kulak et al., 1987). The relationship is expressed as:

For design according to Section B3.3 (LRFD):

$$\left(\frac{f_t}{\phi F_{nt}} \right)^2 + \left(\frac{f_v}{\phi F_{nv}} \right)^2 = 1 \tag{C-J3-5a}$$

For design according to Section B3.4 (ASD):

$$\left(\frac{\Omega f_t}{F_{nt}} \right)^2 + \left(\frac{\Omega f_v}{F_{nv}} \right)^2 = 1 \tag{C-J3-5b}$$

where

f_v = required shear stress, ksi (MPa)

f_t = required tensile stress, ksi (MPa)

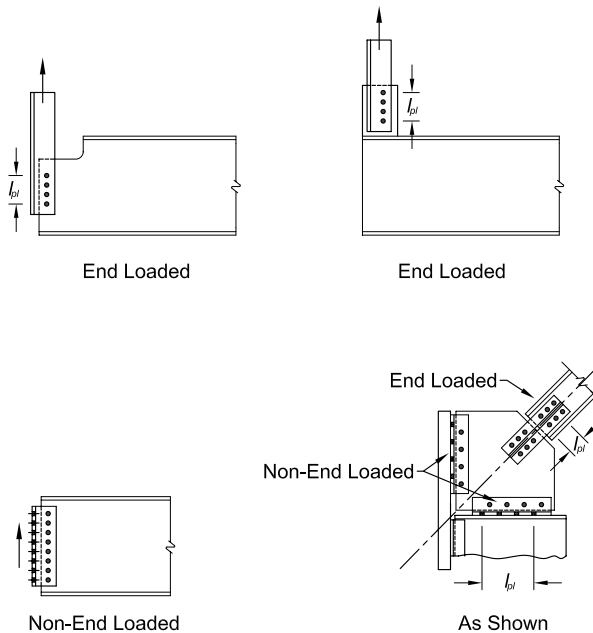

Fig. C-J3.1. End loaded and non-end-loaded connection examples;
 l_{pl} = fastener pattern length.

F_{nv} = nominal shear stress, ksi (MPa)

F_{nt} = nominal tensile stress, ksi (MPa)

The elliptical relationship can be replaced, with only minor deviations, by three straight lines as shown in Figure C-J3.2. The sloped portion of the straight-line representation follows.

For design according to Section B3.3 (LRFD):

$$\left(\frac{f_t}{\phi F_{nt}} \right) + \left(\frac{f_v}{\phi F_{nv}} \right) = 1.3 \quad (\text{C-J3-6a})$$

For design according to Section B3.4 (ASD):

$$\left(\frac{\Omega f_t}{F_{nt}} \right) + \left(\frac{\Omega f_v}{F_{nv}} \right) = 1.3 \quad (\text{C-J3-6b})$$

which results in Equations J3-3a and J3-3b (Carter et al., 1997).

This latter representation offers the advantage that no modification of either type of stress is required in the presence of fairly large magnitudes of the other type. Note that Equations J3-3a and J3-3b can be rewritten so as to find the nominal shear strength per unit area, F_{nv}' , as a function of the required tensile stress, f_t . These formulations are:

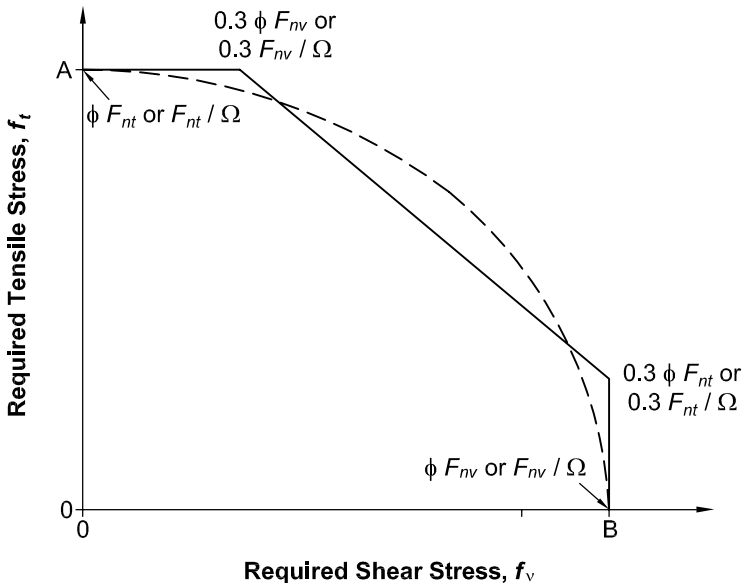

Fig. C-J3.2. Straight-line representation of elliptical solution.

For design according to Section B3.3 (LRFD):

$$F'_{nv} = 1.3F_{nv} - \frac{F_{nv}}{\phi F_{nt}} f_t \leq F_{nv} \quad (\text{C-J3-7a})$$

For design according to Section B3.4 (ASD):

$$F'_{nv} = 1.3F_{nv} - \frac{\Omega F_{nv}}{F_{nt}} f_t \leq F_{nv} \quad (\text{C-J3-7b})$$

The linear relationship was adopted for use in Section J3.7; generally, use of the elliptical relationship is acceptable (see Figure C-J3.2). A similar formulation using the elliptical solution is:

For design according to Section B3.3 (LRFD):

$$F'_{nv} = F_{nt} \sqrt{1 - \left(\frac{f_v}{\phi F_{nv}} \right)^2} \quad (\text{C-J3-8a})$$

For design according to Section B3.4 (ASD):

$$F'_{nv} = F_{nt} \sqrt{1 - \left(\frac{\Omega f_v}{F_{nv}} \right)^2} \quad (\text{C-J3-8b})$$

8. High-Strength Bolts in Slip-Critical Connections

The design provisions for slip critical connections have remained substantially the same for many years. The original provisions, using standard holes with $1/16$ in. clearance, were based on a 10% probability of slip at code loads when tightened by calibrated wrench methods. This was comparable to a design for slip at approximately 1.4 to 1.5 times code loads. Because slip resistance was considered to be a serviceability design limit state, this was determined to be an adequate safety factor. Per the RCSC *Guide to the Design Criteria for Bolted and Riveted Joints* (Kulak et al., 1987) the provisions were revised to include oversized and slotted holes (Allan and Fisher, 1968). The revised provisions included a reduction in the allowable strength of 15% for oversize holes, 30% for long slots perpendicular, and 40% for long slots parallel to the direction of the load.

Except for minor changes and adding provisions for LRFD, the design of slip-critical connections was unchanged until the 2005 AISC Specification added a higher reliability level for slip-critical connections designed for use where selected by the engineer of record. The reason for this added provision was twofold. First, the use of slip-critical connections with oversize holes had become very popular because of the economy they afforded, especially with large bolted trusses and heavy vertical bracing systems. While the Commentary to the RCSC *Specification* indicated that only the engineer of record can determine if potential slippage at service loads could reduce the ability of the frame to resist factored loads, it did not give any guidance

on how to do this. The 2005 Specification provided a procedure to design to resist slip at factored loads if slip at service loads could reduce the ability of the structure to support factored loads.

Second, many of these connection details require large filler plates. There was a question about the need to develop these fills and how to do it. The 1999 LRFD Specification stated that as an alternative to developing the filler “the joint shall be designed as slip critical.” The RCSC *Specification* stated, “The joint shall be designed as a slip-critical joint. The slip resistance of the joint shall not be reduced for the presence of fillers or shims.” Both specifications required the joint to be checked as a bearing connection, which normally would require development of large fillers.

The answer to both of these issues seemed to provide a method for designing a connection with oversize holes to resist slip at the strength level and not require the bearing strength check for the connection. In order to do this, it was necessary to first determine as closely as possible what the slip resistance currently was for oversize holes. Then it was necessary to establish what would be an adequate level of slip resistance to be able to say the connection could resist slip at factored loads.

Three major research projects formed the primary sources for the development of the 2010 Specification provisions for slip-critical connections:

- (1) Dusicka and Iwai (2007) evaluated slip-critical connections with fills for the Research Council on Structural Connections. The work provides results relevant to all slip-critical connections with fills.
- (2) Grondin et al. (2007) is a two-part study that assembles slip resistance data from all known sources and analyzes reliability of SC connections indicated by that data. A structural system configuration—a long span roof truss—is evaluated to see if slip required more reliability in slip-critical connections.
- (3) Borello et al. (2009) conducted 16 large-scale tests of slip-critical connections in both standard and oversize holes with and without thick fillers.

Deliberations considered in development and investigation of the 2010 Specification slip-critical provisions include the following:

Slip Coefficient for Class A Surfaces. Grondin et al. (2007) rigorously evaluated the test procedures and eliminated a substantial number of tests that did not meet the required protocol. The result was a recommended slip coefficient for Class A surfaces between 0.31 and 0.32. Part of the problem is the variability of what is considered to be clean mill scale. Current data on galvanized surfaces indicated more research was required and the American Galvanizers Association is sponsoring a series of tests to determine if further changes in the slip coefficient for these types of surfaces is needed.

Slip Coefficient for Class B Surfaces. Based on a review of slip tests by paint manufacturers and the results of the slip resistance of the connections (Borello et al., 2009), a slight increase in the slip coefficient for Class B surfaces might be possible, but the available data is insufficient to make a change in the 2010 Specification.

Oversized Holes and Loss of Pretension. Borello et al. (2009) confirms that there is no additional loss of pretension and that connections with oversized holes had similar slip resistance to the control group with standard holes.

Higher Pretension with Turn-of-Nut Method. The difficulty in knowing in advance what method of pretensioning would be used resulted in leaving the value of D_u at 1.13 as established for the calibrated wrench method. The Specification does, however, allow the use of a higher D_u value when approved by the engineer of record.

Shear/Bearing Strength. Borello et al. (2009) verified that connections with oversized holes, regardless of fill size, can develop the available bearing strength when the fill is developed. There was some variation in shear strength with filler size but the maximum reduction for thick fillers was approximately 15% when undeveloped.

Fillers in Slip-Critical Connections. Borello et al. (2009) indicated that filler thickness did not reduce the slip resistance of the connection. Borello et al. (2009) and Dusicka and Iwai (2007) indicated that the multiple fillers, as shown in Figure C-J3.3, reduced the slip resistance. It was determined that a factor for the number of fillers should be included in the design equation. A plate welded to the connected member or connection plate is not a filler plate and does not require this reduction factor.

The 2010 Specification provisions for slip-critical connections are based on the following conclusions:

- The mean and coefficient of variation in Class A slip-critical connections supports the use of a $\mu = 0.31$, not 0.33 or 0.35. It was expected that the use of $\mu = 0.30$ would achieve more consistent reliability while using the same resistance factors for both slip classes. The value of $\mu = 0.30$ was selected and the resistance and safety factors reflect this value.
- A factor, h_f , to reflect the use of multiple filler plates was added to the equation for nominal slip resistance resulting in

$$R_n = \mu D_u h_f T_b n_s \quad (\text{C-J3-9})$$

where

h_f = factor for fillers; coefficient to reflect the reduction in slip due to multiple fills

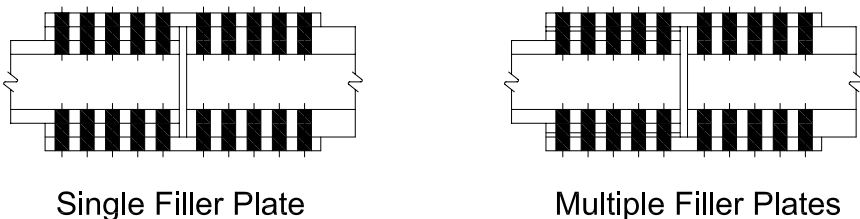

Fig C-J3.3. Single and multiple filler plate configurations.

TABLE C-J3.1
Reliability Factors, β , for Slip Resistance

Group	Class	Turn-of-Nut Method		Other Methods	
		Standard Holes	Oversized Holes	Standard Holes	Oversized Holes
Group A (A325)	Class A ($\mu = 0.30$)	2.39	2.92	1.21	1.80
	Class B ($\mu = 0.50$)	2.78	3.52	1.48	2.16
Group B (A490)	Class A ($\mu = 0.30$)	2.01	2.63	1.31	1.90
	Class B ($\mu = 0.50$)	2.47	3.20	1.60	2.28

- D_u is defined as a parameter derived from statistical analysis to calculate nominal slip resistance from statistical means developed as a function of installation method and minimum specified pretension and the level of slip probability selected.
- The surfaces of fills must be prepared to the same or higher slip coefficient as the other faying surfaces in the connection.
- The reduction in design slip resistance for oversized and slotted holes is not due to a reduction in tested slip resistance but is a factor used to reflect the consequence of slip. It was continued at the 0.85 level but clearly documented as a factor increasing the slip resistance of the connection.

The Specification also recognizes a special type of slip-resistant connection for use in built-up compression members in Section E6 where pretensioned bolts and a minimum of Class A surfaces are required but the connection is designed using the bearing strength of the bolts. This is based on the need to prevent relative movement between elements of the compression member at the ends.

Reliability levels for slip resistance in oversized holes and slots parallel to the load (given in Table C-J3.1) exceed reliability levels associated with the nominal strength of main members in the Specification when turn-of-nut pretensioning is used. Reliability of slip resistance when other tightening methods are used exceeds previous levels and is sufficient to prevent slip at load levels where inelastic deformation of the connected parts is expected. Since the effect of slip in standard holes is less than that of slip in oversized holes, the reliability factors permitted for standard holes are lower than those for oversized holes. This increased data on the reliability of these connections allowed the return to a single design level of slip resistance similar to the RCSC *Specification* (RCSC, 2009) and previous AISC Specifications.

9. Combined Tension and Shear in Slip-Critical Connections

The slip resistance of a slip-critical connection is reduced if there is applied tension. The factor, k_{sc} , is a multiplier that reduces the nominal slip resistance given by Equation J3-4 as a function of the applied tension load.

10. Bearing Strength at Bolt Holes

Provisions for bearing strength of pins differ from those for bearing strength of bolts; refer to Section J7.

Bearing strength values are provided as a measure of the strength of the material upon which a bolt bears, not as a protection to the fastener, which needs no such protection. Accordingly, the same bearing value applies to all joints assembled by bolts, regardless of fastener shear strength or the presence or absence of threads in the bearing area.

Material bearing strength may be limited either by bearing deformation of the hole or by tearout (a bolt-by-bolt block shear rupture) of the material upon which the bolt bears. Kim and Yura (1996) and Lewis and Zwerneman (1996) confirmed the bearing strength provisions for the bearing case wherein the nominal bearing strength, R_n , is equal to $CdtF_u$ and C is equal to 2.4, 3.0 or 2.0 depending upon hole type and/or acceptability of hole ovalization at ultimate load, as indicated in Section J3.10. However, this same research indicated the need for different bearing strength provisions when tearout failure would control. Appropriate equations for bearing strength as a function of clear distance, l_c , are therefore provided and this formulation is consistent with that in the RCSC *Specification* (RCSC, 2009).

Frank and Yura (1981) demonstrated that hole elongation greater than $1/4$ in. (6 mm) will generally begin to develop as the bearing force is increased beyond $2.4dtF_u$, especially if it is combined with high tensile stress on the net section, even though rupture does not occur. For a long-slotted hole with the slot perpendicular to the direction of force, the same is true for a bearing force greater than $2.0dtF_u$. An upper bound of $3.0dtF_u$ anticipates hole ovalization [deformation greater than $1/4$ in. (6 mm)] at maximum strength.

Additionally, to simplify and generalize such bearing strength calculations, the current provisions have been based upon a clear-distance formulation. Previous provisions utilized edge distances and bolt spacings measured to hole centerlines with adjustment factors to account for varying hole type and orientation, as well as minimum edge distance requirements.

A User Note has been added to this section pointing out that the effective strength of an individual bolt in shear may also be limited by the available shear strength per Section J3.6 or by the bearing per Section J3.10. The effective strength of the connection is the sum of the effective strengths of the individual bolts. This typically occurs when the effective strength of the end bolts in a connection is limited by tearout as described above. While the effective strength of some bolts in the connection may be less than others, the connection has enough ductility to allow all of the bolts to reach their individual effective strengths.

12. Tension Fasteners

With any connection configuration where the fasteners transmit a tensile force to the HSS wall, a rational analysis must be used to determine the appropriate limit states. These may include a yield-line mechanism in the HSS wall and/or pull-out through the HSS wall, in addition to applicable limit states for the fasteners subject to tension.

J4. AFFECTED ELEMENTS OF MEMBERS AND CONNECTING ELEMENTS

1. Strength of Elements in Tension

Tests have shown that for bolted splice plates yielding will occur on the gross section before the tensile strength of the net section is reached if the ratio A_n/A_g is greater than or equal to 0.85 (Kulak et al., 1987). Since the length of connecting elements is small compared to the member length, inelastic deformation of the gross section is limited. Hence, the effective net area, A_e , of the connecting element is limited to $0.85A_g$ in recognition of the limited capacity for inelastic deformation, and to provide a reserve capacity. Tests have also shown that A_e may be limited by the ability of the stress to distribute in the member. Analysis procedures such as the Whitmore section should be used to determine A_e in these cases.

2. Strength of Elements in Shear

Prior to 2005, the resistance factor for shear yielding had been 0.90, which was equivalent to a safety factor of 1.67. In ASD Specifications, the allowable shear yielding stress was $0.4F_y$, which was equivalent to a safety factor of 1.5. To make the LRFD approach in the 2005 Specification consistent with prior editions of the ASD Specification, the resistance and safety factors for shear yielding became 1.0 and 1.5, respectively. The resulting increase in LRFD design strength of approximately 10% is justified by the long history of satisfactory performance of ASD use.

3. Block Shear Strength

Tests on coped beams indicated that a tearing failure mode (rupture) can occur along the perimeter of the bolt holes as shown in Figure C-J4.1 (Birkemoe and Gilmor, 1978). This block shear mode combines tensile failure on one plane and shear failure on a perpendicular plane. The failure path is defined by the centerlines of the bolt holes.

The block shear failure mode is not limited to coped ends of beams; other examples are shown in Figures C-J4.1 and C-J4.2. The block shear failure mode must also be checked around the periphery of welded connections.

This Specification has adopted a conservative model to predict block shear strength. The mode of failure in coped beam webs and angles is different than that of gusset plates because the shear resistance is present on only one plane, in which case there must be some rotation of the block of material that is providing the total resistance.

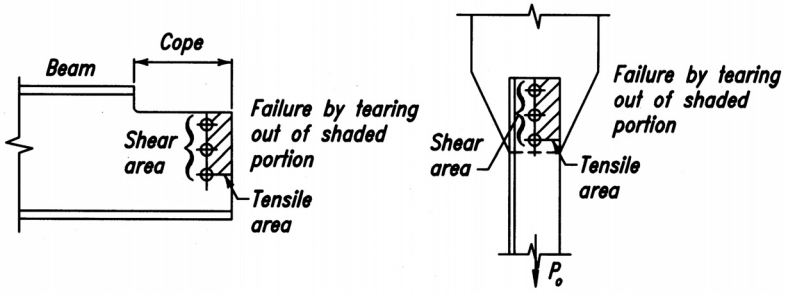
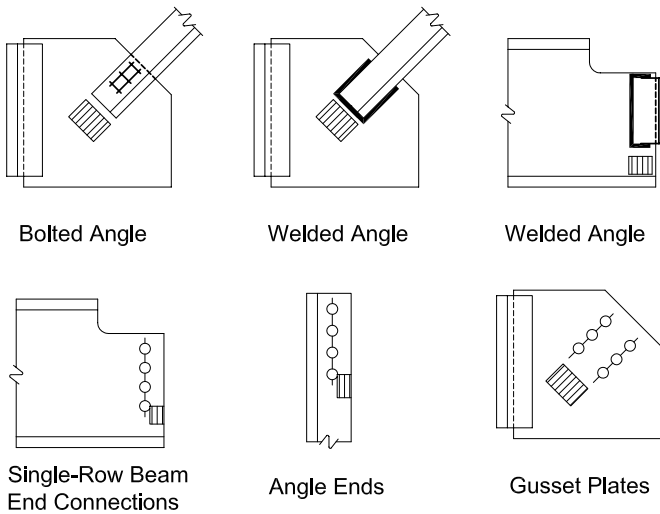
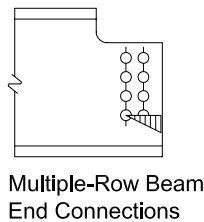

Fig. C-J4.1. Failure surface for block shear rupture limit state.



(a) Cases for which $U_{bs} = 1.0$



(b) Cases for which $U_{bs} = 0.5$

Fig. C-J4.2. Block shear tensile stress distributions.

Although tensile failure is observed through the net section on the end plane, the distribution of tensile stresses is not always uniform (Ricles and Yura, 1983; Kulak and Grondin, 2001; Hardash and Bjorhovde, 1985). A reduction factor, U_{bs} , has been included in Equation J4-5 to approximate the nonuniform stress distribution on the tensile plane. The tensile stress distribution is nonuniform in the two row connection in Figure C-J4.2(b) because the rows of bolts nearest the beam end pick up most of the shear load. For conditions not shown in Figure C-J4.2, U_{bs} may be taken as $(1 - e/l)$ where e/l is the ratio of the eccentricity of the load to the centroid of the resistance divided by the block length. This fits data reported by Kulak and Grondin (2001), Kulak and Grondin (2002), and Yura et al. (1982).

Block shear is a rupture or tearing phenomenon, not a yielding limit state. However, gross yielding on the shear plane can occur when tearing on the tensile plane commences if $0.6F_uA_{nv}$ exceeds $0.6F_yA_{gv}$. Hence, Equation J4-5 limits the term $0.6F_uA_{nv}$ to not greater than $0.6F_yA_{gv}$ (Hardash and Bjorhovde, 1985). Equation J4-5 is consistent with the philosophy in Chapter D for tension members where the gross area is used for the limit state of yielding and the net area is used for the limit state of rupture.

4. Strength of Elements in Compression

To simplify connection calculations, the nominal strength of elements in compression when the element slenderness ratio is not greater than 25 is F_yA_g . This is a very slight increase over that obtained if the provisions of Chapter E are used. For more slender elements, the provisions of Chapter E apply.

J5. FILLERS

As noted in Commentary Section J3.8, research reported in Borello et al. (2009) resulted in significant changes in the design of bolted connections with fillers. In the 2010 Specification, bearing connections with fillers over $3/4$ -in. thick are no longer required to be developed provided the bolts are designed by multiplying the shear strength by a 0.85 factor.

Slip-critical connections with a single filler of any thickness with proper surface preparation may be designed without any reduction in slip resistance. Slip-critical connections with multiple fillers may be designed without any reduction in slip resistance provided the joint has either all faying surfaces with Class B surfaces or Class A surfaces with turn-of-nut tensioning. This provision for multiple fillers is based on the additional reliability of Class B surface or on the higher pretension achieved with the turn-of-nut tensioning.

Filler plates may be used in lap joints of welded connections that splice parts of different thickness, or where there may be an offset in the joint.

J7. BEARING STRENGTH

In general, the bearing strength design of finished surfaces is governed by the limit state of bearing (local compressive yielding) at nominal loads. The nominal bearing

strength of milled contact surfaces exceeds the yield strength because adequate safety is provided by post-yield strength as deformation increases. Tests on pin connections (Johnston, 1939) and rockers (Wilson, 1934) have confirmed this behavior.

J8. COLUMN BASES AND BEARING ON CONCRETE

The provisions of this section are identical to equivalent provisions in ACI 318 (ACI, 2008).

J9. ANCHOR RODS AND EMBEDMENTS

The term “anchor rod” is used for threaded rods embedded in concrete to anchor structural steel. The term “rod” is intended to clearly indicate that these are threaded rods, not structural bolts, and should be designed as threaded parts per Table J3.2 using the material specified in Section A3.4.

Generally, the largest tensile force for which anchor rods must be designed is that produced by bending moment at the column base and augmented by any uplift caused by the overturning tendency of a building under lateral load.

Shear at the base of a column is seldom resisted by bearing of the column base plate against the anchor rods. Even considering the lowest conceivable slip coefficient, the friction due to the vertical load on a column is generally more than sufficient to transfer the shear from the column base to the foundation. The possible exception is at the base of braced frames and moment frames where larger shear forces may require that shear transfer be accomplished by embedding the column base or providing a shear key at the top of the foundation.

The anchor rod hole sizes listed in Tables C-J9.1 and C-J9.1M are recommended to accommodate the variations that are common for setting anchor rods cast in concrete. These larger hole sizes are not detrimental to the integrity of the supported structure when used with proper washers. The slightly conical hole that results from punching operations or thermal cutting is acceptable.

If plate washers are utilized to resolve horizontal shear, bending in the anchor rod must be considered in the design, and the layout of anchor rods must accommodate plate washer clearances. In this case special attention must be given to weld clearances, accessibility, edge distances on plate washers, and the effect of the tolerances between the anchor rod and the edge of the hole.

It is important that the placement of anchor rods be coordinated with the placement and design of reinforcing steel in the foundations as well as the design and overall size of base plates. It is recommended that the anchorage device at the anchor rod bottom be as small as possible to avoid interference with the reinforcing steel in the foundation. A heavy-hex nut or forged head is adequate to develop the concrete shear cone. See AISC Design Guide 1, *Base Plate and Anchor Rod Design* (Fisher and Kloiber, 2006) for design of base plates and anchor rods. See also ACI 318 (ACI, 2008) and ACI 349 (ACI, 2001) for embedment design; and OSHA *Safety and Health Regulations for Construction*, Standards—29 CFR 1926 Subpart

TABLE C-J9.1
Anchor Rod Hole Diameters, in.

Anchor Rod Diameter	Anchor Rod Hole Diameter
1/2	1 ¹ / ₁₆
5/8	1 ³ / ₁₆
3/4	1 ⁵ / ₁₆
7/8	1 ⁹ / ₁₆
1	1 ¹³ / ₁₆
1 ¹ / ₄	2 ¹ / ₁₆
1 ¹ / ₂	2 ⁵ / ₁₆
1 ³ / ₄	2 ³ / ₄
≥ 2	$d_b + 1\frac{1}{4}$

TABLE C-J9.1M
Anchor Rod Hole Diameters, mm

Anchor Rod Diameter	Anchor Rod Hole Diameter
18	32
22	36
24	42
27	48
30	51
33	54
36	60
39	63
42	74

R—Steel Erection (OSHA, 2001) for anchor rod design and construction requirements for erection safety.

J10. FLANGES AND WEBS WITH CONCENTRATED FORCES

This Specification separates flange and web strength requirements into distinct categories representing different limit states: flange local bending (Section J10.1), web local yielding (Section J10.2), web crippling (Section J10.3), web *sidesway buckling* (Section J10.4), web compression buckling (Section J10.5), and web panel-zone shear (Section J10.6). These limit state provisions are applied to two distinct types of concentrated forces normal to member flanges:

- (1) Single concentrated forces may be tensile (such as those delivered by tension hangers) or compressive (such as those delivered by bearing plates at beam interior positions, reactions at beam ends, and other bearing connections).
- (2) Double concentrated forces, one tensile and one compressive, form a couple on the same side of the loaded member, such as that delivered to column flanges through welded and bolted moment connections.

Flange local bending applies only for tensile forces, web local yielding applies to both tensile and compressive forces, and the remainder of these limit states apply only to compressive forces.

Transverse stiffeners, also called continuity plates, and web doubler plates are only required when the concentrated force exceeds the available strength given for the applicable limit state. It is often more economical to choose a heavier member than to provide such reinforcement (Carter, 1999; Troup, 1999). The demand may be determined as the largest flange force from the various load cases, although the demand may also be taken as the gross area of the attachment delivering the force multiplied by the specified minimum yield strength, F_y . Stiffeners and/or doublers and their attaching welds are sized for the difference between the demand and the applicable limit state strength. Detailing and other requirements for stiffeners are provided in Section J10.7 and Section J10.8; requirements for doublers are provided in Section J10.9.

1. Flange Local Bending

Where a tensile force is applied through a plate welded across a flange, that flange must be sufficiently rigid to prevent deformation of the flange and the corresponding high stress concentration in the weld in line with the web.

The effective column flange length for local flange bending is $12t_f$ (Graham et al., 1960). Thus, it is assumed that yield lines form in the flange at $6t_f$ in each direction from the point of the applied concentrated force. To develop the fixed edge consistent with the assumptions of this model, an additional $4t_f$, and therefore a total of $10t_f$, is required for the full flange-bending strength given by Equation J10-1. In the absence of applicable research, a 50% reduction has been introduced for cases wherein the applied concentrated force is less than $10t_f$ from the member end.

The strength given by Equation J10-1 was originally developed for moment connections but also applies to single concentrated forces such as tension hangers consisting of a plate welded to the bottom flange of a beam and transverse to the beam web. In the original tests, the strength given by Equation J10-1 was intended to provide a lower bound to the force required for weld fracture, which was aggravated by the uneven stress and strain demand on the weld caused by the flange deformation (Graham et al., 1959).

Recent tests on welds with minimum Charpy V-notch (CVN) toughness requirements show that weld fracture is no longer the failure mode when the strength given by Equation J10-1 is exceeded. Rather, it was found that the strength given by Equation J10-1 is consistently less than the force required to separate the flanges in typical column sections by $1/4$ in. (6 mm) (Hajjar et al., 2003; Prochnow et al.,

2000). This amount of flange deformation is on the order of the tolerances in ASTM A6, and it is believed that if the flange deformation exceeded this level it could be detrimental to other aspects of the performance of the member, such as flange local buckling. Although this deformation could also occur under compressive normal forces, it is customary that flange local bending is checked only for tensile forces (because the original concern was weld fracture). Therefore it is not required to check flange local bending for compressive forces.

The provision in Section J10.1 is not applicable to moment end-plate and tee-stub type connections. For these connections, see Carter (1999) or the *AISC Steel Construction Manual* (AISC, 2005b).

2. Web Local Yielding

The web local yielding provisions (Equations J10-2 and J10-3) apply to both compressive and tensile forces of bearing and moment connections. These provisions are intended to limit the extent of yielding in the web of a member into which a force is being transmitted. The provisions are based on tests on two-sided directly welded girder-to-column connections (cruciform tests) (Sherbourne and Jensen, 1957) and were derived by considering a stress zone that spreads out with a slope of 2:1. Graham et al. (1960) report pull-plate tests and suggest that a 2.5:1 stress gradient is more appropriate. Recent tests confirm that the provisions given by Equations J10-2 and J10-3 are slightly conservative and that the yielding is confined to a length consistent with the slope of 2.5:1 (Hajjar et al., 2003; Prochnow et al., 2000).

3. Web Crippling

The web crippling provisions (Equations J10-4 and J10-5) apply only to compressive forces. Originally, the term “web crippling” was used to characterize a phenomenon now called local web yielding, which was then thought to also adequately predict web crippling. The first edition of the AISC LRFD Specification (AISC, 1986) was the first AISC Specification to distinguish between local web yielding and local web crippling. Web crippling was defined as crumpling of the web into buckled waves directly beneath the load, occurring in more slender webs, whereas web local yielding is yielding of that same area, occurring in stockier webs.

Equations J10-4 and J10-5 are based on research reported in Roberts (1981). The increase in Equation J10-5b for $l_b/d > 0.2$ was developed after additional testing to better represent the effect of longer bearing lengths at ends of members (Elgaaly and Salkar, 1991). All tests were conducted on bare steel beams without the expected beneficial contributions of any connection or floor attachments. Thus, the resulting provisions are considered conservative for such applications. Kaczinski et al. (1994) reported tests on cellular box beams with slender webs and confirmed that these provisions are appropriate in this type of member as well.

The equations were developed for bearing connections but are also generally applicable to moment connections.

The web crippling phenomenon has been observed to occur in the web adjacent to the loaded flange. For this reason, a half-depth stiffener (or stiffeners) or a half-depth doubler plate is needed to eliminate this limit state.

4. Web Sidesway Buckling

The web sidesway buckling provisions (Equations J10-6 and J10-7) apply only to compressive forces in bearing connections and do not apply to moment connections. The web sidesway buckling provisions were developed after observing several unexpected failures in tested beams (Summers and Yura, 1982; Elgaaly, 1983). In those tests the compression flanges were braced at the concentrated load, the web was subjected to compression from a concentrated load applied to the flange and the tension flange buckled (see Figure C-J10.1).

Web sidesway buckling will not occur in the following cases:

- (a) For flanges restrained against rotation (such as when connected to a slab), when

$$\frac{h/t_w}{L_b/b_f} > 2.3 \quad (\text{C-J10-1})$$

- (b) For flanges *not* restrained against rotation, when

$$\frac{h/t_w}{L_b/b_f} > 1.7 \quad (\text{C-J10-2})$$

where L_b is as shown in Figure C-J10.2.

Web sidesway buckling can be prevented by the proper design of lateral bracing or stiffeners at the load point. It is suggested that local bracing at both flanges be designed for 1% of the concentrated force applied at that point. If stiffeners are used, they must extend from the load point through at least one-half the beam or girder depth. In addition, the pair of stiffeners must be designed to carry the full load. If flange rotation is permitted at the loaded flange, neither stiffeners nor doubler plates are effective.

5. Web Compression Buckling

The web compression buckling provision (Equation J10-8) applies only when there are compressive forces on both flanges of a member at the same cross section, such as might occur at the bottom flange of two back-to-back moment connections under gravity loads. Under these conditions, the slenderness of the member web must be

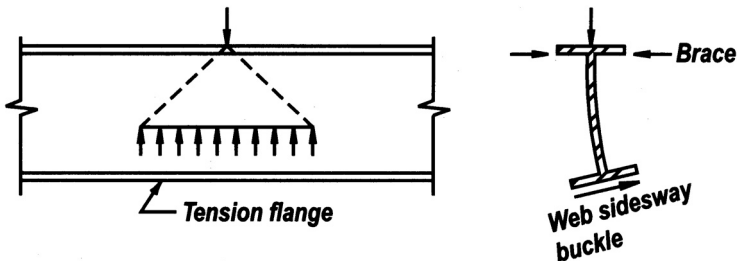

Fig. C-J10.1. Web sidesway buckling.

limited to avoid the possibility of buckling. Equation J10-8 is applicable to a pair of moment connections, and to other pairs of compressive forces applied at both flanges of a member, for which L_b/d is approximately less than 1. When L_b/d is not small, the member web should be designed as a compression member in accordance with Chapter E.

Equation J10-8 is predicated on an interior member loading condition. In the absence of applicable research, a 50% reduction has been introduced for cases wherein the compressive forces are close to the member end.

6. Web Panel-Zone Shear

Column web shear stresses may be significant within the boundaries of the rigid connection of two or more members with their webs in a common plane. Such webs must be reinforced when the required force ΣR_u for LRFD or ΣR_a for ASD along plane A-A in Figure C-J10.3 exceeds the column web available strength, ϕR_n or R_n/Ω , respectively.

For design according to Section B3.3 (LRFD):

$$\Sigma R_u = \frac{M_{u1}}{d_{m1}} + \frac{M_{u2}}{d_{m2}} - V_u \quad (\text{C-J10-3a})$$

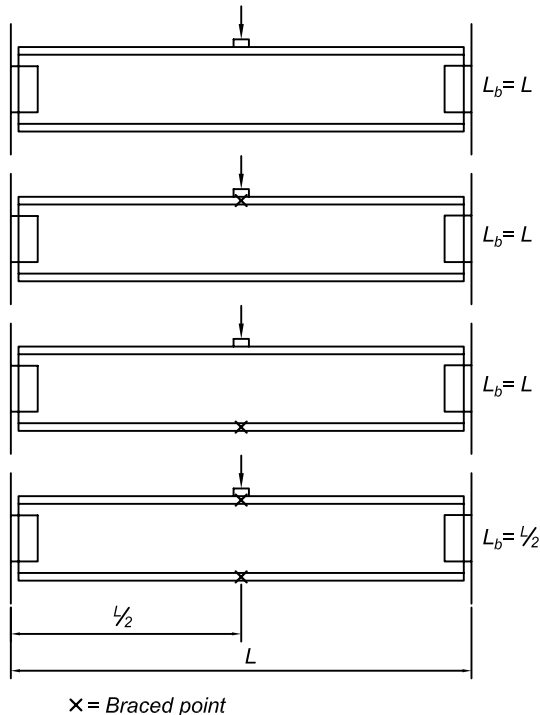

Fig. C-J10.2. Unbraced flange length for web sidesway buckling.

where

M_{u1} = $M_{u1L} + M_{u1G}$
 = sum of the moments due to the factored lateral loads, M_{u1L} , and the moments due to factored gravity loads, M_{u1G} , on the windward side of the connection, kip-in. (N-mm)

M_{u2} = $M_{u2L} - M_{u2G}$
 = difference between the moments due to the factored lateral loads M_{u2L} and the moments due to factored gravity loads, M_{u2G} , on the leeward side of the connection, kip-in. (N-mm)

d_{m1}, d_{m2} = distance between flange forces in the moment connection, in. (mm)

For design according to Section B3.4 (ASD):

$$\Sigma R_a = \frac{M_{a1}}{d_{m1}} + \frac{M_{a2}}{d_{m2}} - V_a \quad (\text{C-J10-3b})$$

where

M_{a1} = $M_{a1L} + M_{a1G}$
 = sum of the moments due to the nominal lateral loads, M_{a1L} , and the moments due to nominal gravity loads, M_{a1G} , on the windward side of the connection, kip-in. (N-mm)

M_{a2} = $M_{a2L} - M_{a2G}$
 = difference between the moments due to the nominal lateral loads, M_{a2L} , and the moments due to nominal gravity loads, M_{a2G} , on the leeward side of the connection, kip-in. (N-mm)

Historically (and conservatively), 0.95 times the beam depth has been used for d_m .

If, for LRFD $\Sigma R_u \leq \phi R_n$, or for ASD $\Sigma R_a \leq R_n/\Omega$, no reinforcement is necessary; in other words, $t_{req} \leq t_w$, where t_w is the column web thickness.

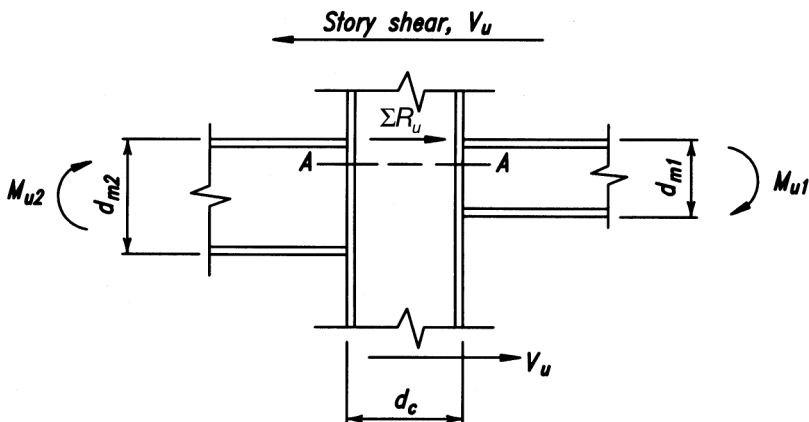

Fig. C-J10.3. LRFD forces in panel zone (ASD forces are similar).

Equations J10-9 and J10-10 limit panel-zone behavior to the elastic range. While such connection panels possess large reserve capacity beyond initial general shear yielding, the corresponding inelastic joint deformations may adversely affect the strength and stability of the frame or story (Fielding and Huang, 1971; Fielding and Chen, 1973). Panel-zone shear yielding affects the overall frame stiffness and, therefore, the resulting second-order effects may be significant. The shear/axial interaction expression of Equation J10-10, as shown in Figure C-J10.4, provides elastic panel behavior.

If adequate connection ductility is provided and the frame analysis considers the inelastic panel-zone deformations, the additional inelastic shear strength is recognized in Equations J10-11 and J10-12 by the factor

$$\left(1 + \frac{3b_{cf}t_{cf}^2}{d_b d_c t_w} \right)$$

This increase in shear strength due to inelasticity has been most often utilized for the design of frames in high seismic applications and should be used when the panel zone is designed to develop the strength of the members from which it is formed.

The shear/axial interaction expression incorporated in Equation J10-12 (see Figure C-J10.5) recognizes that when the panel-zone web has completely yielded in shear, the axial column load is resisted by the flanges.

7. Unframed Ends of Beams and Girders

Full-depth stiffeners are required at unframed ends of beams and girders not otherwise restrained to avoid twisting about their longitudinal axes. These stiffeners are full depth but not fitted. They connect to the restrained flange but do not need to continue beyond the toe of the fillet at the far flange unless connection to the far flange is necessary for other purposes, such as resisting compression from a concentrated load on the far flange.

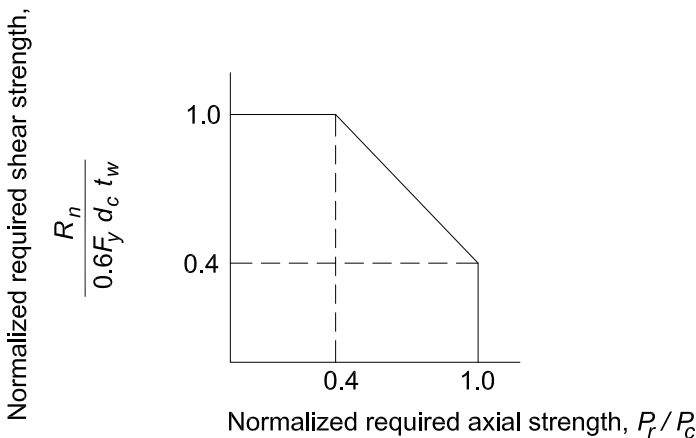

Fig. C-J10.4. Interaction of shear and axial force—elastic.

8. Additional Stiffener Requirements for Concentrated Forces

See Carter (1999), Troup (1999), and Murray and Sumner (2004) for guidelines on column stiffener design.

For rotary-straightened W-shapes, an area of reduced notch toughness is sometimes found in a limited region of the web immediately adjacent to the flange, referred to as the “*k*-area,” as illustrated in Figure C-J10.6 (Kaufmann et al., 2001). The *k*-area is defined as the region of the web that extends from the tangent point of the web and the flange-web fillet (AISC *k* dimension) a distance 1½ in. (38 mm) into the web beyond the *k* dimension. Following the 1994 Northridge Earthquake, there was a tendency to specify thicker transverse stiffeners that were groove welded to the web and flange, and thicker doubler plates that were often groove welded in the gap

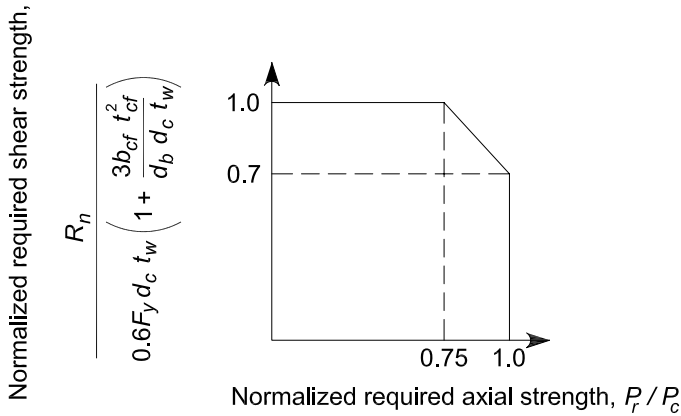

Fig. C-J10.5. Interaction of shear and axial force—inelastic.

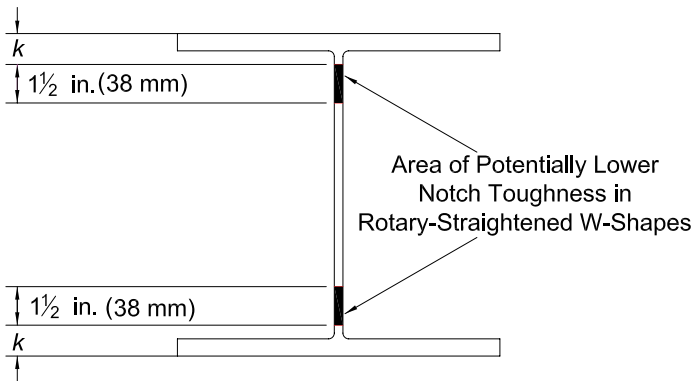

Fig. C-J10.6. Representative “*k*-area” of a wide-flange shape.

between the doubler plate and the flanges. These welds were highly restrained and may have caused cracking during fabrication in some cases (Tide, 1999). AISC (1997b) recommended that the welds for continuity plates terminate away from the *k*-area.

Recent pull-plate tests (Dexter and Melendrez, 2000; Prochnow et al., 2000; Hajjar et al., 2003) and full-scale beam-column joint testing (Bjorhovde et al., 1999; Dexter et al., 2001; Lee et al., 2002a) have shown that this problem can be avoided if the column stiffeners are fillet welded to both the web and the flange, the corner is clipped at least 1½ in. (38 mm), and the fillet welds are stopped short by a weld leg length from the edges of the cutout, as shown in Figure C-J10.7. These tests also show that groove welding the stiffeners to the flanges or the web is unnecessary, and that the fillet welds performed well with no problems. If there is concern regarding the development of the stiffeners using fillet welds, the corner clip can be made so that the dimension along the flange is ¾ in. (20 mm) and the dimension along the web is 1½ in. (38 mm).

Recent tests have also shown the viability of fillet welding doubler plates to the flanges, as shown in Figure C-J10.8 (Prochnow et al., 2000; Dexter et al., 2001; Lee et al., 2002a; Hajjar et al., 2003). It was found that it is not necessary to groove weld the doubler plates and that they do not need to be in contact with the column web to be fully effective.

9. Additional Doubler Plate Requirements for Concentrated Forces

When required, doubler plates are to be designed using the appropriate limit state requirements for the type of loading. The sum of the strengths of the member element and the doubler plate(s) must exceed the required strength and the doubler plate must be welded to the member element.

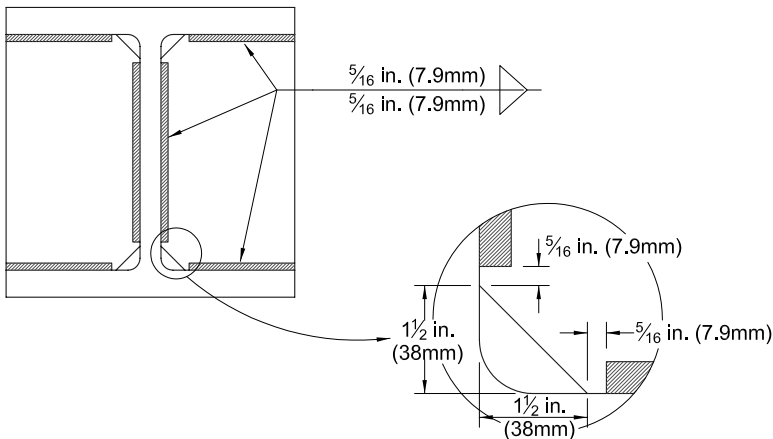

Fig. C-J10.7. Recommended placement of stiffener fillet welds to avoid contact with “*k*-area.”

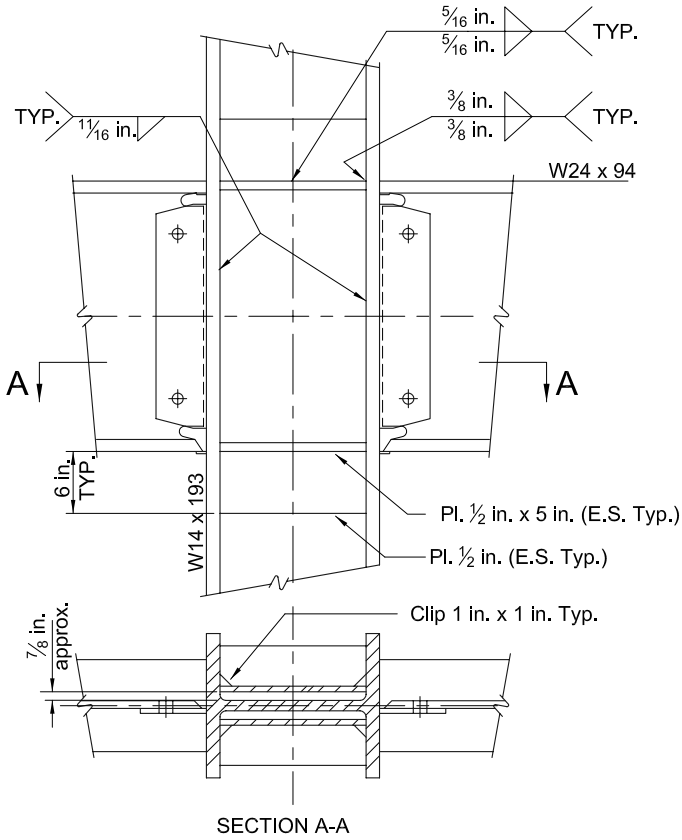

Fig. C-J10.8. Example of fillet welded doubler plate and stiffener details.

CHAPTER K

DESIGN OF HSS AND BOX MEMBER CONNECTIONS

Chapter K addresses the strength of HSS and box member welded connections. The provisions are based on failure modes that have been reported in international research on HSS, much of which has been sponsored and synthesized by CIDECT (International Committee for the Development and Study of Tubular Construction) since the 1960s. This work has also received critical review by the International Institute of Welding (IIW) Subcommittee XV-E on “Tubular Structures.” The HSS connection design recommendations are generally in accord with the design recommendations by this Subcommittee (IIW, 1989). Some minor modifications to the IIW recommended provisions for some limit states have been made by the adoption of the formulations for the same limit states elsewhere in this Specification. The IIW connection design recommendations referred to above have also been implemented and supplemented in later design guides by CIDECT (Wardenier et al., 1991; Packer et al., 1992), in the design guide by the Canadian Institute of Steel Construction (Packer and Henderson, 1997) and in CEN (2005). Parts of these IIW design recommendations are also incorporated in AWS (2010). A large amount of research data generated by CIDECT research programs up to the mid-1980s is summarized in CIDECT Monograph No. 6 (Giddings and Wardenier, 1986). Further information on CIDECT publications and reports can be obtained from their website: www.cidect.com.

The scopes of Sections K2 and K3 note that the centerlines of the branch member(s) and the chord members must lie in a single plane. For other configurations, such as multi-planar connections, connections with partially or fully flattened branch member ends, double chord connections, connections with a branch member that is offset so that its centerline does not intersect with the centerline of the chord or connections with round branch members joined to a square or rectangular chord member, the provisions of IIW (1989), CIDECT (Wardenier et al., 1991; Packer et al., 1992), CISC (Packer and Henderson, 1997; Marshall, 1992; AWS, 2010), or other verified design guidance or tests can be used.

K1. CONCENTRATED FORCES ON HSS

1. Definitions of Parameters

Some of the notation used in Chapter K is illustrated in Figure C-K1.1.

2. Round HSS

See Commentary Section K1.3.

3. Rectangular HSS

The limits of applicability in Table K1.1A stem primarily from limitations on tests conducted to date.

Sections K1.2 and K1.3, although pertaining to all concentrated forces on HSS, are particularly oriented towards plate-to-HSS welded connections. Most of the equations (after application of appropriate resistance factors for LRFD) conform to CIDECT Design Guides 1 and 3 (Wardenier et al., 1991; Packer et al., 1992) with updates in accordance with CIDECT Design Guide 9 (Kurobane et al., 2004). The latter includes revisions for longitudinal plate-to-rectangular HSS connections (Equation K1-12) based on extensive experimental and numerical studies reported in Kostasiki and Packer (2003). The provisions for the limit state of sidewall crippling of rectangular HSS, Equations K1-10 and K1-11, conform to web crippling expressions elsewhere in this Specification, and not to CIDECT or IIW recommendations. If a longitudinal plate-to-rectangular HSS connection is made by passing the plate through a slot in the HSS and then welding the plate to both the front and back HSS faces to form a “through-plate connection,” the nominal strength can be taken as twice that given by Equation K1-12 (Kostasiki and Packer, 2003), and is given in Equation K1-13.

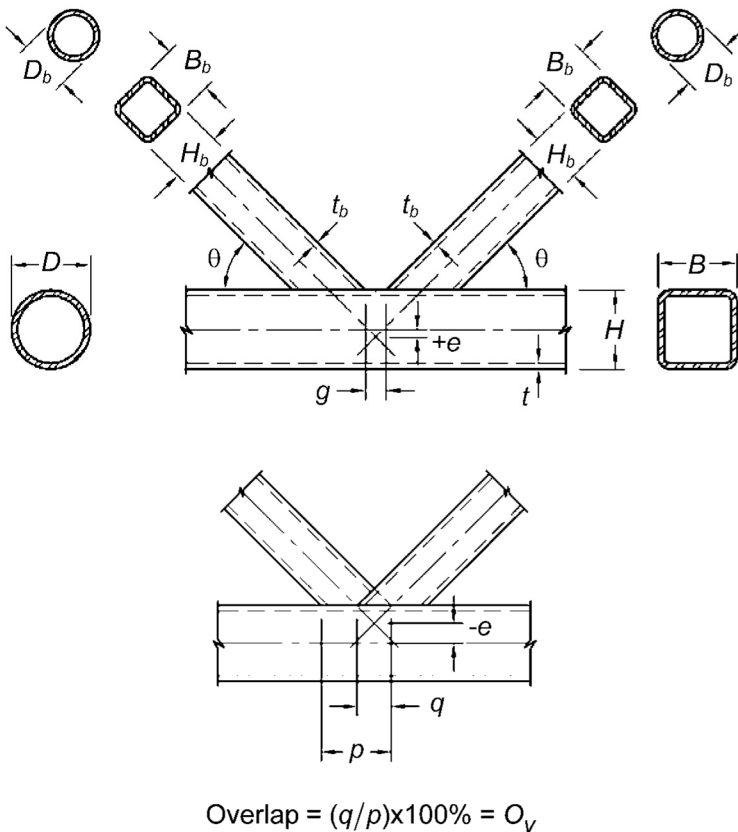

Fig. C-K1.1. Common notation for HSS connections.

The equations given for transverse plate-to-HSS connections can also be adapted for wide-flange beam-to-HSS PR moment connections, by treating the beam flanges as a pair of transverse plates and ignoring the beam web. For such wide-flange beam connections, the beam moment is thus produced by a force couple in the beam flanges. The connection flexural strength is then given by the plate-to-HSS connection strength multiplied by the distance between the beam flange centers. In Table K1.2 there is no check for the limit state of chord wall plastification for transverse plate-to-rectangular HSS connections, because this will not govern the design in practical cases. However, if there is a major compression load in the HSS, such as when it is used as a column, one should be aware that this compression load in the main member has a negative influence on the yield line plastification failure mode of the connecting chord wall (via a Q_f factor). In such a case, the designer can utilize guidance in CIDECT Design Guide No. 9 (Kurobane et al., 2004).

Tables K1.1 and K1.2 include limit states for HSS to longitudinal plate connections loaded in shear. These recommendations are based on Sherman and Ales (1991) and Sherman (1995b, 1996), where a large number of simple framing connections between wide-flange beams and rectangular HSS columns are investigated, in which the load transferred was predominantly shear. A review of costs also showed that single-plate and single-angle connections were the most economical, with double-angle and fillet-welded tee connections being more expensive. Through-plate and flare-bevel welded tee connections were among the most expensive (Sherman, 1995b). Over a wide range of connections tested, only one limit state was identified for the rectangular HSS column: punching shear failure related to end rotation of the beam, when a thick shear plate was joined to a relatively thin-walled HSS. Compliance with the inequality given by Equation K1-3 precludes this HSS failure mode. This design rule is valid providing the HSS wall is not classified as a *slender element*. An extrapolation of the inequality given by Equation K1-3 has also been made for round HSS columns, subject to the round HSS cross section not being classified as a *slender element*.

In Table K1.2, two limit states are given for the strength of a square or rectangular HSS wall with load transferred through a cap plate (or the flange of a T-stub), as shown in Figure C-K1.2. In general, the rectangular HSS could have dimensions of $B \times H$, but the illustration shows the bearing length (or width), l_b , oriented for lateral load dispersion into the wall of dimension B . A conservative distribution slope can be assumed as 2.5:1 from each face of the tee web (Wardenier et al., 1991; Kitipornchai and Traves, 1989), which produces a dispersed load width of $(5t_p + l_b)$. If this is less than B , only the two side walls of dimension B are effective in resisting the load, and even they will both be only partially effective. If $(5t_p + l_b) \geq B$, all four walls of the rectangular HSS will be engaged, and all will be fully effective; however, the cap plate (or T-stub flange) must be sufficiently thick for this to happen.

In Equations K1-14 and K1-15 the size of any weld legs has been conservatively ignored. If the weld leg size is known, it is acceptable to assume load dispersion from the toes of the welds. The same load dispersion model as shown in Figure C-K1.2 can also be applied to round HSS-to-cap plate connections.

K2. HSS-TO-HSS TRUSS CONNECTIONS

The classification of HSS truss-type connections as K- (which includes N-), Y- (which includes T-), or cross- (also known as X-) connections is based on the method of force transfer in the connection, not on the physical appearance of the connection. Examples of such classification are shown in Figure C-K2.1.

As noted in Section K2, when branch members transmit part of their load as K-connections and part of their load as T-, Y- or cross-connections, the adequacy of each branch is determined by linear interaction of the proportion of the branch load involved in each type of load transfer. One K-connection, shown in Figure C-K2.1(b), illustrates that the branch force components normal to the chord member may differ by as much as 20% and still be deemed to exhibit K-connection behavior. This is to accommodate slight variations in branch member forces along a typical truss, caused by a series of panel point loads. The N-connection in Figure C-K2.1(c), however, has a ratio of branch force components normal to the chord member of 2:1. In this case, the connection is analyzed as both a “pure” K-connection (with balanced branch forces) and a cross-connection (because the remainder of the diagonal branch load is being transferred through the connection), as shown in Figure C-K2.2. For the diagonal tension branch in that connection, the following check is also made:

$$(0.5P \sin\theta / \text{K-connection available strength}) + (0.5P \sin\theta / \text{cross-connection available strength}) \leq 1.0$$

If the gap size in a gapped K- (or N-) connection [for example, Figure C-K2.1(a)] becomes large and exceeds the value permitted by the eccentricity limit, the K-connection should be treated as two independent Y-connections. In cross-connections, such as Figure C-K2.1(e), where the branches are close together or overlapping, the

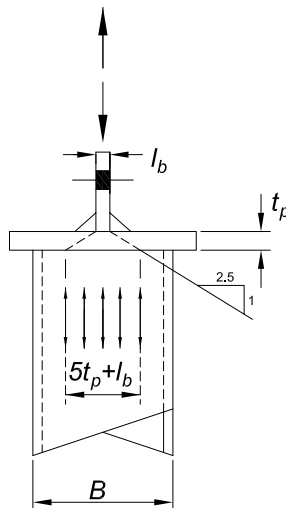

Fig. C-K1.2. Load dispersion from a concentrated force through a cap plate.

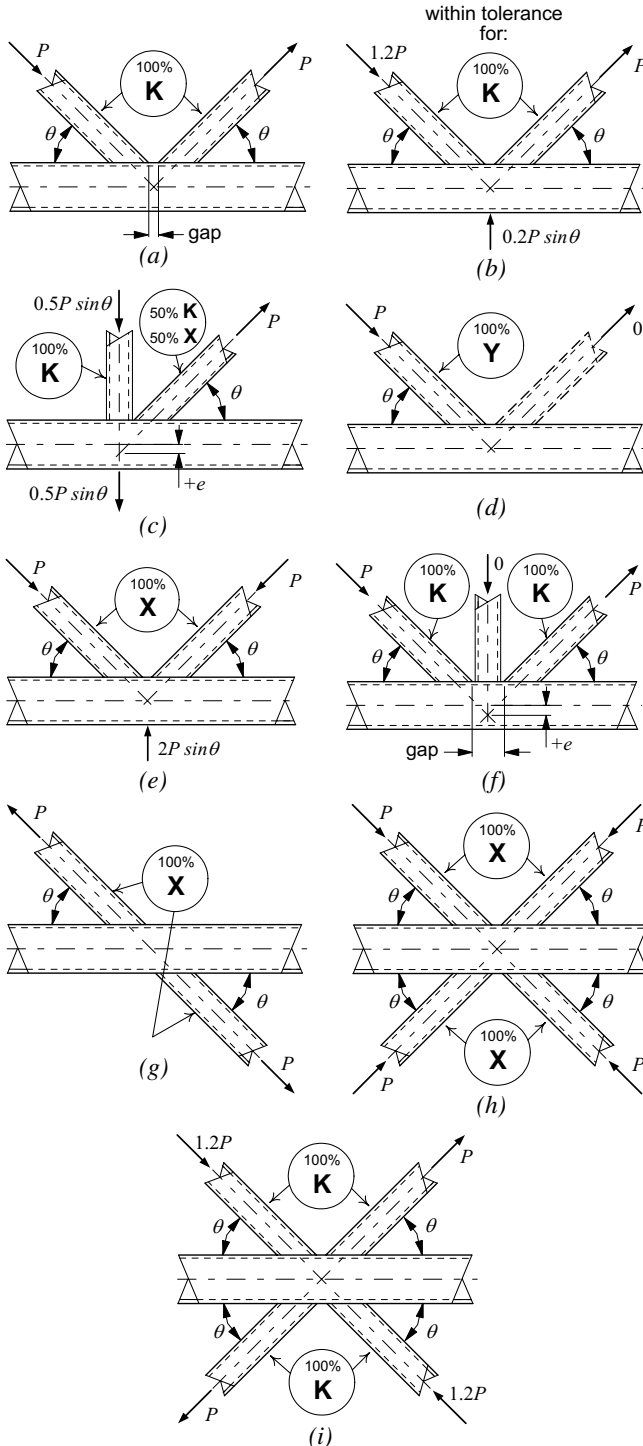

Fig. C-K2.1. Examples of HSS connection classification.

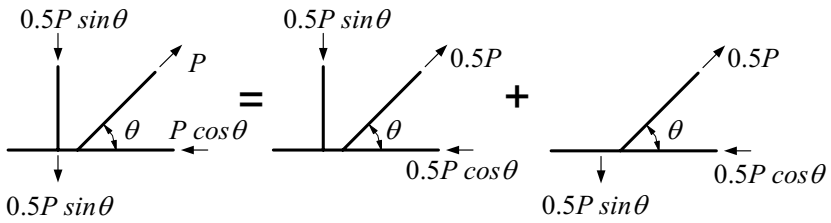

Fig. C-K2.2. Checking of K-connection with imbalanced branch member loads.

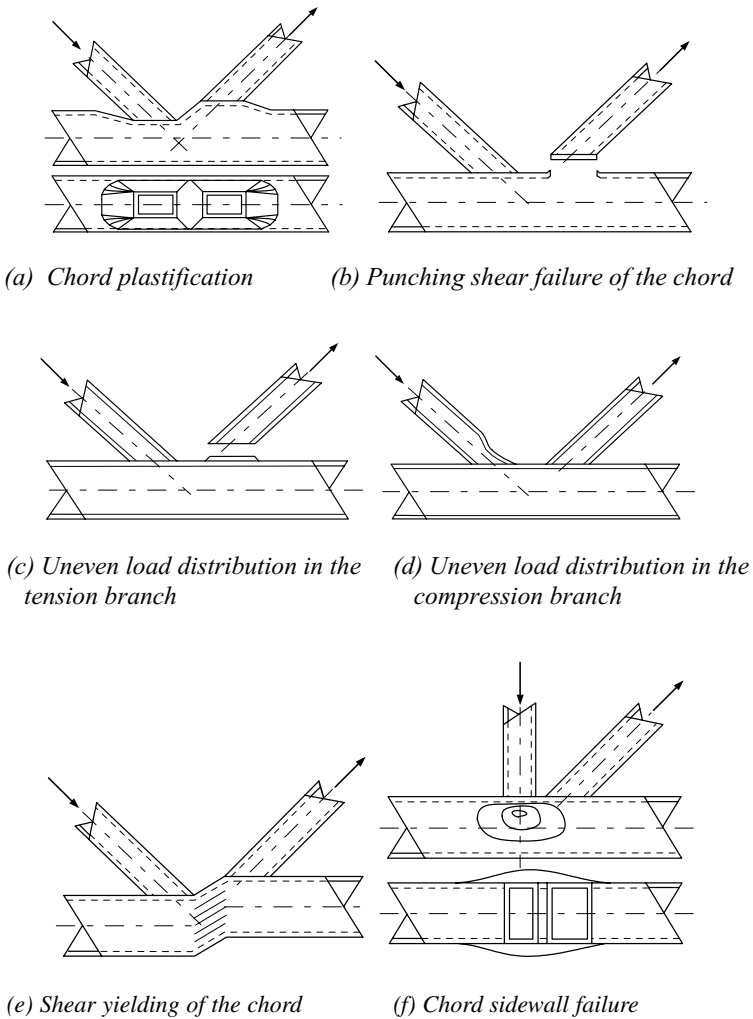

Fig. C-K2.3. Typical limit states for HSS-to-HSS truss connections.

combined “footprint” of the two branches can be taken as the loaded area on the chord member. In K-connections such as Figure C-K2.1(d), where a branch has very little or no loading, the connection can be treated as a Y-connection, as shown.

The design of welded HSS connections is based on potential limit states that may arise for a particular connection geometry and loading, which in turn represent possible failure modes that may occur within prescribed limits of applicability. Some typical failure modes for truss-type connections, shown for rectangular HSS, are given in Figure C-K2.3.

1. Definitions of Parameters

Some parameters are defined in Figure C-K1.1.

2. Round HSS

The limits of applicability in Table K2.1A generally represent the parameter range over which the equations have been verified in experiments. The following limitations bear explanation.

The minimum branch angle is a practical limit for good fabrication. Smaller branch angles are possible, but prior agreement with the fabricator should be made.

The wall slenderness limit for the compression branch is a restriction so that connection strength is not reduced by branch local buckling.

The minimum width ratio limit for gapped K-connections is based on Packer (2004), who showed that for width ratios less than 0.4, Equation K2-4 may be potentially unconservative when evaluated against proposed equations for the design of such connections by the American Petroleum Institute (API, 1993).

The restriction on the minimum gap size is only stated so that adequate space is available to enable welding at the toes of the branches to be satisfactorily performed.

The restriction on the minimum overlap is applied so that there is an adequate interconnection of the branches, to enable effective shear transfer from one branch to the other.

The provisions given in Table K2.1 for T-, Y-, cross- and K-connections are generally based, with the exception of the punching shear provision, on semi-empirical “characteristic strength” expressions, which have a confidence of 95%, taking into account the variation in experimental test results as well as typical variations in mechanical and geometric properties. These “characteristic strength” expressions are then multiplied by resistance factors for LRFD or divided by safety factors for ASD to further allow for the relevant failure mode.

In the case of the chord plastification failure mode a ϕ of 0.90 or Ω of 1.67 is applied, whereas in the case of punching shear a ϕ of 0.95 or a Ω of 1.58 is applied. The latter ϕ is 1.00 (equivalent to Ω of 1.50) in many recommendations or specifications [for example, IIW (1989), Wardenier et al. (1991), and Packer and Henderson

(1997)], to reflect the large degree of reserve strength beyond the analytical nominal strength expression, which is itself based on the shear yield (rather than ultimate) strength of the material. In this Specification, however, a ϕ of 0.95 or Ω of 1.58 is applied to maintain consistency with the factors for similar failure modes in Table K2.2.

If the tensile stress, F_u , were adopted as a basis for a punching shear rupture criterion, the accompanying ϕ would be 0.75 and Ω would be 2.00, as elsewhere in this Specification. Then, $0.75(0.6F_u) = 0.45F_u$ would yield a very similar value to $0.95(0.6F_y) = 0.57F_y$, and in fact the latter is even more conservative for HSS with specified nominal F_y/F_u ratios less than 0.79. Equation K2-1 need not be checked when $D_b > D - 2t$ because this is the physical limit at which the branch can punch into (or out of) the main tubular member.

With round HSS in axially loaded K-connections, the size of the compression branch dominates the determination of the connection strength. Hence, the term $D_{b\ comp}$ in Equation K2-4 pertains only to the compression branch and is not an average of the two branches. Thus, if one requires the connection strength expressed as a force in the tension branch, one can resolve the answer from Equation K2-4 into the direction of the tension branch, using Equation K2-5. That is, it is not necessary to repeat a calculation similar to Equation K2-4 with D_b as the tension branch. Note that the K-connection section in Table K2.2 deals with branches subject to axial loading only. This is because there should only be axial forces in the branches of a typical planar K-connection if the truss structural analysis is performed according to one of the recommended methods, which are:

- (a) pin-jointed analysis; or
- (b) analysis using web members pin-connected to continuous chord members, as shown in Figure C-K2.4.

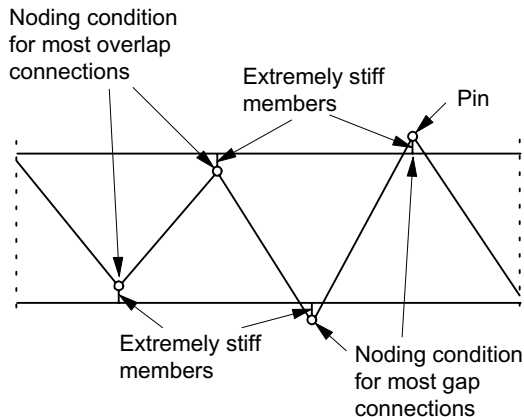

Fig. C-K2.4. Modeling assumption using web members pin-connected to continuous chord members.

3. Rectangular HSS

The limits of validity in Table K2.2A are established similarly to the limits for round HSS in Table K2.1A.

The restriction on the minimum gap ratio in Table K2.2A is modified from IIW (1989), according to Packer and Henderson (1997), to be more practical. In Table K2.2A there are two limits for the minimum gap dimension. The gap ratio (g/B) limit serves to ensure that sufficient load from a branch is transferred to the chord member sidewalls and to ensure that the demand for load transfer through the gap region is not excessive. The limit on g being at least the sum of the branch thicknesses is specified so that adequate space is available to enable welding at the toes of the branches to be satisfactorily performed.

Equation K2-7 represents an analytical yield line solution for flexure of the connecting chord face. This nominal strength equation serves to limit connection deformations and is known to be well below the ultimate connection strength. A ϕ of 1.00 or Ω of 1.50 is thus appropriate. When the branch width exceeds 85% of the chord width this yield line failure mechanism will result in a noncritical design load.

The limit state of punching shear, evident in Equations K2-8 and K2-15, is based on the effective punching shear perimeter around the branch, with the total branch perimeter being an upper limit on this length. The term β_{eop} represents the chord face effective punching shear width ratio, adjacent to one (Equation K2-15) or two (Equation K2-8) branch walls transverse to the chord axis. This β_{eop} term incorporates a ϕ of 0.80 or Ω of 1.88. Applying to generally one dimension of the rectangular branch footprint, this was deemed by AWS to be similar to a global ϕ of 0.95 or Ω of 1.58 for the whole expression, so this expression for punching shear appears in AWS (2010) with an overall ϕ of 0.95. This ϕ of 0.95 or Ω of 1.58 has been carried over to this Specification, and this topic is discussed further in Section C-K2.2. Limitations given above Equations K2-8 and K2-15 in Table K2.2 indicate when this failure mode is either physically impossible or noncritical. In particular, note that Equation K2-15 is noncritical for square HSS branches.

Equation K2-9 is generally in accord with a limit state given in IIW (1989), but with the k term [simply t in IIW (1989)] modified to be compatible with Equation K1-9, which in turn is derived from loads on I-shaped members. Equations K2-10 and K2-11 are in a format different than used internationally [for example, IIW (1989)] for this limit state and are unique to this Specification, having been replicated from Equations K1-10 and K1-11, along with their associated ϕ 's and Ω 's. These latter equations in turn are HSS versions (for two webs) of equations for I-shaped members with a single web.

The limit state of “uneven load distribution,” which is manifested by local buckling of a compression branch or premature yield failure of a tension branch, represented by Equations K2-12 and K2-16, is checked by summing the effective areas of the four sides of the branch member. For T-, Y- and cross-connections the two walls of the branch transverse to the chord are likely to be only partially effective (Equation K2-12), whereas for gapped K-connections one wall of the branch transverse to

the chord is likely to be only partially effective (Equation K2-16). This reduced effectiveness is primarily a result of the flexibility of the connecting face of the chord, as incorporated in Equations K2-13. The effective width term, b_{eoi} , has been derived from research on transverse plate-to-HSS connections (as cited below for overlapped K-connections) and incorporates a ϕ factor of 0.80 or Ω factor of 1.88. Applying the same logic described above for the limit state of punching shear, a global ϕ factor of 0.95 or Ω factor of 1.58 has been adopted in AWS D1.1/D1.1M (AWS, 2010), and this has been carried over to this Specification [although, as noted previously, a ϕ factor of 1.0 is used in IIW (1989)].

For T-, Y- and cross-connections with $\beta \leq 0.85$, the connection strength is determined by Equation K2-7 only.

For axially loaded, gapped K-connections, plastification of the chord connecting face under the “push-pull” action of the branches is by far the most prevalent and critical failure mode. Indeed, if all the HSS members are square, this failure mode is critical and Equation K2-14 is the only one to be checked. This formula for chord face plastification is a semi-empirical “characteristic strength” expression, which has a confidence of 95%, taking into account the variation in experimental test results as well as typical variations in mechanical and geometric properties. Equation K2-14 is then multiplied by a ϕ factor for LRFD or divided by an Ω factor for ASD to further allow for the failure mode and provide an appropriate safety margin. A reliability calibration (Packer et al., 1984) for this equation, using a database of 263 gapped K-connections and the exponential expression for the resistance factor (with a safety index of 3.0 and a coefficient of separation of 0.55) derived a ϕ factor of 0.89 (Ω factor of 1.69), while also imposing the parameter limits of validity. Since this failure mode dominates the test database, there is insufficient supporting test data to calibrate Equations K2-15 and K2-16.

For the limit state of shear yielding of the chord in the gap of gapped K-connections, Table K2.2 differs from international practice [for example, IIW (1989)] by recommending application of another section of this Specification, Section G5. This limit state need only be checked if the chord member is rectangular, not square, and is also oriented such that the shorter wall of the chord section lies in the plane of the truss, hence providing a more critical chord shear condition due to the short “webs.” The axial force present in the gap region of the chord member may also have an influence on the shear strength of the chord webs in the gap region.

For K-connections, the scope covers both gapped and overlapped connections. Note that the latter are generally more difficult and more expensive to fabricate than K-connections with a gap. However, an overlapped connection will, in general, produce a connection with a higher static strength and fatigue resistance, as well as a stiffer truss than its gapped connection counterpart.

Table K2.2 provisions for gapped and overlapped K-connections deal with branches subject to axial loading only. This is because there should only be axial forces in the branches of a typical planar K-connection if the truss structural analysis is performed according to one of the recommended methods, which are:

- (a) pin-jointed analysis, or
- (b) analysis using web members pin-connected to continuous chord members, as shown in Figure C-K2.4.

For rectangular HSS, the sole failure mode to be considered for design of overlapped connections is the limit state of “uneven load distribution” in the branches, manifested by either local buckling of the compression branch or premature yield failure of the tension branch. The design procedure presumes that one branch is welded solely to the chord and hence only has a single cut at its end. This can be considered “good practice” and the “thru member” is termed the overlapped member. For partial overlaps of less than 100%, the other branch is then double-cut at its end and welded to both the thru branch as well as the chord.

The branch to be selected as the “thru” or overlapped member should be the one with the larger overall width. If both branches have the same width, the thicker branch should be the overlapped branch.

For a single failure mode to be controlling (and not have failure by one branch punching into or pulling out of the other branch, for example), limits are placed on various connection parameters, including the relative width and relative thickness of the two branches. The foregoing fabrication advice for rectangular HSS also pertains to round HSS overlapped K-connections, but the latter involves more complicated profiling of the branch ends to provide good saddle fits.

Overlapped rectangular HSS K-connection strength calculations (Equations K2-17, K2-18 and K2-19) are performed initially just for the overlapping branch, regardless of whether it is in tension or compression, and then the resistance of the overlapped branch is determined from that. The equations for connection strength, expressed as a force in a branch, are based on the load-carrying contributions of the four side walls of the overlapping branch and follow the design recommendations of the International Institute of Welding (IIW, 1989; Packer and Henderson, 1997; AWS, 2010). The effective widths of overlapping branch member walls transverse to the chord (b_{eoi} and b_{eov}) depend on the flexibility of the surface on which they land, and are derived from plate-to-HSS effective width measurements (Rolloos, 1969; Wardenier et al., 1981; Davies and Packer, 1982). The constant of 10 in the b_{eoi} and b_{eov} terms has already been reduced from values determined in tests and incorporates a ϕ factor of 0.80 or Ω factor of 1.88 in those terms. Applying the same logic described above for the limit state of punching shear in T-, Y- and cross-connections, a global ϕ factor of 0.95 or Ω factor of 1.58 was adopted by AWS D1.1/D1.1M and this has been carried over to this Specification [although as noted previously a ϕ factor of 1.0 is used by IIW (1989)].

The applicability of Equations K2-17, K2-18 and K2-19 depends on the amount of overlap, O_v , where $O_v = (q/p) \times 100\%$. It is important to note that p is the projected length (or imaginary footprint) of the overlapping branch on the connecting face of the chord, even though it does not physically contact the chord. Also, q is the overlap length measured along the connecting face of the chord beneath the region of overlap of the branches. This is illustrated in Figure C-K1.1.

A maximum overlap of 100% occurs when one branch sits completely on the other branch. In such cases, the overlapping branch is sometimes moved slightly up the overlapped branch so that the heel of the overlapping branch can be fillet welded to the face of the overlapped branch. If the connection is fabricated in this manner, an overlap slightly greater than 100% is created. In such cases, the connection strength for a rectangular HSS connection can be calculated by Equation K2-19 but with the B_{bi} term replaced by another b_{ov} term. Also, with regard to welding details, it has been found experimentally that it is permissible to just tack weld the “hidden toe” of the overlapped branch, providing that the components of the two branch member forces normal to the chord substantially balance each other and providing that the welds are designed for the yield capacity of the connected branch walls. The “hidden toe” should be fully welded to the chord if the normal components of the two branch forces differ by more than 20% or the welds to the branches are designed using an effective length approach. More discussion is provided in Commentary Section K4. If the components of the two branch forces normal to the chord do in fact differ significantly, the connection should also be checked for behavior as a T-, Y- or cross-connection, using the combined footprint and the net force normal to the chord (see Figure C-K2.2).

K3. HSS-TO-HSS MOMENT CONNECTIONS

Section K3 on HSS-to-HSS connections under moment loading is applicable to frames with PR or FR moment connections, such as Vierendeel girders. The provisions of Section K3 are not generally applicable to typical planar triangulated trusses, which are covered by Section K2, since the latter should be analyzed in a manner that results in no bending moments in the web members (see Commentary Section K2). Thus, K-connections with moment loading on the branches are not covered by this Specification.

Available testing for HSS-to-HSS moment connections is much less extensive than that for axially-loaded T-, Y-, cross- and K-connections. Hence, the governing limit states to be checked for axially loaded connections have been used as a basis for the possible limit states in moment-loaded connections. Thus, the design criteria for round HSS moment connections are based on the limit states of chord plastification and punching shear failure, with ϕ and Ω factors consistent with Section K2, while the design criteria for rectangular HSS moment connections are based on the limit states of plastification of the chord connecting face, chord side wall crushing, uneven load distribution, and chord distortional failure, with ϕ and Ω factors consistent with Section K2. The “chord distortional failure” mode is applicable only to rectangular HSS T-connections with an out-of-plane bending moment on the branch. Rhomboidal distortion of the branch can be prevented by the use of stiffeners or diaphragms to maintain the rectangular cross-sectional shape of the chord. The limits of applicability of the equations in Section K3 are predominantly reproduced from Section K2. The basis for the equations in Section K3 is Eurocode 3 (CEN, 2005), which represents one of the consensus specifications on welded HSS-to-HSS connections. The equations in Section K3 have also been adopted in CIDECT Design Guide No. 9 (Kurobane et al., 2004).

K4. WELDS OF PLATES AND BRANCHES TO RECTANGULAR HSS

Section K4 consolidates all the welding rules for plates and branch members to the face of an HSS into one section. In addition to reformatting the design rules for welds of plates and gapped connections (both unchanged) into a tabular format, the weld design rules have been expanded for T-, Y- and cross-connections to include moments, as well as axial loads, and added “fit for purpose” design rules for overlapped connections.

The design of welds to branches may be performed using either of two design philosophies:

- (a) The welds may be proportioned to develop the strength of the connected branch wall, at all points along the weld length. This may be appropriate if the branch loading is complex or if the loading is not known by the weld designer. Welds sized in this manner represent an upper limit on the required weld size and may be excessively conservative in some situations.
- (b) The welds may be designed as “fit for purpose,” to resist branch forces that are typically known in HSS truss-type connections by using what is known as the “effective length concept.” Many HSS truss web members are subjected to low axial loads and, in such situations, this weld design philosophy is ideal. However, the nonuniform loading of the weld perimeter due to the flexibility of the connecting HSS face must be taken into account by using weld effective lengths. Suitable effective lengths for plates and various rectangular HSS connections subject to branch axial loading (and/or moment loading in some cases) are given in Table K4.1. Several of these provisions are similar to those given in AWS (2010) and are based on full-scale HSS connection and truss tests that studied weld failures (Frater and Packer, 1992a, 1992b; Packer and Cassidy, 1995). Others (the newly added rules for moments in T-, Y- and cross-connections and axial forces in overlapped connections) are based on a rational extrapolation of the effective length concept used for design of the member itself. Diagrams which show the locations of the effective weld lengths (most of which are less than 100% of the total weld length) are shown in Table K4.1. This effective length approach to weld design recognizes that a branch to main member connection becomes stiffer along its edges, relative to the center of the HSS face, as the angle of the branch to the connecting face and/or the width ratio (the width of a branch member relative to the connecting face) increase. Thus, the effective length used for sizing the weld may decrease as either the angle of the branch member (when over 50° relative to the connecting face) or the branch member width (creating width ratios over 0.85) increase. Note that for ease of calculation and because the error is insignificant, the weld corners were assumed as square for determination of the weld line section properties in certain cases.

As noted in Commentary Section K2, when the welds in overlapped joints are adequate to develop the strength of the remaining member walls, it has been found experimentally that it is permissible to tack weld the “hidden toe” of the overlapped branch, providing that the components of the two branch member forces normal to the chord substantially balance each other. The “hidden toe” should be fully welded

to the chord if the normal components of the two branch forces differ by more than 20%. If the “fit for purpose” weld design philosophy is used in an overlapped joint the hidden weld should be completed even though the effective weld length may be much less than the perimeter of the tube. This helps account for the moments that can occur in typical HSS connections due to joint rotations and face deformations but are not directly accounted for in design.

Until further investigation proves otherwise, directional strength increases typically used in the design of fillet welds are not allowed in Section K4 when welding to the face of HSS members in truss-type connections. Additionally, the design weld size in all cases shown in Table K4.1, including the hidden weld underneath an overlapped member as discussed above, is the smallest weld throat around the connection perimeter; adding up the strengths of individual sections of a weld group with varying throat sizes around the perimeter of the cross section is not a viable approach to HSS connection design.

CHAPTER L

DESIGN FOR SERVICEABILITY

L1. GENERAL PROVISIONS

Serviceability limit states are conditions in which the functions of a building are impaired because of local damage, deterioration or deformation of building components, or occupant discomfort. While serviceability limit states generally do not involve collapse of a building, loss of life or injury, they can seriously impair the building's usefulness and lead to costly repairs and other economic consequences. Serviceability provisions are essential to provide satisfactory performance of building structural systems. Neglect of serviceability may result in structures that are excessively flexible or otherwise perform unacceptably in service.

The three general types of structural behavior that are indicative of impaired serviceability in steel structures are:

- (1) Excessive deflections or rotations that may affect the appearance, function or drainage of the building or may cause damaging transfer of load to nonstructural components and attachments;
- (2) Excessive vibrations produced by the activities of the building occupants, mechanical equipment or wind effects, which may cause occupant discomfort or malfunction of building service equipment; and
- (3) Excessive local damage (local yielding, buckling, slip or cracking) or deterioration (weathering, corrosion and discoloration) during the service life of the structure.

Serviceability limit states depend on the occupancy or function of the building, the perceptions of its occupants, and the type of structural system. Limiting values of structural behavior intended to provide adequate levels of serviceability should be determined by a team consisting of the building owner/developer, the architect and the structural engineer after a careful analysis of all functional and economic requirements and constraints. In arriving at serviceability limits, the team should recognize that building occupants are able to perceive structural deformations, motions, cracking or other signs of distress at levels that are much lower than those that would indicate impending structural damage or failure. Such signs of distress may be viewed as an indication that the building is unsafe and diminish its economic value, and therefore must be considered at the time of design.

Service loads that may require consideration in checking serviceability include: (1) static loads from the occupants, snow or rain on the roof, or temperature fluctuations; and (2) dynamic loads from human activities, wind effects, the operation of mechanical or building service equipment, or traffic near the building. Service loads are loads that act on the structure at an arbitrary point in time, and may be only a fraction of the corresponding nominal load. The response of the structure to service loads generally can be analyzed assuming elastic behavior. Members that accumulate

residual deformations under service loads also may require examination with respect to this long-term behavior.

Serviceability limit states and appropriate load combinations for checking conformance to serviceability requirements can be found in ASCE/SEI 7, *Minimum Design Loads for Buildings and Other Structures*, Appendix C, and the Commentary Appendix C (ASCE, 2010).

L2. CAMBER

Camber is frequently specified in order to provide a level surface under *permanent loads*, for reasons of appearance or for alignment with other work. In normal circumstances camber does nothing to prevent excessive deflection or vibration. Camber in trusses is normally created by adjustment of member lengths prior to making shop connections. It is normally introduced in beams by controlled heating of selected portions of the beam or by cold bending, or both. Designers should be aware of practical limits presented by normal fabricating and erection practices. The *Code of Standard Practice for Steel Buildings and Bridges* (AISC, 2010a) provides tolerances on actual camber and recommends that all cambers be measured in the fabricating shop on unstressed members, along general guidelines. Further information on camber may be found in Ricker (1989) and Bjorhjojde (2006).

L3. DEFLECTIONS

Excessive vertical deflections and misalignment arise primarily from three sources: (1) gravity loads, such as dead, live and snow loads; (2) effects of temperature, creep and differential settlement; and (3) construction tolerances and errors. Such deformations may be visually objectionable; cause separation, cracking or leakage of exterior cladding, doors, windows and seals; and cause damage to interior components and finishes. Appropriate limiting values of deformations depend on the type of structure, detailing and intended use (Galambos and Ellingwood, 1986). Historically, common deflection limits for horizontal members have been 1/360 of the span for floors subjected to reduced live load and 1/240 of the span for roof members. Deflections of about 1/300 of the span (for cantilevers, 1/150 of the length) are visible and may lead to general architectural damage or cladding leakage. Deflections greater than 1/200 of the span may impair operation of moveable components such as doors, windows and sliding partitions.

Deflection limits depend very much on the function of the structure and the nature of the supported construction. Traditional limits expressed as a fraction of the span length should not be extrapolated beyond experience. For example, the traditional limit of 1/360 of the span worked well for controlling cracks in plaster ceilings with spans common in the first half of the twentieth century. Many structures with more flexibility have performed satisfactorily with the now common, and more forgiving, ceiling systems. On the other hand, with the advent of longer structural spans, serviceability problems have been observed with flexible grid ceilings where actual deflections were far less than 1/360 of the span, because the distance between partitions or other elements that may interfere with ceiling deflection are far less than the span of the structural member. Proper control of deflections is a complex subject

requiring careful application of professional judgment. West et al. (2003) provide an extensive discussion of the issues.

Deflection computations for composite beams should include an allowance for slip, creep and shrinkage (see Commentary Section I3).

In certain long-span floor systems, it may be necessary to place a limit, independent of span, on the maximum deflection to minimize the possibility of damage of adjacent nonstructural elements (ISO, 1977). For example, damage to nonload-bearing partitions may occur if vertical deflections exceed more than about $3/8$ in. (10 mm) unless special provision is made for differential movement (Cooney and King, 1988); however, many components can and do accept larger deformations.

Load combinations for checking static deflections can be developed using first-order reliability analysis (Galambos and Ellingwood, 1986). Current static deflection guidelines for floor and roof systems are adequate for limiting superficial damage in most buildings. A combined load with an annual probability of being exceeded of 5% is appropriate in most instances. For serviceability limit states involving visually objectionable deformations, repairable cracking or other damage to interior finishes, and other short-term effects, the suggested load combinations are:

$$D + L$$

$$D + 0.5S$$

For serviceability limit states involving creep, settlement or similar long-term or permanent effects, the suggested load combination is:

$$D + 0.5L$$

The dead load effect, D , may be that portion of dead load that occurs following attachment of nonstructural elements. For example, in composite construction, the dead load effects frequently are taken as those imposed after the concrete has cured. For ceiling related calculations, the dead load effects may include only those loads placed after the ceiling structure is in place.

L4. DRIFT

Drift (lateral deflection) in a steel building is a serviceability issue primarily from the effects of wind. Drift limits are imposed on buildings to minimize damage to cladding and to nonstructural walls and partitions. Lateral frame deflection is evaluated for the building as a whole, where the applicable parameter is the *total building drift*, defined as the lateral frame deflection at the top of the most occupied floor divided by the height of the building to that level, Δ/H . For each floor, the applicable parameter is *interstory drift*, defined as the lateral deflection of a floor relative to the lateral deflection of the floor immediately below, divided by the distance between floors, $(\delta_n - \delta_{n-1})/h$.

Typical drift limits in common usage vary from $H/100$ to $H/600$ for total building drift and $h/200$ to $h/600$ for interstory drift, depending on building type and the type of cladding or partition materials used. The most widely used values are H (or h)/400

to H (or h)/500 (ASCE Task Committee on Drift Control of Steel Building Structures, 1988). An absolute limit on *interstory drift* is sometimes imposed by designers in light of evidence that damage to nonstructural partitions, cladding and glazing may occur if the interstory drift exceeds about $\frac{3}{8}$ in. (10 mm), unless special detailing practices are employed to accommodate larger movements (Cooney and King, 1988; Freeman, 1977). Many components can accept deformations that are significantly larger. More specific information on the damage threshold for building materials is available in the literature (Griffis, 1993).

It is important to recognize that frame racking or shear distortion (in other words, strain) is the real cause of damage to building elements such as cladding and partitions. Lateral drift only captures the horizontal component of the racking and does not include potential vertical racking, as from differential column shortening in tall buildings, which also contributes to damage. Moreover, some lateral drift may be caused by rigid body rotation of the cladding or partition which by itself does not cause strain and therefore damage. A more precise parameter, the *drift damage index*, used to measure the potential damage, has been proposed (Griffis, 1993).

It must be emphasized that a reasonably accurate estimate of building drift is essential to controlling damage. The structural analysis must capture all significant components of potential frame deflection including flexural deformation of beams and columns, axial deformation of columns and braces, shear deformation of beams and columns, beam-column joint rotation (panel-zone deformation), the effect of member joint size, and the P - Δ effect (Charney, 1990). For many low-rise steel frames with normal bay widths of 30 to 40 ft (9 to 12 m), use of center-to-center dimensions between columns without consideration of actual beam column joint size and panel zone effects will usually suffice for checking drift limits. The stiffening effect of nonstructural cladding, walls and partitions may be taken into account if substantiating information (stress versus strain behavior) regarding their effect is available.

The level of wind load used in drift limit checks varies among designers depending upon the frequency with which the potential damage can be tolerated. Some designers use the same nominal wind load (wind load specified by the building code without a load factor) as used for the strength design of the members (typically a 50 or 100 year mean recurrence interval wind load). Other designers use a 10 year or 20 year mean recurrence interval wind load (Griffis, 1993; ASCE, 2010). Use of factored wind loads (nominal wind load multiplied by the wind load factor) is generally considered to be very conservative when checking serviceability.

It is important to recognize that drift control limits by themselves in wind-sensitive buildings do not provide comfort of the occupants under wind load. See Section L6 for additional information regarding perception of motion in wind sensitive buildings.

L5. VIBRATION

The increasing use of high-strength materials with efficient structural systems and open plan architectural layouts leads to longer spans and more flexible floor systems

having less damping. Therefore, floor vibrations have become an important design consideration. Acceleration is the recommended standard for evaluation.

An extensive treatment of vibration in steel-framed floor systems and pedestrian bridges is found in Design Guide 11, *Floor Vibrations Due to Human Activity* (Murray et al., 1997). This guide provides basic principles and simple analytical tools to evaluate steel-framed floor systems and footbridges for vibration serviceability due to human activities, including walking and rhythmic activities. Both human comfort and the need to control movement for sensitive equipment are considered.

L6. WIND-INDUCED MOTION

Designers of wind-sensitive buildings have long recognized the need for controlling annoying vibrations under the action of wind to protect the psychological well-being of the occupants (Chen and Robertson, 1972). The perception of building motion under the action of wind may be described by various physical quantities including maximum displacement, velocity, acceleration, and rate of change of acceleration (sometimes called “jerk”). Acceleration has become the standard for evaluation because it is readily measured in the field and can be easily calculated analytically. Human response to building motion is a complex phenomenon involving many psychological and physiological factors. Perception and tolerance thresholds of acceleration as a measure of building motion are known to depend on factors such as frequency of the building, occupant gender, age, body posture (sitting, standing or reclining), body orientation, expectation of motion, body movement, visual cues, acoustic clues, and the type of motion (translational or torsional) (ASCE, 1981). Different thresholds and tolerance levels exist for different people and responses can be very subjective. It is known that some people can become accustomed to building motion and tolerate higher levels than others. Limited research exists on this subject but certain standards have been applied for design as discussed below.

Acceleration in wind-sensitive buildings may be expressed as either root mean square (RMS) or peak acceleration. Both measures are used in practice and there is no clear agreement as to which is the more appropriate measure of motion perception. Some researchers believe that peak acceleration during wind storms is a better measure of actual perception but that RMS acceleration during the entire course of a wind storm is a better measure of actual discomfort. Target peak accelerations of 21 milli-g (0.021 times the acceleration of gravity) for commercial buildings (occupied mostly during daylight hours) and 15 milli-g for residential buildings (occupied during the entire day) under a 10-year mean recurrence interval wind storm have been successfully used in practice for many tall building designs (Griffis, 1993). The target is generally more strict for residential buildings because of the continuous occupancy, the perception that people are less sensitive and more tolerant at work than at home, the fact that there is more turnover in commercial buildings, and the fact that commercial buildings are more easily evacuated for peak wind events. Peak acceleration and RMS acceleration in wind-sensitive buildings are related by the “peak factor” best determined in a wind tunnel study and generally in the range of 3.5 for tall buildings (in other words, peak acceleration = peak

factor \times RMS acceleration). Guidance for design acceleration levels used in building design may be found in the literature (Chen and Robertson, 1972; Hansen et al., 1973; Irwin, 1986; NRCC, 1990; Griffis, 1993;).

It is important to recognize that perception to building motion is strongly influenced by building mass and available damping as well as stiffness (Vickery et al., 1983). For this reason, building drift limits by themselves should not be used as the sole measure of controlling building motion (Islam et al., 1990). Damping levels for use in evaluating building motion under wind events are generally taken as approximately 1% of critical damping for steel buildings.

L7. EXPANSION AND CONTRACTION

The satisfactory accommodation of expansion and contraction cannot be reduced to a few simple rules, but must depend largely upon the judgment of a qualified engineer.

The problem is likely to be more serious in buildings with masonry walls than with prefabricated units. Complete separation of the framing at widely spaced expansion joints is generally more satisfactory than more frequently located devices that depend upon the sliding of parts in bearing, and usually less expensive than rocker or roller expansion bearings.

Creep and shrinkage of concrete and yielding of steel are among the causes, other than temperature, for dimensional changes. Conditions during construction, such as temperature effects before enclosure of the structure, should also be considered.

Guidelines for the recommended size and spacing of expansion joints in buildings may be found in NRC (1974).

L8. CONNECTION SLIP

In bolted connections with bolts in holes having only small clearances, such as standard holes and slotted holes loaded transversely to the axis of the slot, the amount of possible slip is small. Slip at these connections is not likely to have serviceability implications. Possible exceptions include certain unusual situations where the effect of slip is magnified by the configuration of the structure, such as a connection at the base of a shallow cantilever beam or post where a small amount of bolt slip may produce unacceptable rotation and deflection.

This Specification requires that connections with oversized holes or slotted holes loaded parallel to the axis of the slot be designed as slip-critical connections. For a discussion of slip at these connections, see the Commentary Section J3.8. Where slip at service loads is a realistic possibility in these connections, the effect of connection slip on the serviceability of the structure must be considered.

CHAPTER M

FABRICATION AND ERECTION

M1. SHOP AND ERECTION DRAWINGS

Supplementary information relevant to shop drawing documentation and associated fabrication, erection and inspection practices may be found in the *Code of Standard Practice for Steel Buildings and Bridges* (AISC, 2010a) and in Schuster (1997).

M2. FABRICATION

1. Cambering, Curving and Straightening

In addition to mechanical means, local application of heat is permitted for curving, cambering and straightening. Maximum temperatures are specified to avoid metallurgical damage and inadvertent alteration of mechanical properties. For ASTM A514/A514M and A852/A852M steels, the maximum is 1,100 °F (590 °C). For other steels, the maximum is 1,200 °F (650 °C). In general, these should not be viewed as absolute maximums; they include an allowance for a variation of about 100 °F (38 °C), which is a common range achieved by experienced fabricators (FHWA, 1999).

Temperatures should be measured by appropriate means, such as temperature-indicating crayons and steel color. Precise temperature measurements are seldom called for. Also, surface temperature measurements should not be made immediately after removing the heating torch because it takes a few seconds for the heat to soak into the steel.

Local application of heat has long been used as a means of straightening or cambering beams and girders. With this method, selected zones are rapidly heated and tend to expand. But the expansion is resisted by the restraint provided by the surrounding unheated areas. Thus, the heated areas are “upset” (increase in thickness) and, upon cooling, they shorten to effect a change in curvature. In the case of trusses and girders, cambering can be built in during assembly of the component parts.

Although the desired curvature or camber can be obtained by these various methods, including at room temperature (cold cambering) (Bjorhovde, 2006), it must be realized that some deviation due to workmanship considerations, as well as some permanent change due to handling, is inevitable. Camber is usually defined by one mid-ordinate, because control of more than one point is difficult and not normally needed. Reverse cambers are difficult to achieve and are discouraged. Long cantilevers are sensitive to camber and may deserve closer control.

2. Thermal Cutting

Thermal cutting is preferably done by machine. The requirement in ASTM A6/A6M for a positive preheat of 150 °F (66 °C) minimum when beam copes and weld access

holes are thermally cut in hot-rolled shapes with a flange thickness exceeding 2 in. (50 mm) and in built-up shapes made of material more than 2 in. (50 mm) thick tends to minimize the hard surface layer and the initiation of cracks. This requirement for preheat for thermal cutting does not apply when the radius portion of the access hole or cope is drilled and the thermally cut portion is essentially linear. Such thermally cut surfaces are required to be ground and inspected in accordance with Section J1.6.

4. **Welded Construction**

To avoid weld contamination, the light oil coating that is generally present after manufacturing an HSS should be removed with a suitable solvent in locations where welding will be performed. In cases where an external coating has been applied at the mill, the coating should be removed at the location of welding or the manufacturer should be consulted regarding the suitability of welding in the presence of the coating.

5. **Bolted Construction**

In most connections made with high-strength bolts, it is only required to install the bolts to the snug-tight condition. This includes bearing-type connections where slip is permitted and, for ASTM A325 or A325M bolts only, tension (or combined shear and tension) applications where loosening or fatigue due to vibration or load fluctuations are not design considerations.

It is suggested that snug-tight bearing-type connections with ASTM A325 or A325M or ASTM A490 or A490M bolts be used in applications where ASTM A307 bolts are permitted.

This section provides rules for the use of oversized and slotted holes paralleling the provisions that have been in the RCSC *Specification for High-Strength Bolts* since 1972 (RCSC, 2009), extended to include ASTM A307 bolts, which are outside the scope of the RCSC *Specification*.

The Specification previously limited the methods used to form holes, based on common practice and equipment capabilities. Fabrication methods have changed and will continue to do so. To reflect these changes, this Specification has been revised to define acceptable quality instead of specifying the method used to form the holes, and specifically to permit thermally cut holes. AWS C4.1, Sample 3, is useful as an indication of the thermally cut profile that is acceptable (AWS, 1977). The use of numerically controlled or mechanically guided equipment is anticipated for the forming of thermally cut holes. To the extent that the previous limits may have related to safe operation in the fabrication shop, fabricators are referred to equipment manufacturers for equipment and tool operating limits.

10. **Drain Holes**

Because the interior of an HSS is difficult to inspect, concern is sometimes expressed regarding internal corrosion. However, good design practice can eliminate the concern and the need for expensive protection.

Corrosion occurs in the presence of oxygen and water. In an enclosed building, it is improbable that there would be sufficient reintroduction of moisture to cause severe corrosion. Therefore, internal corrosion protection is a consideration only in HSS that are exposed to weather.

In a sealed HSS, internal corrosion cannot progress beyond the point where the oxygen or moisture necessary for chemical oxidation is consumed (AISI, 1970). The oxidation depth is insignificant when the corrosion process must stop, even when a corrosive atmosphere exists at the time of sealing. If fine openings exist at connections, moisture and air can enter the HSS through capillary action or by aspiration due to the partial vacuum that is created if the HSS is cooled rapidly (Blodgett, 1967). This can be prevented by providing pressure-equalizing holes in locations that make it impossible for water to flow into the HSS by gravity.

Situations where an internal protective coating may be required include: (1) open HSS where changes in the air volume by ventilation or direct flow of water is possible; and (2) open HSS subject to a temperature gradient that causes condensation. In such instances it may also be prudent to use a minimum $5/16$ in. (8 mm) wall thickness.

HSS that are filled or partially filled with concrete should not be sealed. In the event of fire, water in the concrete will vaporize and may create pressure sufficient to burst a sealed HSS. Care should be taken to ensure that water does not remain in the HSS during or after construction, since the expansion caused by freezing can create pressure that is sufficient to burst an HSS.

Galvanized HSS assemblies should not be completely sealed because rapid pressure changes during the galvanizing process tend to burst sealed assemblies.

11. Requirements for Galvanized Members

Cracking has been observed in steel members during hot-dip galvanizing. The occurrence of these cracks has been correlated to several characteristics including, but not limited to, highly restrained details, base material chemistry, galvanizing practices, and fabrication workmanship. The requirement to grind beam copes before galvanizing will not prevent all cope cracks from occurring during galvanizing. However, it has been shown to be an effective means to reduce the occurrence of this phenomenon.

Galvanizing of structural steel and hardware such as fasteners is a process that depends on special design, detailing and fabrication to achieve the desired level of corrosion protection. ASTM publishes a number of standards relating to galvanized structural steel:

ASTM A123 (ASTM, 2009e) provides a standard for the galvanized coating and its measurement and includes provisions for the materials and fabrication of the products to be galvanized.

ASTM A153/153M (ASTM, 2009a) is a standard for galvanized hardware such as fasteners that are to be centrifuged.

ASTM A384/384M (ASTM, 2007a) is the *Standard Practice for Safeguarding Against Warpage and Distortion During Hot-Dip Galvanizing of Steel Assemblies*. It includes information on factors that contribute to warpage and distortion as well as suggestions for correction for fabricated assemblies.

ASTM A385/385M (ASTM, 2009b) is the *Standard Practice for Providing High Quality Zinc Coatings (Hot-Dip)*. It includes information on base materials, venting, treatment of contacting surfaces, and cleaning. Many of these provisions should be indicated on the design and detail drawings.

ASTM A780/A780M (ASTM, 2009c) provides for repair of damaged and uncoated areas of hot-dip galvanized coatings.

M3. SHOP PAINTING

1. General Requirements

The surface condition of unpainted steel framing of long-standing buildings that have been demolished has been found to be unchanged from the time of its erection, except at isolated spots where leakage may have occurred. Even in the presence of leakage, the shop coat is of minor influence (Bigos et al., 1954).

This Specification does not define the type of paint to be used when a shop coat is required. Final exposure and individual preference with regard to finish paint are factors that determine the selection of a proper primer. A comprehensive treatment of the subject is found in various SSPC publications.

3. Contact Surfaces

Special concerns regarding contact surfaces of HSS should be considered. As a result of manufacturing, a light oil coating is generally present on the outer surface of the HSS. If paint is specified, HSS must be cleaned of this oil coating with a suitable solvent.

5. Surfaces Adjacent to Field Welds

This Specification allows for welding through surface materials, including appropriate shop coatings that do not adversely affect weld quality nor create objectionable fumes.

M4. ERECTION

2. Stability and Connections

For information on the design of temporary lateral support systems and components for low-rise buildings, see Fisher and West (1997).

4. Fit of Column Compression Joints and Base Plates

Tests on spliced full-size columns with joints that had been intentionally milled out-of-square, relative to either strong or weak axis, demonstrated that the load-carrying capacity was the same as that for similar columns without splices (Popov and

Stephen, 1977). In the tests, gaps of $1/16$ in. (2 mm) were not shimmed; gaps of $1/4$ in. (6 mm) were shimmed with nontapered mild steel shims. Minimum size partial-joint-penetration groove welds were used in all tests. No tests were performed on specimens with gaps greater than $1/4$ in. (6 mm).

5. Field Welding

The Specification incorporates AWS D1.1/D1.1M (AWS, 2010) by reference. Surface preparation requirements are defined in that code. The erector is responsible for repair of routine damage and corrosion occurring after fabrication. Welding on coated surfaces demands consideration of quality and safety. Wire brushing has been shown to result in adequate quality welds in many cases. Erector weld procedures accommodate project site conditions within the range of variables normally used on structural steel welding. Welds to material in contact with concrete and welded assemblies in which shrinkage may add up to a substantial dimensional variance may be improved by judicious selection of weld procedure variables and fit up. These conditions are dependent on other variables such as the condition and content of the concrete and the design details of the welded joint. The range of variables permitted in the class of weld procedures considered to be prequalified in the process used by the erector is the range normally used.

CHAPTER N

QUALITY CONTROL AND QUALITY ASSURANCE

N1. SCOPE

Chapter N of the 2010 AISC Specification provides minimum requirements for quality control (QC), quality assurance (QA) and nondestructive testing (NDT) for structural steel systems and steel elements of composite members for buildings and other structures. Minimum observation and inspection tasks deemed necessary to ensure quality structural steel construction are defined.

Chapter N defines a comprehensive system of “Quality Control” requirements on the part of the steel fabricator and erector and similar requirements for “Quality Assurance” on the part of the project owner’s representatives when such is deemed necessary to complement the contractor’s quality control function. These requirements exemplify recognized principles of developing involvement of all levels of management and the workforce in the quality control process as the most effective method of achieving quality in the constructed product. Chapter N supplements these quality control requirements with quality assurance responsibilities as are deemed suitable for a specific task. The Chapter N requirements follow the same requirements for inspections utilized in the AISC Specification referenced *Structural Welding Code—Steel* (AWS, 2010), hereafter referred to as AWS D1.1/D1.1M, and the *RCSC Specification for Structural Joints Using High-Strength Bolts* (RCSC, 2009), hereafter referred to as the *RCSC Specification*.

Under Section 8 of the AISC *Code of Standard Practice for Steel Buildings and Bridges* (AISC, 2010a), hereafter referred to as the *Code of Standard Practice*, the fabricator or erector is to implement a QC system as part of their normal operations. Those that participate in AISC Quality Certification or similar programs are required to develop QC systems as part of those programs. The engineer of record should evaluate what is already a part of the fabricator’s or erector’s QC system in determining the quality assurance needs for each project. Where the fabricator’s or erector’s QC system is considered adequate for the project, including compliance with any specific project needs, the special inspection or quality assurance plan may be modified to reflect this. Similarly, where additional needs are identified, supplementary requirements should be specified.

The terminology adopted for use in Chapter N is intended to provide a clear distinction of fabricator and erector requirements and the requirements of others. The definitions of QC and QA used here are consistent with usage in related industries such as the steel bridge industry and they are used for the purposes of this Specification. It is recognized that these definitions are not the only definitions in use. For example, QC and QA are defined differently in the AISC Quality

Certification program in a fashion that is useful to that program and are consistent with the International Standards Organization (ISO) and the American Society for Quality (ASQ).

For the purposes of this Specification, quality control includes those tasks performed by the steel fabricator and erector that have an effect on quality or are performed to measure or confirm quality. Quality assurance tasks performed by organizations other than the steel fabricator and erector are intended to provide a level of assurance that the product meets the project requirements.

The terms quality control and quality assurance are used throughout this Chapter to describe inspection tasks required to be performed by the steel fabricator and erector and project owner's representatives respectively. The quality assurance tasks are inspections often performed when required by the applicable building code (ABC) or authority having jurisdiction (AHJ), and designated as "Special Inspections," or as otherwise required by the project owner or engineer of record.

Chapter N defines two inspection levels for required inspection tasks and labels them as either "observe" or "perform." This is in contrast to common building code terminology which use or have used the terms "periodic" or "continuous." The reason for this change in terminology reflects the multi-task nature of welding and high-strength bolting operations, and the required inspections during each specific phase. The 2009 *International Building Code* (IBC) (ICC, 2009) requirements for special inspection of structural steel refer in very general terms to "inspection of welding" and "inspection of high-strength bolting." However, welding and high-strength bolting operations are each comprised of multiple tasks. The IBC does not specifically define what the scope of these inspections is to entail during any particular phase of those operations. Instead, Table 1704.3 in the 2009 IBC references AWS D1.1/D1.1M for weld inspections, and the 2005 AISC *Specification for Structural Steel Buildings* (AISC, 2005a) Section M2.5 for high-strength bolting inspection. These referenced documents do provide requirements pertaining to specific inspection tasks.

N2. FABRICATOR AND ERECTOR QUALITY CONTROL PROGRAM

Many quality requirements are common from project to project. Many of the processes used to produce structural steel have an effect on quality and are fundamental and integral to the fabricator's or erector's success. Consistency in imposing quality requirements between projects facilitates more efficient procedures for both.

The construction documents referred to in this Chapter are, of necessity, the versions of the design drawings, specifications, and approved shop and erection drawings that have been released for construction, as defined in the *Code of Standard Practice*. When responses to requests for information (RFI) and change orders exist that modify the construction documents, these also are part of the construction documents. When a building information model is used on the project, it also is a part of the construction documents.

Elements of a quality control program can include a variety of documentation such as policies, internal qualification requirements, and methods of tracking production

progress. Any procedure that is not apparent subsequent to the performance of the work should be considered important enough to be part of the written procedures. Any documents and procedures made available to the quality assurance inspector (QAI) should be considered proprietary and not distributed inappropriately.

The inspection documentation should include the following information:

- (1) The product inspected
- (2) The inspection that was conducted
- (3) The name of the inspector and the time period within which the inspection was conducted
- (4) Nonconformances and corrections implemented

Records can include marks on pieces, notes on drawings, process paperwork, or electronic files. A record showing adherence to a sampling plan for pre-welding compliance during a given time period may be sufficient for pre-welding observation inspection.

The level of detail recorded should result in confidence that the product is in compliance with the requirements.

N3. FABRICATOR AND ERECTOR DOCUMENTS

1. Submittals for Steel Construction

The documents listed must be submitted so that the engineer of record (EOR) or the EOR's designee can evaluate that the items prepared by the fabricator or erector meet the EOR's design intent. This is usually done through the submittal of shop and erection drawings. In many cases digital building models are produced in order to develop drawings for fabrication and erection. In lieu of submitting shop and erection drawings, the digital building model can be submitted and reviewed by the EOR for compliance with the design intent. For additional information concerning this process, refer to the *Code of Standard Practice* Appendix A, Digital Building Product Models.

2. Available Documents for Steel Construction

The documents listed must be available for review by the EOR. Certain items are of a nature that submittal of substantial volumes of documentation is not practical, and therefore it is acceptable to have these documents reviewed at the fabricator's or erector's facility by the engineer or designee, such as the QA agency. Additional commentary on some of the documentation listed in this section follows:

- (4) This section requires documentation to be available for the fastening of deck. For deck fasteners, such as screws and power fasteners, catalog cuts and/or manufacturers installation instructions are to be available for review. There is no requirement for certification of any deck fastening products.
- (8) Because the selection and proper use of welding filler metals is critical to achieving the necessary levels of strength, notch toughness, and quality, the availability for review of welding filler metal documentation and welding procedure specifications (WPSs) is required. This allows a thorough review on the part of the

- engineer, and allows the engineer to have outside consultants review these documents, if needed.
- (11) The fabricator and erector maintain written records of welding personnel qualification testing. Such records should contain information regarding date of testing, process, WPS, test plate, position, and the results of the testing. In order to verify the six-month limitation on welder qualification, the fabricator and erector should also maintain a record documenting the dates that each welder has used a particular welding process.
 - (12) The fabricator should consider *Code of Standard Practice* Section 6.1, in establishing material control procedures for structural steel.

N4. INSPECTION AND NONDESTRUCTIVE TESTING PERSONNEL

1. Quality Control Inspector Qualifications

The fabricator or erector determines the qualifications, training and experience required for personnel conducting the specified inspections. Qualifications should be based on the actual work to be performed and should be incorporated into the fabricator's or erector's QC program. Inspection of welding should be performed by an individual who, by training and/or experience in metals fabrication, inspection and testing, is competent to perform inspection of the work. This is in compliance with AWS D1.1/D1.1M subclause 6.1.4. Recognized certification programs are a method of demonstrating some qualifications but they are not the only method nor are they required by Chapter N for quality control inspectors (QCI).

2. Quality Assurance Inspector Qualifications

The quality assurance agency determines the qualifications, training and experience required for personnel conducting the specified QA inspections. This may be based on the actual work to be performed on any particular project. AWS D1.1/D1.1M subclause 6.1.4.1(3) states "An individual who, by training or experience, or both, in metals fabrication, inspection and testing, is competent to perform inspection of the work." Qualification for the QA inspector may include experience, knowledge and physical requirements. These qualification requirements are documented in the QA agency's written practice. AWS B5.1 (AWS, 2003) is a resource for qualifications of a welding inspector.

The use of associate welding inspectors under direct supervision is as permitted in AWS D1.1/D1.1M subclause 6.1.4.3.

3. NDT Personnel Qualifications

NDT personnel should have sufficient education, training and experience in those NDT methods they will perform. ASNT SNT-TC-1a (ASNT, 2006a) and ASNT CP-189 (ASNT, 2006b) prescribe visual acuity testing, topical outlines for training, written knowledge, hands-on skills examinations, and experience levels for the NDT methods and levels of qualification.

As an example, under the provisions of ASNT SNT-TC-1a, an NDT Level II individual should be qualified to set up and calibrate equipment and to interpret and evaluate results with respect to applicable codes, standards and specifications. The

NDT Level II individual should be thoroughly familiar with the scope and limitations of the methods for which they are qualified and should exercise assigned responsibility for on-the-job training and guidance of trainees and NDT Level I personnel. The NDT Level II individual should be able to organize and report the results of NDT tests.

N5. MINIMUM REQUIREMENTS FOR INSPECTION OF STRUCTURAL STEEL BUILDINGS

1. Quality Control

The welding inspection tasks listed in Tables N5.4-1 through N5.4-3 are inspection items contained in AWS D1.1/D1.1M, but have been organized in the tables in a more rational manner for scheduling and implementation using categories of before welding, during welding and after welding. Similarly, the bolting inspection tasks listed in Tables N5.6-1 through N5.6-3 are inspection items contained in the RCSC *Specification*, but have been organized in a similar manner for scheduling and implementation using traditional categories of before bolting, during bolting and after bolting. The details of each table are discussed in Commentary Sections N5.4 and N5.6.

The 2009 *International Building Code* (IBC) (ICC, 2009) makes specific statements about inspecting to “approved construction documents” the original and revised design drawings and specifications as approved by the building official or authority having jurisdiction (AHJ). *Code of Standard Practice* Section 4.2(a), requires the transfer of information from the contract documents (design drawings and project specifications) into accurate and complete shop and erection drawings. Therefore, relevant items in the design drawings and project specifications that must be followed in fabrication and erection should be placed on the shop and erection drawings, or in typical notes issued for the project. Because of this provision, QC inspection may be performed using shop drawings and erection drawings, not the original design drawings.

The applicable referenced standards in construction documents are commonly this standard, the *Specification for Structural Steel Buildings* (ANSI/AISC 360-10), *Code of Standard Practice* (AISC 303-10) (AISC, 2010a), AWS D1.1/D1.1M (AWS, 2010), and the RCSC *Specification* (RCSC, 2009).

2. Quality Assurance

Code of Standard Practice Section 8.5.2 contains the following provisions regarding the scheduling of shop fabrication inspection: “Inspection of shop work by the Inspector shall be performed in the Fabricator’s shop to the fullest extent possible. Such inspections shall be timely, in-sequence and performed in such a manner as will not disrupt fabrication operations and will permit the repair of nonconforming work prior to any required painting while the material is still in-process in the fabrication shop.”

Similarly, *Code of Standard Practice* Section 8.5.3 states “Inspection of field work shall be promptly completed without delaying the progress or correction of the work.”

Code of Standard Practice Section 8.5.1 states that, “The Fabricator and the Erector shall provide the Inspector with access to all places where the work is being performed. A minimum of 24 hours notification shall be given prior to the commencement of work.” However, the inspector’s timely inspections are necessary for this to be achieved, while the scaffolding, lifts or other means provided by the fabricator or erector for their personnel are still in place or are readily available.

IBC Table 1703.3 item 3 requires material verification of structural steel, including identification markings to conform to the 2005 AISC *Specification for Structural Steel Buildings* (ANSI/AISC 360-05) (AISC, 2005a) Section M5.5 and manufacturers’ certified mill (material) test reports. Additionally, the IBC Section 2203.1 states “Identification of structural steel members shall comply with the requirements contained in AISC 360-05. ... Steel that is not readily identifiable as to grade from marking and test records shall be tested to determine conformity to such standards.”

The 2005 AISC *Specification for Structural Steel Buildings* Section M5.5 states: “Identification of Steel. The fabricator shall be able to demonstrate by a written procedure and by actual practice a method of material identification, visible at least through the ‘fit-up’ operation, for the main structural elements of each shipping piece.” *Code of Standard Practice* Section 6.1.1 contains similar language, with more detailed options.

Code of Standard Practice Section 8.2 states “Material test reports shall constitute sufficient evidence that the mill product satisfies material order requirements. The Fabricator shall make a visual inspection of material that is received from the mill, ...” *Code of Standard Practice*, Sections 5.2 and 6.1, address the traceability of material test reports to individual pieces of steel, and the identification requirements for structural steel in the fabrication stage.

The IBC makes specific statements about inspecting to “approved construction documents,” and the original and revised design drawings and specifications as approved by the building official or the authority having jurisdiction (AHJ). Because of these IBC provisions, the QAI should inspect using the original and revised design drawings and project specifications. The QAI may also use the shop drawings and erection drawings to assist in the inspection process.

3. Coordinated Inspection

Coordination of inspection tasks may be needed for fabricators in remote locations or distant from the project itself, or for erectors with projects in locations, where inspection by a local firm or individual may not be feasible or where tasks are redundant.

The approval of both the AHJ and EOR is required for quality assurance to rely upon quality control, so there must be a level of assurance provided by the quality activi-

ties that are accepted. It may also serve as an intermediate step short of waiving quality assurance as described in Section N7.

4. Inspection of Welding

AWS D1.1/D1.1M requires inspection, and any inspection task should be done by the fabricator or erector (termed contractor within AWS D1.1/D1.1M) under the terms of subclause 6.1.2.1, as follows:

Contractor’s Inspection. This type of inspection and test shall be performed as necessary prior to assembly, during assembly, during welding, and after welding to ensure that materials and workmanship meet the requirements of the contract documents. Fabrication/erection inspection and testing shall be the responsibility of the Contractor unless otherwise provided in the contract documents.

This is further clarified in subclause 6.1.3.3, which states:

Inspector(s). When the term inspector is used without further qualification as to the specific inspector category described above, it applies equally to inspection and verification within the limits of responsibility described in 6.1.2.

The basis of Tables N5.4-1, N5.4-2 and N5.4-3 are inspection tasks, quality requirements, and related detailed items contained within AWS D1.1/D1.1M. Commentary Tables C-N5.4-1, C-N5.4-2 and C-N5.4-3 provide specific references to subclauses in AWS D1.1/D1.1M: 2010. In the determination of the task lists, and whether the task is designated “observe” or “perform,” the pertinent terms of the following AWS D1.1/D1.1M clauses were used:

6.5 Inspection of Work and Records

6.5.1 Size, Length, and Location of Welds. The Inspector shall ensure that the size, length, and location of all welds conform to the requirements of this code and to the detail drawings and that no unspecified welds have been added without the approval of the Engineer.

6.5.2 Scope of Examinations. The Inspector shall, at suitable intervals, observe joint preparation, assembly practice, the welding techniques, and performance of each welder, welding operator, and tack welder to ensure that the applicable requirements of this code are met.

6.5.3 Extent of Examination. The Inspector shall examine the work to ensure that it meets the requirements of this code. ... Size and contour of welds shall be measured with suitable gages. ...

C-6.5 Inspection of Work and Records. Except for final visual inspection, which is required for every weld, the Inspector shall inspect the work at suitable intervals to ensure that the requirements of the applicable sections of the code are met. Such inspections, on a sampling basis, shall be prior to assembly, during assembly, and during welding. ...

TABLE C-N5.4-1
Inspection Tasks Prior to Welding

Inspection Tasks Prior to Welding	AWS D1.1/D1.1M References*
Welding procedure specifications (WPSs) available	6.3
Manufacturer certifications for welding consumables available	6.2
Material identification (type/grade)	6.2
Welder identification system	6.4 (welder qualification) (identification system not required by AWS D1.1/D1.1M)
Fit-up of groove welds (including joint geometry) <ul style="list-style-type: none"> • Joint preparation • Dimensions (alignment, root opening, root face, bevel) • Cleanliness (condition of steel surfaces) • Tacking (tack weld quality and location) • Backing type and fit (if applicable) 	6.5.2 5.22 5.15 5.18 5.10, 5.22.1.1
Configuration and finish of access holes	6.5.2, 5.17 (also see Section J1.6)
Fit-up of fillet welds <ul style="list-style-type: none"> • Dimensions (alignment, gaps at root) • Cleanliness (condition of steel surfaces) • Tacking (tack weld quality and location) 	5.22.1 5.15 5.18
Check welding equipment	6.2, 5.11
*AWS (2010)	

Observe tasks are as described in subclauses 6.5.2 and 6.5.3. Subclause 6.5.2 uses the term observe and also defines the frequency to be “at suitable intervals.” The Commentary to subclause 6.5.2 further explains that “a sampling basis” is appropriate. Perform tasks are required for each weld by AWS D1.1/D1.1M, as stated in subclause 6.5.1 or 6.5.3, or are necessary for final acceptance of the weld or item. The use of the term perform is based upon the use in AWS D1.1/D1.1M of the phrases “shall examine the work” and “size and contour of welds shall be measured,” hence perform items are limited to those functions typically performed at the completion of each weld.

The words “all welds” in subclause 6.5.1 clearly indicate that all welds are required to be inspected for size, length and location in order to ensure conformity. Chapter N follows the same principle in labeling these tasks perform, which is defined as “Perform these tasks for each welded joint or member.”

TABLE C-N5.4-2
Inspection Tasks During Welding

Inspection Tasks During Welding	AWS D1.1/D1.1M References*
Use of qualified welders	6.4
Control and handling of welding consumables <ul style="list-style-type: none"> • Packaging • Exposure control 	6.2 5.3.1 5.3.2 (for SMAW), 5.3.3 (for SAW)
No welding over cracked tack welds	5.18
Environmental conditions <ul style="list-style-type: none"> • Wind speed within limits • Precipitation and temperature 	5.12.1 5.12.2
WPS followed <ul style="list-style-type: none"> • Settings on welding equipment • Travel speed • Selected welding materials • Shielding gas type/flow rate • Preheat applied • Interpass temperature maintained (min/max.) • Proper position (F, V, H, OH) 	6.3.3, 6.5.2, 5.5, 5.21 5.6, 5.7
Welding techniques <ul style="list-style-type: none"> • Interpass and final cleaning • Each pass within profile limitations • Each pass meets quality requirements 	6.5.2, 6.5.3, 5.24 5.30.1
*AWS (2010)	

The words “suitable intervals” used in subclause 6.5.2 characterize that it is not necessary to inspect these tasks for each weld, but as necessary to ensure that the applicable requirements of AWS D1.1/D1.1M are met. Following the same principles and terminology, Chapter N labels these tasks as “observe,” which is defined as “Observe these items on a random basis.”

The selection of suitable intervals as used in AWS D1.1/D1.1M subclause 6.5.2, or a suitable “sampling basis” as used in subclause C-6.5, is not defined within AWS D1.1/D1.1M, nor is it defined within the IBC or the Specification, other than the AWS statement “to ensure that the applicable requirements of this code are met.” The establishment of “at suitable intervals” and an appropriate “sampling basis” is dependent upon the quality control program of the fabricator or erector, the skills and knowledge of the welders themselves, the type of weld, and the importance of the weld. During the initial stages of a project, it may be advisable to have increased levels of observation to establish the effectiveness of the fabricator’s or erector’s quality control program, but such increased levels need not be maintained for the duration of the project, nor to the extent of inspectors being on site. Rather, an appropriate level of observation intervals can be used which is commensurate with the observed

TABLE C-N5.4-3
Inspection Tasks After Welding

Inspection Tasks After Welding	AWS D1.1/D1.1M References**
Welds cleaned	5.30.1
Size, length and location of welds	6.5.1
Welds meet visual acceptance criteria <ul style="list-style-type: none"> • Crack prohibition • Weld/base-metal fusion • Crater cross section • Weld profiles • Weld size • Undercut • Porosity 	6.5.3 Table 6.1(1) Table 6.1(2) Table 6.1(3) Table 6.1(4), 5.24 Table 6.1(6) Table 6.1(7) Table 6.1(8)
Arc strikes	5.29
<i>k</i> -area*	not addressed in AWS
Backing removed and weld tabs removed (if required)	5.10, 5.31
Repair activities	6.5.3, 5.26
Document acceptance or rejection of welded joint or member	6.5.4, 6.5.5
* <i>k</i> -area issues were identified in AISC (1997b). See Commentary Section A3.1c and Section J10.8.	
** AWS (2010)	

performance of the contractor and their personnel. More inspection may be warranted for weld fit-up and monitoring of welding operations for CJP and PJP groove welds loaded in transverse tension, compared to the time spent on groove welds loaded in compression or shear, or time spent on fillet welds. More time may be warranted observing welding operations for multi-pass fillet welds, where poor quality root passes and poor fit-up may be obscured by subsequent weld beads, when compared to single pass fillet welds.

The terms perform and observe are not to be confused with periodic and continuous used in the 2009 IBC. Both sets of terms establish two levels of inspection. The IBC terms specify whether the inspector is present at all times or not during the course of the work. Chapter N establishes inspection levels for specific tasks within each major inspection area. Perform indicates each item is to be inspected and observe indicates samples of the work are to be inspected. It is likely that the number of inspection tasks will determine whether an inspector has to be present full time but it is not in accordance with Chapter N to let the time an inspector is on site determine how many inspection tasks are done.

AWS D1.1/D1.1M subclause 6.3 states that the contractor's (fabricator/erector) inspector is specifically responsible for the WPS, verification of prequalification or proper qualification, and performance in compliance with the WPS. Quality assur-

ance inspectors monitor welding to make sure QC is effective. For this reason, Tables N5.4-1 and N5.4-2 maintain an inspection task for the QA for these functions. For welding to be performed, and for this inspection work to be done, the WPS must be available to both welder and inspector.

IBC Table 1704.3 item 4 requires material verification of weld filler materials. This is accomplished by observing that the consumable markings correspond to those in the WPS and that certificates of compliance are available for consumables used.

The footnote to Table N5.4-1 states that “The fabricator or erector, as applicable, shall maintain a system by which a welder who has welded a joint or member can be identified. Stamps, if used, shall be the low-stress type.” AWS D1.1/D1.1M does not require a welding personnel identification system. However, the inspector must verify the qualifications of welders, including identifying those welders whose work “appears to be below the requirements of this code.” Also, if welds are to receive nondestructive testing (NDT), it is essential to have a welding personnel identification system to (a) reduce the rate of NDT for good welders, and (2) increase the rate of NDT for welders whose welds frequently fail NDT. This welder identification system can also benefit the contractor by clearly identifying welders who may need additional training.

The proper fit-up for groove welds and fillet welds prior to welding should first be checked by the fitter and/or welder. Such detailed dimensions should be provided on the shop or erection drawings, as well as included in the WPS. Fitters and welders must be equipped with the necessary measurement tools to ensure proper fit-up prior to welding.

AWS D1.1/D1.1M subclause 6.2 on Inspection of Materials and Equipment states that, “The Contractor’s Inspector shall ensure that only materials and equipment conforming to the requirements of this code shall be used.” For this reason, the check of welding equipment is assigned to QC only, and is not required for QA.

5. Nondestructive Testing of Welded Joints

5a. Procedures

Buildings are subjected to static loading, unless fatigue is specifically addressed as prescribed in Appendix 3. Specification Section J2 provisions contain exceptions to AWS D1.1/D1.1M.

5b. CJP Groove Weld NDT

For statically loaded structures, AWS D1.1/D1.1M and the Specification have no specific nondestructive testing (NDT) requirements, leaving it to the engineer to determine the appropriate NDT method(s), locations or categories of welds to be tested, and the frequency and type of testing (full, partial or spot), in accordance with AWS D1.1/D1.1M subclause 6.15.

TABLE C-N5.4-4
Descriptions of Risk Categories for
Buildings and Other Structures from
ASCE/SEI 7*

Risk Category I
Buildings and other structures that represent a low risk to human life in the event of failure
Risk Category II
All buildings and other structures except those listed in Risk Categories I, III and IV
Risk Category III
Buildings and other structures, the failure of which could pose a substantial risk to human life
Buildings and other structures, not included in Risk Category IV, with potential to cause a substantial economic impact and/or mass disruption of day-to-day civilian life in the event of failure
Buildings and other structures not included in Risk Category IV (including, but not limited to, facilities that manufacture, process, handle, store, use, or dispose of such substances as hazardous fuels, hazardous chemicals, hazardous waste, or explosives) containing toxic or explosive substances where their quantity exceeds a threshold quantity established by the authority having jurisdiction and is sufficient to pose a threat to the public if released.
Risk Category IV
Buildings and other structures designated as essential facilities
Buildings and other structures, the failure of which could pose a substantial hazard to the community.
Buildings and other structures (including, but not limited to, facilities that manufacture, process, handle, store, use, or dispose of such substances as hazardous fuels, hazardous chemicals, or hazardous waste) containing sufficient quantities of highly toxic substances where the quantity exceeds a threshold quantity established by the authority having jurisdiction to be dangerous to the public if released and is sufficient to pose a threat to the public if released.
Buildings and other structures required to maintain the functionality of other Risk Category IV structures
*ASCE (2010)

The Specification implements a selection of NDT methods and a rate of ultrasonic testing (UT) based upon a rational system of risk of failure. ASCE *Minimum Design Loads for Buildings and Other Structures*, (ASCE/SEI 7-10), (ASCE, 2010) provides a recognized system of assigning risk to various types of structures.

Complete-joint-penetration (CJP) groove welds loaded in tension applied transversely to their axis are assumed to develop the capacity of the smaller steel element being joined, and therefore have the highest demand for quality. CJP groove welds in compression or shear are not subjected to the same crack propagation risks as welds subjected to tension. Partial-joint-penetration (PJP) groove welds are designed using a limited design strength when in tension, based upon the root condition, and therefore are not subjected to the same high stresses and subsequent crack propagation risk as a CJP groove weld. PJP groove welds in compression or shear are similarly at substantially less risk of crack propagation than CJP groove welds.

Fillet welds are designed using limited strengths, similar to PJP groove welds, and are designed for shear stresses regardless of load application, and therefore do not warrant NDT.

The selection of joint type and thickness ranges for ultrasonic testing (UT) are based upon AWS D1.1/D1.1M subclause 6.20.1, which limits the procedures and standards as stated in Part F of AWS D1.1/D1.1M to groove welds and heat affected zones (HAZ) between the thicknesses of $\frac{5}{16}$ in. and 8 in. (8 mm and 200 mm), inclusive.

ASCE/SEI 7-10, Table 1.5-1, provides four risk categories for buildings and other structures. Commentary Table C-N5.4-4, taken from Table 1-1 (ASCE/SEI 7-10), describes the various risk categories in general terms. The example structures are drawn from the 2005 ASCE *Minimum Design Loads for Buildings and Other Structures* (ASCE, 2005b), which used the term “occupancy category” for a similar purpose, and provided prescriptive definitions of building types and occupancies.

5c. Access Hole NDT

The web-to-flange intersection and the web center of heavy hot-rolled shapes, as well as the interior portions of heavy plates, may contain a coarser grain structure and/or lower notch toughness than other areas of these products. Grinding to bright metal is required by Section M2.2 to remove the hard surface layer, and testing using magnetic particle or dye penetrate methods is performed to assure smooth transitions free of notches or cracks.

5d. Welded Joints Subjected to Fatigue

CJP groove welds in butt joints so designated in Specification Table A-3.1, Sections 5 and 6.1, require that internal soundness be verified using ultrasonic testing (UT) or radiographic testing (RT), meeting the acceptance requirements of AWS D1.1/D1.1M (AWS, 2010) subclause 6.12 or 6.13, as appropriate.

5e. Reduction of Rate of Ultrasonic Testing

For statically loaded structures in Risk Categories III and IV, reduction of the rate of UT from 100% is permitted for individual welders who have demonstrated a high

level of skill, proven after a significant number of their welds have been tested. This provision has been adapted from similar provisions used in the Uniform Building Code (ICBO, 1997) for UT inspection of CJP groove welds in moment frames in areas of high seismic risk.

5f. Increase in Rate of Ultrasonic Testing

For Risk Category II, where 10% of CJP groove welds loaded in transverse tension are tested, an increase in the rate of UT is required for individual welders who have failed to demonstrate a high level of skill, established as a failure rate of more than 5%, after a sufficient number of their welds have been tested. To implement this effectively, and not necessitate the retesting of welds previously deposited by a welder who has a high reject rate established after the 20 welds have been tested, it is suggested that at the start of the work, a higher rate of UT be performed on each welder's completed welds.

6. Inspection of High-Strength Bolting

The 2009 IBC, similar to Section M2.5 of the Specification, incorporates the RCSC *Specification* (RCSC, 2009) by reference. The RCSC *Specification*, like the referenced welding standard, defines bolting inspection requirements in terms of inspection tasks and scope of examinations. The RCSC *Specification* uses the term “routine observation” for the inspection of all pretensioned bolts, further validating the choice of the term “observe” in this chapter of the Specification.

Snug-tightened joints are required to be inspected to ensure that the proper fastener components are used and that the faying surfaces are brought into firm contact during installation of the bolts. The magnitude of the clamping force that exists in a snug-tightened joint is not a consideration and need not be verified.

Pretensioned joints and slip-critical joints are required to be inspected to ensure that the proper fastener components are used and that the faying surfaces are brought into firm contact during the initial installation of the bolts. Pre-installation verification testing is required for all pretensioned bolt installations, and the nature and scope of installation verification will vary based on the installation method used. The following provisions from the RCSC *Specification* serve as the basis for Tables N5.6-1, N5.6-2 and N5.6-3 (underlining added for emphasis of terms):

9.2.1. Turn-of-Nut Pretensioning: The inspector shall observe the pre-installation verification testing required in Section 8.2.1. Subsequently, it shall be insured by routine observation that the bolting crew properly rotates the turned element relative to the unturned element by the amount specified in Table 8.2. Alternatively, when fastener assemblies are match-marked after the initial fit-up of the joint, but prior to pretensioning; visual inspection after pretensioning is permitted in lieu of routine observation.

9.2.2. Calibrated Wrench Pretensioning: The *inspector* shall observe the pre-installation verification testing required in Section 8.2.2. Subsequently, it shall be ensured by routine observation that the bolting crew properly applies the calibrated wrench to the turned element. No further evidence of conformity is required.

9.2.3. Twist-Off-Type Tension Control Bolt Pretensioning: The inspector shall observe the pre-installation verification testing required in Section 8.2.3. Subsequently, it shall be ensured by routine observation that the splined ends are properly severed during installation by the bolting crew.

9.2.4. Direct-Tension Indicator Pretensioning: The inspector shall observe the pre-installation verification testing required in Section 8.2.4. Subsequently, but prior to pretensioning, it shall be ensured by routine observation that the appropriate feeler gage is accepted in at least half of the spaces between the protrusions of the direct tension indicator and that the protrusions are properly oriented away from the work.

2009 IBC Table 1704.3 item 1 requires material verification of high-strength bolts, nuts and washers, including manufacturer's certificates of compliance, and verification of the identification markings to conform to the ASTM fastener standards specified in the approved construction documents.

2009 IBC Section 1704.3.3 contains extensive discussion of the requirements for bolting inspection, including verifying fastener components, bolted parts and installation. It includes observation of the fabricator's or erector's pre-installation verification test, and observation of the calibration of wrenches if the calibrated wrench method is being used. It requires verification that the snug-tight condition has been achieved for all joints, and monitoring of installation to verify the proper use of the installation procedure by the bolting crew for pretensioned bolts. The presence of the inspector is dependent upon whether the installation method provides visual evidence of completed installation. Turn-of-nut installation with matchmarking, installation using twist-off bolts, and installation using direct tension indicators provides visual evidence of a completed installation, and therefore "periodic" special inspection is permitted for these methods. Turn-of-nut installation without matchmarking and calibrated wrench installation provides no such visual evidence, and therefore "continuous" special inspection is required, such that the inspector needs to be onsite, although not necessarily watching every bolt or joint as it is being pretensioned.

The concepts of 2009 IBC, as stated above, serve as the basis of the bolting inspection requirements of Section N5.6, along with the provisions of the RCSC *Specification*. In lieu of "continuous" inspection as defined by the IBC, Chapter N uses the term "shall be engaged" to indicate a higher level of observation for these methods.

The inspection provisions of the RCSC *Specification* rely upon observation of the work, hence all tables use Observe for the designated tasks. Commentary Tables C-N5.6-1, C-N5.6-2 and C-N5.6-3 provide the applicable RCSC *Specification* references for inspection tasks prior to, during and after bolting.

7. Other Inspection Tasks

2009 IBC Section 1704A.3.2 requires that the steel frame be inspected to verify compliance with the details shown on the approved construction documents, such as bracing, stiffening, member locations and proper application of joint details at each connection. This is repeated in 2009 IBC Table 1704.3 item 6.

TABLE C-N5.6-1
Inspection Tasks Prior to Bolting

Inspection Tasks Prior to Bolting	Applicable RCSC <i>Specification</i> References*
Manufacturer's certifications available for fastener materials	2.1, 9.1
Fasteners marked in accordance with ASTM requirements	Figure C-2.1, 9.1 (also see ASTM standards)
Proper fasteners selected for the joint detail (grade, type, bolt length if threads to be excluded from shear plane)	2.3.2, 2.7.2, 9.1
Proper bolting procedure selected for joint detail	4, 8
Connecting elements, including the appropriate faying surface condition and hole preparation, if specified, meet applicable requirements	3, 9.1, 9.3
Pre-installation verification testing by installation personnel observed and documented for fastener assemblies and methods used	7, 9.2
Proper storage provided for bolts, nuts, washers, and other fastener components	2.2, 8, 9.1
*RCSC (2009)	

TABLE C-N5.6-2
Inspection Tasks During Bolting

Inspection Tasks During Bolting	Applicable RCSC <i>Specification</i> References*
Fastener assemblies, of suitable condition, placed in all holes and washers (if required) are positioned as required	8.1, 9.1
Joint brought to the snug tight condition prior to the pretensioning operation	8.1, 9.1
Fastener component not turned by the wrench prevented from rotating	8.2, 9.2
Fasteners are pretensioned in accordance with a method approved by RCSC and progressing systematically from most rigid point toward free edges	8.2, 9.2
*RCSC (2009)	

TABLE C-N5.6-3 Inspection Tasks After Bolting

Inspection Tasks After Bolting	Applicable RCSC <i>Specification</i> References*
Document acceptance or rejection of bolted connections	not addressed by RCSC
*RCSC (2009)	

2009 IBC Section 2204.2.1 on anchor rods for steel requires that they be set accurately to the pattern and dimensions called for on the plans. In addition, it is required that the protrusion of the threaded ends through the connected material be sufficient to fully engage the threads of the nuts, but not be greater than the length of the threads on the bolts.

Code of Standard Practice, Section 7.5.1, states that anchor rods, foundation bolts, and other embedded items are to be set by the owner's designated representative for construction. The erector is likely not on site to verify placement, therefore it is assigned solely to the quality assurance inspector (QAI). Because it is not possible to verify proper anchor rod materials and embedment following installation, it is required that the QAI be onsite when the anchor rods are being set.

N6. MINIMUM REQUIREMENTS FOR INSPECTION OF COMPOSITE CONSTRUCTION

This section addresses the inspection of only those elements of composite construction that are structural steel or are frequently within the scope of the fabricator and/or erector (steel deck and field-installed shear stud connectors). The inspection requirements for the other elements of composite construction, such as concrete, formwork, reinforcement, and the related dimensional tolerances, are addressed elsewhere. Three publications of the American Concrete Institute may be applicable. These are *Specifications for Tolerances for Concrete Construction and Commentary* (ACI 117-06) (ACI, 2006), *Specifications for Structural Concrete* (ACI 301-05) (ACI, 2005), and *Building Code Requirements for Structural Concrete and Commentary* (ACI 318-08) (ACI, 2008).

N7. APPROVED FABRICATORS AND ERECTORS

The 2009 IBC Section 1704.2.2 (ICC, 2009) states that:

Special inspections required by this code are not required where the work is done on the premises of a fabricator registered and approved to perform such work without special inspection.

Approval shall be based upon review of the fabricator's written procedural and quality control manuals and periodic auditing of fabrication practices by an approved special inspection agency.

An example of how these approvals may be made by the building official or authority having jurisdiction (AHJ) is the use of the AISC Certification program. A fabricator certified to the AISC Certification Program for Structural Steel Fabricators, *Standard for Steel Building Structures* (AISC, 2006b), meets the criteria of having a quality control manual, written procedures, and annual onsite audits conducted by AISC's independent auditing company, Quality Management Company, LLC. Similarly, steel erectors may be an AISC Certified Erector or AISC Advanced Certified Steel Erector. The audits confirm that the company has the personnel, knowledge, organization, equipment, experience, capability, procedures and commitment to produce the required quality of work for a given certification category.

APPENDIX 1

DESIGN BY INELASTIC ANALYSIS

Appendix 1 contains provisions for the inelastic analysis and design of structural steel systems, including continuous beams, moment frames, braced frames and combined systems. The Appendix has been modified from the previous Specification to allow for the use of a wider range of inelastic analysis methods, varying from the traditional plastic design approaches to the more advanced nonlinear finite element analysis methods. In several ways, this Appendix represents a logical extension of the direct analysis method of Chapter C, in which second-order elastic analysis is used. The provision for moment redistribution in continuous beams, which is permitted for elastic analysis only, is provided in Section B3.7.

The provisions of this Appendix permit the use of analysis methods that are more sophisticated than those required by Chapter C. The provisions also permit the use of computational analysis (e.g., the finite element method) to replace the Specification equations used to evaluate limit states covered by Chapters D through K. The application of these provisions requires a complete understanding of the provisions of this Appendix as well as the equations they supersede. It is the responsibility of any engineer using these provisions to fully verify the completeness and accuracy of analysis software used for this purpose.

1.1. GENERAL REQUIREMENTS

These requirements directly parallel the general requirements of Chapter C and are further discussed in Commentary Section C1.

Various levels of inelastic analysis are available to the designer (Ziemian, 2010; Chen and Toma, 1994). All are intended to account for the potential redistribution of member and connection forces and moments that are a result of localized yielding as a structural system reaches a strength limit state. At the higher levels they have the ability to model complex forms of nonlinear behavior and detect member and/or frame instabilities well before the formation of a plastic mechanism. Many of the strength design equations used in the Specification for members subject to compression, flexure and combinations thereof were developed using refined methods of inelastic analysis; along with experimental results and engineering judgment (Yura et al., 1978; Kanchanalai and Lu, 1979; Bjorhovde, 1988; Ziemian, 2010). Also, research over the past twenty years has yielded significant advances in procedures for the direct application of second-order inelastic analysis in design (Ziemian, et al., 1992; White and Chen, 1993; Liew, et al., 1993; Ziemian and Miller, 1997; Chen and Kim, 1997). Correspondingly, there has been a steady increase in the inclusion of provisions for inelastic analysis in commercial steel design software, but the level varies widely. Use of any analysis software requires an understanding of the aspects of structural behavior it simulates, the quality of its methods, and whether or not the software's ductility and analysis provisions are equivalent to those of Sections 1.2

and 1.3. There are numerous studies available for verifying the accuracy of the inelastic analysis (Kanchanlai, 1977, El-Zanaty et al., 1980; White and Chen, 1993; Surovek-Maleck and White, 2003; Martinez-Garcia and Ziemian, 2006; Ziemian, 2010).

With this background, it is the intent of this Appendix to allow certain levels of inelastic analysis to be used in place of the Specification design equations as a basis for confirming the adequacy of a member or system. In all cases, the strength limit state behavior being addressed by the corresponding provisions of the Specification needs to be considered. For example, Section E3 provides equations that define the nominal compressive strength corresponding to the flexural buckling of members without slender elements. The strengths determined by these equations account for many factors, which primarily include the initial out-of-straightness of the compression member, *residual stresses* that result from the fabrication process, and the reduction of flexural stiffness due to second-order effects and partial yielding of the cross section. If these factors are directly incorporated within the inelastic analysis and a comparable or higher level of reliability can be assured, then the specific strength equations of Section E3 need not be evaluated. In other words, the inelastic analysis will indicate the limit state of flexural buckling and the design can be evaluated accordingly. On the other hand, suppose that the same inelastic analysis is not capable of modeling flexural-torsional buckling. In this case, the provisions of Section E4 would need to be evaluated. Other examples of strength limit states not detected by the analysis may include, but are not limited to, lateral-torsional buckling strength of flexural members, connection strength, and shear yielding or buckling strengths.

Item 5 in the second paragraph of Section 1.1, General Requirements, states that "...uncertainty in system, member, and connection strength and stiffness..." shall be taken into account. Member and connection reliability requirements are fulfilled by the probabilistically derived resistance factors and load factors of load and resistance factor design of this Specification. System reliability considerations at this time (2010) are still a project-by-project exercise, and no overall methods have as yet been developed for steel building structures. Introduction to the topic of system reliability can be found in textbooks, for example, Ang and Tang (1984), Thoft-Christensen and Murotsu (1986), and Nowak and Collins (2000), as well as in many publications, for example, Buonopane and Schafer (2006).

Because this type of analysis is inherently conducted at ultimate load levels, the provisions of this Appendix are limited to the design basis of Section B3.3 (LRFD).

Per Section B3.9, the serviceability of the design should be assessed with specific requirements given in Chapter L. In satisfying these requirements in conjunction with a design method based on inelastic analysis, consideration should be given to the degree of steel yielding permitted at service loads. Of particular concern are: (a) permanent deflections that may occur due to steel yielding, and (b) stiffness degradation due to yielding and whether this is modeled in the inelastic analysis.

Although the use of inelastic analysis has great potential in earthquake engineering, the specific provisions beyond the general requirements of this Appendix do not apply to seismic design. The two primary reasons for this are:

- (1) In defining “equivalent” static loads for use in elastic seismic design procedures, a significant level of yielding and inelastic force redistribution has been assumed and hence, it would not be appropriate to use these loads with a design approach based on inelastic analysis.
- (2) The ductility requirements for seismic design based on inelastic analysis are more stringent than those provided in this Specification for nonseismic loads.

Guidelines for the use of inelastic analysis and design for seismic applications are provided in Chapter 16 of the *Minimum Design Loads for Buildings and Other Structures* (ASCE/SEI 7-10) (ASCE, 2010) and *Seismic Rehabilitation of Existing Buildings* (ASCE/SEI 41-06) (ASCE, 2006).

Connections adjacent to plastic hinges must be designed with sufficient strength and ductility to sustain the forces and deformations imposed under the required loads. The practical implementation of this rule is that the applicable requirements of Section B3.6 and Chapter J must be strictly adhered to. These provisions for connection design have been developed from plasticity theory and verified by extensive testing, as discussed in ASCE (1971) and in many books and papers. Thus the connections that meet these provisions are inherently qualified for use in designing structures based on inelastic analysis.

Any method of design that is based on inelastic analysis and satisfies the given general requirements is permitted. These methods may include the use of nonlinear finite element analyses (Crisfield, 1991; Bathe, 1995) that are based on continuum elements to design a single structural component such as a connection, or the use of second-order inelastic frame analyses (Clarke et al., 1992; McGuire et al., 2000) to design a structural system consisting of beams, columns and connections.

Sections 1.2 and 1.3 collectively define provisions that can be used to satisfy the ductility and analysis requirements of Section 1.1. They provide the basis for an approved second-order inelastic frame analysis method. These provisions are not intended to preclude other approaches meeting the requirements of Section 1.1.

1.2. DUCTILITY REQUIREMENTS

Because an inelastic analysis will provide for the redistribution of internal forces due to yielding of structural components such as members and connections, it is imperative that these components have adequate ductility and be capable of maintaining their design strength while accommodating inelastic deformation demands. Factors that affect the inelastic deformation capacity of components include the material properties, the slenderness of cross-sectional elements, and the unbraced length. There are two general methods for assuring adequate ductility: (1) limiting the aforementioned factors, and (2) making direct comparisons of the actual inelastic deformation demands with predefined values of inelastic deformation capacities. The former is provided in Appendix 1. It essentially decouples inelastic local buckling from inelastic lateral-torsional buckling. It has been part of the plastic design provisions for several previous editions of the Specification. Examples of the latter approach in which ductility demands are compared with defined capacities appear in

Galambos (1968b), Kato (1990), Kemp (1996), Gioncu and Petcu (1997), FEMA-350 (FEMA, 2000), ASCE 41-06 (ASCE, 2006), and Ziemian (2010).

1. Material

Extensive past research on the plastic and inelastic behavior of continuous beams, *rigid frames* and connections has amply demonstrated the suitability of steel with yield stress levels up to 65 ksi (450 MPa) (ASCE, 1971).

2. Cross Section

Design by inelastic analysis requires that, up to the peak of the load-deflection curve of the structure, the moments at the plastic hinge locations remain at the level of the plastic moment, which itself should be reduced for the presence of axial force. This implies that the member must have sufficient inelastic rotation capacity to permit the redistribution of additional moments. Sections that are designated as compact in Section B4 have a minimum rotation capacity of approximately $R_{cap} = 3$ (see Figure C-A-1.1) and are suitable for developing plastic hinges. The limiting width-to-thickness ratio designated as λ_p in Table B4.1b and designated as λ_{pd} in this Appendix is the maximum slenderness ratio that will permit this rotation capacity to be achieved. Further discussion of the antecedents of these provisions is given in the Commentary Section B4.

The additional slenderness limits in Equations A-1-1 through A-1-4 apply to cases not covered in Table B4.1b. Equations A-1-1 and A-1-2, which define height-to-thickness ratio limits of webs of wide-flange members and rectangular HSS under combined flexure and compression, have been part of the plastic design requirements since the 1969 Specification and are based on research documented in *Plastic Design in Steel, A Guide and a Commentary* (ASCE, 1971). The equations for the flanges of HSS and other boxed sections (Equation A-1-3) and for circular HSS (Equation A-1-4) are from the *Specification for the Design of Steel Hollow Structural Sections* (AISC, 2000a).

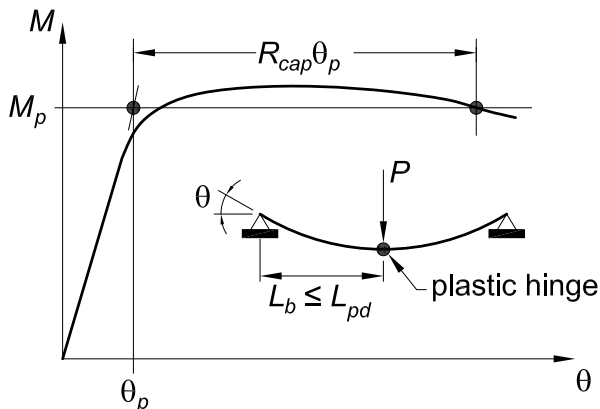

Fig. C-A-1.1. Definition of rotation capacity.

Limiting the slenderness of elements in a cross section to ensure ductility at plastic hinge locations is permissible only for doubly symmetric shapes. In general, single-angle, tee and double-angle sections are not permitted for use in plastic design because the inelastic rotation capacity in the regions where the moment produces compression in an outstanding leg will typically not be sufficient.

3. Unbraced Length

The ductility of structural members with plastic hinges can be significantly reduced by the possibility of inelastic lateral-torsional buckling. In order to provide adequate rotation capacity, such members may need more closely spaced bracing than would be otherwise needed for design in accordance with elastic theory. Equations A-1-5 and A-1-7 define the maximum permitted unbraced length in the vicinity of plastic hinges for wide-flange shapes bent about their major axis, and for rectangular shapes and symmetric box beams, respectively. These equations are a modified version of those appearing in the 2005 AISC Specification (AISC, 2005a), which were based on research reported by Yura et al. (1978). The intent of these equations is to ensure a minimum rotation capacity, $R_{cap} \geq 3$, where R_{cap} is defined as shown in Figure C-A-1.1.

Equations A-1-5 and A-1-7 have been modified to account for nonlinear moment diagrams and for situations in which a plastic hinge does not develop at the brace location corresponding to the larger end moment. The moment M_2 in these equations is the larger moment at the end of the unbraced length, taken as positive in all cases. The moment M_1' is the moment at the opposite end of the unbraced length corresponding to an equivalent linear moment diagram that gives the same target rotation capacity. This equivalent linear moment diagram is defined as follows:

- (a) For cases in which the magnitude of the bending moment at any location within the unbraced length, M_{max} , exceeds M_2 , the equivalent linear moment diagram is taken as a constant (uniform) moment diagram with a value equal to M_{max} [see Figure C-A-1.2(a)]. Since the equivalent moment diagram is uniform, the appropriate value for L_{pd} can be obtained by using $M_1'/M_2 = +1$.
- (b) For cases in which the internal moment distribution along the unbraced length of the beam is indeed linear, or when a linear moment diagram between M_2 and the actual moment, M_1 , at the opposite end of the unbraced length gives a larger magnitude moment in the vicinity of M_2 [see Figure C-A-1.2(b)], M_1' is taken equal to the actual moment M_1 .
- (c) For all other cases in which the internal moment distribution along the unbraced length of the beam is nonlinear and a linear moment diagram between M_2 and the actual moment, M_1 , underestimates the moment in the vicinity of M_2 , M_1' is defined as the opposite end moment for a line drawn between M_2 and the moment at the middle of the unbraced length, M_{mid} [see Figure C-A-1.2(c)].

The moments M_1 and M_{mid} are individually taken as positive when they cause compression in the same flange as the moment M_2 and negative otherwise.

For conditions in which lateral-torsional buckling cannot occur, such as members with square and round cross sections and members of doubly symmetric shapes

subjected to minor axis bending or sufficient tension, the ductility of the member is not a factor of the unbraced length.

4. Axial Force

The provision in this section restricts the axial force in a compression member to $0.75F_yA_g$ or approximately 80% of the design yield load, $\phi_c F_y A$. This provision is a cautionary limitation because insufficient research has been conducted to ensure that sufficient inelastic rotation capacity remains in members subject to high levels of axial force.

1.3. ANALYSIS REQUIREMENTS

For all structural systems with members subject to axial force, the equations of equilibrium must be formulated on the geometry of the deformed structure. The use of second-order inelastic analysis to determine load effects on members and connections is discussed in the *Guide to Stability Design Criteria for Metal Structures* (Ziemian, 2010). Textbooks [for example, Chen and Lui (1991), Chen and Sohal (1995), and McGuire et al. (2000)] present basic approaches to inelastic analysis, as well as worked examples and computer software for detailed study of the subject.

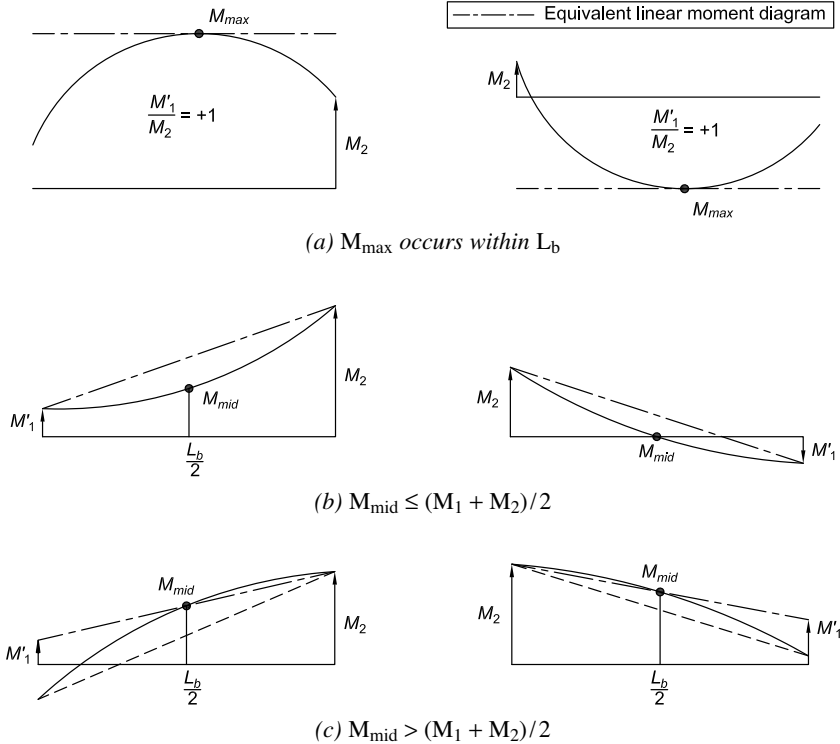

Fig. C-A-1.2. Equivalent linear moment diagram used to calculate M_1' .

Continuous, braced beams not subject to axial loads can be designed by first-order inelastic analysis (traditional plastic analysis and design). *First-order plastic analysis* is treated in ASCE (1971), in steel design textbooks [for example, Salmon et al. (2008)], and in textbooks dedicated entirely to plastic design [for example, Beedle (1958), Horne and Morris (1982), Bruneau et al. (1998), and Wong (2009)]. Tools for plastic analysis of continuous beams are readily available to the designer from these and other books that provide simple ways of calculating plastic mechanism loads. It is important to note that such methods use LRFD load combinations, either directly or implicitly, and therefore should be modified to include a reduction in the plastic moment capacity of all members by a factor of 0.9. First-order inelastic analysis may also be used in the design of continuous steel-concrete composite beams. Design limits and ductility criteria for both the positive and negative plastic moments are given by Oehlers and Bradford (1995).

1. Material Properties and Yield Criteria

This section provides an accepted method for including uncertainty in system, member, and connection strength and stiffness. The reduction in yield strength and member stiffness is equivalent to the reduction of member strength associated with the AISC resistance factors used in elastic design. In particular, the factor of 0.90 is based on the member and component resistance factors of Chapters E and F, which are appropriate when the structural system is composed of a single member and in cases where the system resistance depends critically on the resistance of a single member. For systems where this is not the case, the use of such a factor is conservative. The reduction in stiffness will contribute to larger deformations and in turn, increased second-order effects.

The inelastic behavior of most structural members is primarily the result of normal stresses in the direction of the longitudinal axis of the member equaling the yield strength of the material. Therefore the normal stresses produced by the axial force and major and minor axis bending moments should be included in defining the plastic strength of member cross sections (Chen and Atsuta, 1976).

Modeling of *strain hardening* that results in strengths greater than the plastic strength of the cross section is not permitted.

2. Geometric Imperfections

Because initial geometric imperfections may affect the nonlinear behavior of a structural system, it is imperative that they be included in the second-order analysis. Discussion on how frame out-of-plumbness may be modeled is provided in Commentary Section C2.2. Additional information is provided in ECCS (1984), Bridge and Bizzanelli (1997), Bridge (1998), and Ziemian (2010).

Member out-of-straightness should be included in situations in which it can have a significant impact on the inelastic behavior of the structural system. The significance of such effects is a function of (1) the relative magnitude of the member's applied axial force and bending moments, (2) whether the member is subject to single or reverse curvature bending, and (3) the slenderness of the member.

In all cases, initial geometric imperfections should be modeled to represent the potential maximum destabilizing effects.

3. Residual Stresses and Partial Yielding Effects

Depending on the ratio of a member's plastic section modulus, Z , to its elastic section modulus, S , the partial yielding that occurs before the formation of a plastic hinge may significantly reduce the flexural stiffness of the member. This is particularly the case for minor axis bending of I-shapes. Any change to bending stiffness may result in force redistribution and increased second-order effects, and thus needs to be considered in the inelastic analysis.

The impact of partial yielding is further accentuated by the presence of thermal residual stresses, which are due to nonuniform cooling during the manufacturing and fabrication processes. Because the relative magnitude and distribution of these stresses is dependent on the process and the member's cross-section geometry, it is not possible to specify a single idealized pattern for use in all levels of inelastic analysis. Residual stress distributions used for common hot-rolled doubly symmetric shapes are provided in the literature, including ECCS (1984) and Ziemian (2010). In most cases, the maximum compressive residual stress is 30% to 50% of the yield stress.

The effects of partial yielding and residual stresses may either be included directly in inelastic distributed-plasticity analyses or by modifying plastic hinge based methods of analysis. An example of the latter is provided by Ziemian and McGuire (2002) and Ziemian et al. (2008), in which the flexural stiffness of members are reduced according to the amount of axial force and major and minor axis bending moments being resisted. The Specification permits the use of a similar strategy, which is provided in Section C2.3 and described in the Commentary to that section. If the residual stress effect is not included in the analysis and the provisions of Section C2.3 are employed, the stiffness reduction factor of 0.9 specified in Section 1.3.1 (which accounts for uncertainty in strength and stiffness) must be changed to 0.8. The reason for this is that the equations given in Section C2.3 assume that the analysis does not account for partial yielding. Also, to avoid cases in which the use of Section C2.3 may be unconservative, it is further required that the yield or plastic hinge criterion used in the inelastic analysis be defined by the interaction Equations H1-1a and H1-1b. This condition on cross section strength does not have to be met when the residual stress and partial yielding effects are accounted for in the analysis.

APPENDIX 2

DESIGN FOR PONDING

Ponding stability is determined by ascertaining that the conditions of Equations A-2-1 and A-2-2 of Appendix 2 are fulfilled. These equations provide a conservative evaluation of the stiffness required to avoid runaway deflection, giving a safety factor of four against ponding instability.

Since Equations A-2-1 and A-2-2 yield conservative results, it may be advantageous to perform a more detailed stress analysis to check whether a roof system that does not meet the above equations is still safe against ponding failure.

For the purposes of Appendix 2, *secondary members* are the beams or joists that directly support the distributed ponding loads on the roof of the structure, and *primary members* are the beams or girders that support the concentrated reactions from the secondary members framing into them. Representing the deflected shape of the primary and critical secondary member as a half-sine wave, the weight and distribution of the ponded water can be estimated, and, from this, the contribution that the deflection of each of these members makes to the total ponding deflection can be expressed as follows (Marino, 1966):

For the primary member

$$\Delta_w = \frac{\alpha_p \Delta_o [1 + 0.25\pi\alpha_s + 0.25\pi\rho(1 + \alpha_s)]}{1 - 0.25\pi\alpha_p\alpha_s} \quad (\text{C-A-2-1})$$

For the secondary member

$$\delta_w = \frac{\alpha_s \delta_o \left[1 + \frac{\pi^3}{32}\alpha_p + \frac{\pi^2}{8\rho}(1 + \alpha_p) + 0.185\alpha_s\alpha_p \right]}{1 - 0.25\pi\alpha_p\alpha_s} \quad (\text{C-A-2-2})$$

In these expressions Δ_o and δ_o are, respectively, the primary and secondary beam deflections due to loading present at the initiation of ponding, and

$$\alpha_p = C_p / (1 - C_p), \quad \alpha_s = C_s / (1 - C_s), \quad \text{and} \quad \rho = \delta_o / \Delta_o = C_s / C_p$$

$$\alpha_s = C_s / (1 - C_s)$$

$$\rho = \delta_o / \Delta_o = C_s / C_p$$

Using the above expressions for Δ_w and δ_w , the ratios Δ_w/Δ_o and δ_w/δ_o can be computed for any given combination of primary and secondary beam framing using the computed values of coefficients C_p and C_s , respectively, defined in the Specification.

Even on the basis of unlimited elastic behavior, it is seen that the ponding deflections would become infinitely large unless

$$\left(\frac{C_p}{1-C_p} \right) \left(\frac{C_s}{1-C_s} \right) < \frac{4}{\pi} \quad (\text{C-A-2-3})$$

Since elastic behavior is not unlimited, the effective bending strength available in each member to resist the stress caused by ponding action is restricted to the difference between the yield stress of the member and the stress, f_o , produced by the total load supported by it before consideration of ponding is included.

Note that elastic deflection is directly proportional to stress. The admissible amount of ponding in either the primary or critical (midspan) secondary member, in terms of the applicable ratio, Δ_w/Δ_o and δ_w/δ_o , can be represented as $(0.8F_y - f_o)/f_o$, assuming a safety factor of 1.25 against yielding under the ponding load. Substituting this expression for Δ_w/Δ_o and δ_w/δ_o , and combining with the foregoing expressions for Δ_w and δ_w , the relationship between the critical values for C_p and C_s and the available elastic bending strength to resist ponding is obtained. The curves presented in Figures A-2.1 and A-2.2 are based upon this relationship. They constitute a design aid for use when a more exact determination of required flat roof framing stiffness is needed than given by the Specification provision that $C_p + 0.9C_s \leq 0.25$.

Given any combination of primary and secondary framing, the stress index is computed as follows:

For the primary member

$$U_p = \left(\frac{0.8F_y - f_o}{f_o} \right)_p \quad (\text{C-A-2-4})$$

For the secondary member

$$U_s = \left(\frac{0.8F_y - f_o}{f_o} \right)_s \quad (\text{C-A-2-5})$$

where

f_o = the stress due to $D + R$ (D = nominal dead load, R = nominal load due to rain-water or ice exclusive of the ponding contribution), ksi (MPa)

Depending upon geographic location, this loading should include such amount of snow as might also be present, although ponding failures have occurred more frequently during torrential summer rains when the rate of precipitation exceeded the rate of drainage runoff and the resulting hydraulic gradient over large roof areas caused substantial accumulation of water some distance from the eaves.

Given the size, spacing and span of a tentatively selected combination of primary and secondary beams, for example, one may enter Figure A-2.1 at the level of the computed stress index, U_p , determined for the primary beam; move horizontally to the computed C_s value of the secondary beams; then move downward to the abscissa

scale. The combined stiffness of the primary and secondary framing is sufficient to prevent ponding if the flexibility coefficient read from this latter scale is larger than the value of C_p computed for the given primary member; if not, a stiffer primary or secondary beam, or combination of both, is required.

If the roof framing consists of a series of equally spaced wall-bearing beams, the beams would be considered as secondary members, supported on an infinitely stiff primary member. For this case, one would use Figure A-2.2. The limiting value of C_s would be determined by the intercept of a horizontal line representing the U_s value and the curve for $C_p = 0$.

The ponding deflection contributed by a metal deck is usually such a small part of the total ponding deflection of a roof panel that it is sufficient merely to limit its moment of inertia to 0.000025 (3 940) times the fourth power of its span length [in.⁴ per foot (mm⁴ per meter) of width normal to its span], as provided in Equation A-2-2. However, the stability against ponding of a roof consisting of a metal roof deck of relatively slender depth-to-span ratio, spanning between beams supported directly on columns, may need to be checked. This can be done using Figures A-2.1 or A-2.2 with the following computed values:

U_p = stress index for the supporting beam

U_s = stress index for the roof deck

C_p = flexibility coefficient for the supporting beams

C_s = flexibility coefficient for 1-ft (0.305-m) width of the roof deck ($S = 1.0$)

Since the shear rigidity of the web system is less than that of a solid plate, the moment of inertia of steel joists and trusses should be taken as somewhat less than that of their chords (Heinzerling, 1987).

APPENDIX 3

DESIGN FOR FATIGUE

When the limit state of fatigue is a design consideration, its severity is most significantly affected by the number of load applications, the magnitude of the stress range, and the severity of the stress concentrations associated with particular details. Issues of fatigue are not normally encountered in building design; however, when encountered and if the severity is great enough, fatigue is of concern and all provisions of Appendix 3 must be satisfied.

3.1. GENERAL PROVISIONS

In general, members or connections subject to less than a few thousand cycles of loading will not constitute a fatigue condition except possibly for cases involving full reversal of loading and particularly sensitive categories of details. This is because the applicable cyclic allowable stress range will be limited by the static allowable stress. At low levels of cyclic tensile stress, a point is reached where the stress range is so low that fatigue cracking will not initiate regardless of the number of cycles of loading. This level of stress is defined as the *fatigue threshold*, F_{TH} .

Extensive test programs using full-size specimens, substantiated by theoretical stress analysis, have confirmed the following general conclusions (Fisher et al., 1970; Fisher et al., 1974):

- (1) Stress range and notch severity are the dominant stress variables for welded details and beams;
- (2) Other variables such as minimum stress, mean stress and maximum stress are not significant for design purposes; and
- (3) Structural steels with a specified minimum yield stress of 36 to 100 ksi (250 to 690 MPa) do not exhibit significantly different fatigue strengths for given welded details fabricated in the same manner.

3.2. CALCULATION OF MAXIMUM STRESSES AND STRESS RANGES

Fluctuation in stress that does not involve tensile stress does not cause crack propagation and is not considered to be a fatigue situation. On the other hand, in elements of members subject solely to calculated compressive stress, fatigue cracks may initiate in regions of high tensile *residual stress*. In such situations, the cracks generally do not propagate beyond the region of the residual tensile stress, because the residual stress is relieved by the crack. For this reason, stress ranges that are completely in compression need not be investigated for fatigue. For cases involving cyclic reversal of stress, the calculated stress range must be taken as the sum of the compressive stress and the tensile stress caused by different directions or patterns of the applied live load.

3.3. PLAIN MATERIAL AND WELDED JOINTS

Fatigue resistance has been derived from an exponential relationship between the number of cycles to failure, N , and the stress range, S_r , called an $S-N$ relationship, of the form

$$N = \frac{C_f}{S_r^n} \tag{C-A-3-1}$$

The general relationship is often plotted as a linear log-log function ($\text{Log } N = A - n \text{ Log } S_r$). Figure C-A-3.1 shows the family of fatigue resistance curves identified as Categories A, B, B', C, C', D, E and E'. These relationships were established based on an extensive database developed in the United States and abroad (Keating and Fisher, 1986). The allowable stress range has been developed by adjusting the coefficient, C_f , so that a design curve is provided that lies two standard deviations of the standard error of estimate of the fatigue cycle life below the mean $S-N$ relationship of the actual test data. These values of C_f correspond to a probability of failure of 2.5% of the design life.

Prior to the 1999 AISC *Load and Resistance Factor Design Specification for Structural Steel Buildings* (AISC, 2000b), stepwise tables meeting the above criteria of cycles of loading, stress categories, and allowable stress ranges were provided in the Specifications. A single table format (Table A-3.1) was introduced in the 1999 AISC LRFD Specification that provides the stress categories, ingredients for the applicable equation, and information and examples including the sites of concern for potential crack initiation (AISC, 2000b).

Table A-3.1 is organized into eight sections of general conditions for fatigue design, as follows:

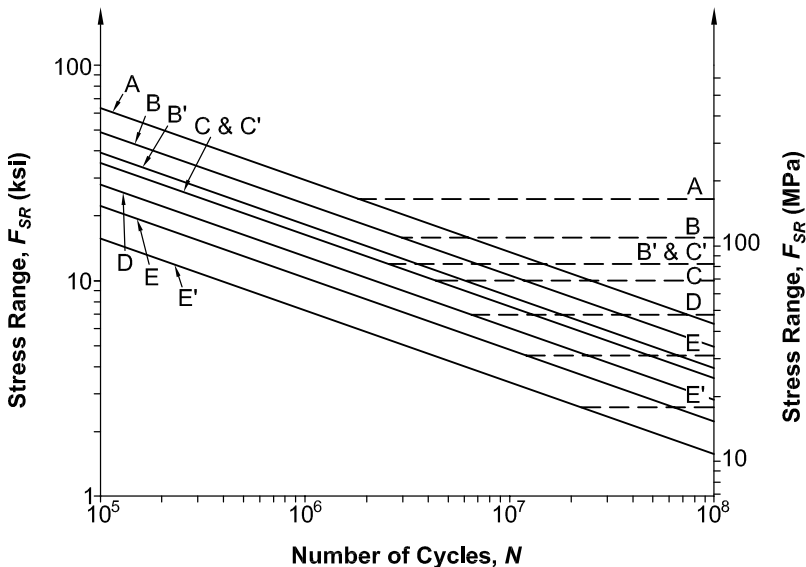

Fig. C-A-3.1. Fatigue resistance curves.

- Section 1 provides information and examples for the steel material at copes, holes, cutouts or as produced.
- Section 2 provides information and examples for various types of mechanically fastened joints including eyebars and pin plates.
- Section 3 provides information related to welded connections used to join built-up members, such as longitudinal welds, access holes and reinforcements.
- Section 4 deals only with longitudinal load carrying fillet welds at shear splices.
- Section 5 provides information for various types of groove and fillet welded joints that are transverse to the applied cyclic stress.
- Section 6 provides information on a variety of groove welded attachments to flange tips and web plates as well as similar attachments connected with either fillet or partial-joint-penetration groove welds.
- Section 7 provides information on several short attachments to structural members.
- Section 8 collects several miscellaneous details such as shear connectors, shear on the throat of fillet, plug and slot welds, and their impact on base metal. It also provides for tension on the stress area of various bolts, threaded anchor rods, and hangers.

A similar format and consistent criteria are used by other specifications.

When fabrication details involving more than one stress category occur at the same location in a member, the stress range at that location must be limited to that of the most restrictive category. The need for a member larger than required by static loading will often be eliminated by locating notch-producing fabrication details in regions subject to smaller ranges of stress.

A detail not explicitly covered before 1989 (AISC, 1989) was added in the 1999 AISC LRFD Specification to cover tension-loaded plate elements connected at their end by transverse partial-joint-penetration groove or fillet welds in which there is more than a single site for the initiation of fatigue cracking, one of which will be more critical than the others depending upon welded joint type and size and material thickness (Frank and Fisher, 1979). Regardless of the site within the joint at which potential crack initiation is considered, the allowable stress range provided is applicable to connected material at the toe of the weld.

3.4. BOLTS AND THREADED PARTS

The fatigue resistance of bolts subject to tension is predictable in the absence of pretension and prying action; provisions are given for such nonpretensioned details as hanger rods and anchor rods. In the case of pretensioned bolts, deformation of the connected parts through which pretension is applied introduces prying action, the magnitude of which is not completely predictable (Kulak et al., 1987). The effect of prying is not limited to a change in the average axial tension on the bolt but includes bending in the threaded area under the nut. Because of the uncertainties in calculating prying effects, definitive provisions for the allowable stress range for bolts subject to applied axial tension are not included in this Specification. To limit the uncertainties regarding prying action on the fatigue of pretensioned bolts in details which introduce prying, the allowable stress range provided in Table A-3.1 is appropriate for extended *cyclic loading* only if the prying induced by the applied load is small.

Nonpretensioned fasteners are not permitted under this Specification for joints subject to cyclic shear forces. Bolts installed in joints meeting all the requirements for slip-critical connections survive unharmed when subject to cyclic shear stresses sufficient to fracture the connected parts; provisions for such bolts are given in Section 2 of Table A-3.1.

3.5. SPECIAL FABRICATION AND ERECTION REQUIREMENTS

It is essential that when longitudinal backing bars are to be left in place, they be continuous or spliced using flush-ground complete-joint-penetration groove welds before attachment to the parts being joined. Otherwise, the transverse nonfused section constitutes a crack-like defect that can lead to premature fatigue failure or even *brittle fracture* of the built-up member.

In transverse joints subjected to tension a lack-of-fusion plane in T-joints acts as an initial crack-like condition. In groove welds, the root at the backing bar often has discontinuities that can reduce the fatigue resistance of the connection. Removing the backing, back gouging the joint and rewelding eliminates the undesirable discontinuities.

The addition of contoured fillet welds at transverse complete-joint-penetration groove welds in T- and corner joints and at reentrant corners reduces the stress concentration and improves fatigue resistance.

Experimental studies on welded built-up beams demonstrated that if the surface roughness of flame-cut edges was less than 1,000 $\mu\text{in.}$ (25 μm), fatigue cracks would not develop from the flame-cut edge but from the longitudinal fillet welds connecting the beam flanges to the web (Fisher et al., 1970, 1974). This provides stress category B fatigue resistance without the necessity for grinding flame-cut edges.

Reentrant corners at cuts, copes and weld access holes provide a stress concentration point that can reduce fatigue resistance if discontinuities are introduced by punching or thermal cutting. Reaming sub-punched holes and grinding the thermally cut surface to bright metal prevents any significant reduction in fatigue resistance.

The use of run-off tabs at transverse butt-joint groove welds enhances weld soundness at the ends of the joint. Subsequent removal of the tabs and grinding of the ends flush with the edge of the member removes discontinuities that are detrimental to fatigue resistance.

APPENDIX 4

STRUCTURAL DESIGN FOR FIRE CONDITIONS

4.1. GENERAL PROVISIONS

Appendix 4 provides structural engineers with criteria for designing steel-framed building systems and components, including columns, and floor and truss assemblies, for fire conditions. Additional guidance is provided in this Commentary. Compliance with the performance objective in Section 4.1.1 can be demonstrated by either structural analysis or component qualification testing.

Thermal expansion and progressive decrease in strength and stiffness are the primary structural responses to elevated temperatures that may occur during fires. An assessment of a design of building components and systems based on structural mechanics that allows designers to address the fire-induced restrained thermal expansions, deformations and material degradation at elevated temperatures can lead to a more robust structural design for fire conditions.

4.1.1. Performance Objective

The performance objective underlying the provisions in this Specification is that of life safety. Fire safety levels should depend on the building occupancy, height of the building, the presence of active fire mitigation measures, and the effectiveness of fire-fighting. Three limit states exist for elements serving as fire barriers (compartment walls and floors): (1) heat transmission leading to unacceptable rise of temperature on the unexposed surface; (2) breach of barrier due to cracking or loss of integrity; and (3) loss of load-bearing capacity. In general, all three must be considered by the engineer to achieve the desired performance. These three limit states are interrelated in fire-resistant design. For structural elements that are not part of a separating element, the governing limit state is loss of load-bearing capacity.

Specific performance objectives for a facility are determined by the stakeholders in the building process, within the context of the above general performance objective and limit states. In some instances, applicable building codes may stipulate that steel in buildings of certain occupancies and heights be protected by fire-resistant materials or assemblies to achieve specified performance goals.

4.1.2. Design by Engineering Analysis

The strength design criteria for steel beams and columns at elevated temperatures have been revised from the 2005 *Specification for Structural Steel Buildings* (AISC, 2005a) to reflect recent research (Tagaki and Deierlein, 2007). These strength equations do not transition smoothly to the strength equations used to design steel members under ambient conditions. The practical implications of the discontinuity are minor, as the temperatures in the structural members during a

fully developed fire are far in excess of the temperatures at which this discontinuity might otherwise be of concern in design. Nevertheless, to avoid the possibility of misinterpretation, the scope of applicability of the analysis methods in Section 4.2 of Appendix 4 is limited to temperatures above 400 °F (204 °C).

Structural behavior under severe fire conditions is highly nonlinear in nature as a result of the constitutive behavior of materials at elevated temperatures and the relatively large deformations that may develop in structural systems at sustained elevated temperatures. As a result of this behavior, it is difficult to develop design equations to ensure the necessary level of structural performance during severe fires using elastically based ASD methods. Accordingly, structural design for fire conditions by analysis should be performed using LRFD methods, in which the nonlinear structural actions arising during severe fire exposures and the temperature-dependent design strengths can be properly taken into account.

4.1.4. Load Combinations and Required Strength

Fire safety measures are aimed at three levels: (1) to prevent the outbreak of fires through elimination of ignition sources or hazardous practices; (2) to prevent uncontrolled fire development and flashover through early detection and suppression; and (3) to prevent loss of life or structural collapse through fire protection systems, compartmentation, exit ways, and provision of general structural integrity and other passive measures. Specific structural design provisions to check structural integrity and risk of progressive failure due to severe fires can be developed from principles of structural reliability theory (Ellingwood and Leyendecker, 1978; Ellingwood and Corotis, 1991).

The limit state probability of failure due to fire can be written as

$$P(F) = P(F|D,I) P(D|I) P(I) \quad (\text{C-A-4-1})$$

where $P(I)$ = probability of ignition, $P(D|I)$ = probability of development of a structurally significant fire, and $P(F|D,I)$ = probability of failure, given the occurrence of the two preceding events. Measures taken to reduce $P(I)$ and $P(D|I)$ are mainly nonstructural in nature. Measures taken by the structural engineer to design fire resistance into the structure impact the term $P(F|D,I)$.

The development of structural design requirements requires a target reliability level, reliability being measured by $P(F)$ in Equation C-A-4-1. Analysis of reliability of structural systems for gravity dead and live load (Galambos et al., 1982) suggests that the limit state probability of individual steel members and connections is on the order of 10^{-5} to 10^{-4} per year. For redundant steel frame systems, $P(F)$ is on the order of 10^{-6} to 10^{-5} . The *de minimis* risk, that is, the level below which the risk is of regulatory or legal concern and the economic or social benefits of risk reduction are small, is on the order of 10^{-7} to 10^{-6} per year (Pate-Cornell, 1994). If $P(I)$ is on the order of 10^{-4} per year for typical buildings and $P(D|I)$ is on the order of 10^{-2} for office or commercial buildings in urban areas with suppression systems or other protective measures, then $P(F|D,I)$ should be approximately 0.1 to ascertain that the risk due to structural failure caused by fire is socially acceptable.

The use of first-order structural reliability analysis based on this target (conditional) limit state probability leads to the gravity load combination presented as Equation A-4-1. Load combination Equation A-4-1 is similar to Equation 2.5-1 that appears in ASCE/SEI 7-10 (ASCE, 2010), where the probabilistic bases for load combinations for extraordinary events is explained in detail. The factor 0.9 is applied to the dead load when the effect of the dead load is to stabilize the structure; otherwise, the factor 1.2 is applied. The companion action load factors on L and S in that equation reflect the fact that the probability of a coincidence of the peak time-varying load with the occurrence of a fire is negligible (Ellingwood and Corotis, 1991).

The overall stability of the structural system is checked by considering the effect of a small notional lateral load equal to 0.2% of the story gravity force, as defined in Section C2.2, acting in combination with the gravity loads. The required strength of the structural component or system designed using load combination A-4-1 is on the order of 60% to 70% of the required strength under full gravity or wind load at normal temperature.

4.2. STRUCTURAL DESIGN FOR FIRE CONDITIONS BY ANALYSIS

4.2.1. Design-Basis Fire

Once a fuel load has been agreed upon for the occupancy, the designer should demonstrate the effect of various fires on the structure by assessing the temperature-time relationships for various ventilation factors. These relations may result in different structural responses, and it is useful to demonstrate the capability of the structure to withstand such exposures. The effects of a localized fire should also be assessed to ascertain that local damage is not excessive. Based on these results, connections and edge details can be specified to provide a structure that is sufficiently robust.

4.2.1.1. Localized Fire

Localized fires may occur in large open spaces, such as the pedestrian area of covered malls, concourses of airport terminals, warehouses, and factories, where fuel packages are separated by large aisles or open spaces. In such cases, the radiant heat flux can be estimated by a point source approximation, requiring the heat release rate of the fire and separation distance between the center of the fuel package and the closest surface of the steelwork. The heat release rate can be determined from experimental results or may be estimated if the mass loss rate per unit floor area occupied by the fuel is known. Otherwise, a steady-state fire may be assumed.

4.2.1.2. Post-Flashover Compartment Fires

Caution should be exercised when determining temperature-time profiles for spaces with high aspect ratios, for example, 5:1 or greater, or for large spaces; for example, those with an open (or exposed) floor area in excess of 5,000 ft² (465 m²). In such cases, it is unlikely that all combustibles will burn in the space simultaneously. Instead, burning will be most intense in, or perhaps limited to,

the combustibles nearest to a ventilation source. For modest-sized compartments with low aspect ratios, the temperature history of the design fire can be determined by algebraic equations or computer models, such as those described in the *SFPE Handbook of Fire Protection Engineering* (SFPE, 2002).

Caution should be exercised when determining the fire duration for spaces with high aspect ratios, for example, 5:1 or greater, or for large spaces, for example, those with a floor area in excess of 5,000 ft² (465 m²). The principal difficulty lies in obtaining a realistic estimate for the mass loss rate, given that all combustibles within the space may not be burning simultaneously. Failure to recognize uneven burning will result in an overestimation of the mass burning rate and an underestimation of the fire duration by a significant margin. Note: some computation methods may implicitly determine the duration of the fire, in which case the calculation of mass loss rate is unnecessary.

Where a parametric curve is used to define a post-flashover fire, the duration is determined by means of the fuel versus ventilation provisions, not explicitly by loss of mass. This clause should not limit the use of temperature-time relationships to those where duration is calculated, as stated above, as these tend to be localized fires and external fire.

4.2.1.3. Exterior Fires

A design guide is available for determining the exposure resulting from an exterior fire (AISI, 1979).

4.2.1.4. Active Fire Protection Systems

Due consideration should be given to the reliability and effectiveness of active fire protection systems when describing the design-basis fire. When an automatic sprinkler system is installed, the total fuel load may be reduced by up to 60% [Eurocode 1 (CEN, 1991)]. The maximum reduction in the fuel load should be considered only when the automatic sprinkler system is considered to be of the highest reliability; for example, reliable and adequate water supply, supervision of control valves, regular schedule for maintenance of the automatic sprinkler system developed in accordance with NFPA (2002a), or alterations of the automatic sprinkler system are considered any time alterations for the space are considered.

For spaces with automatic smoke and heat vents, computer models are available to determine the smoke temperature (SFPE, 2002). Reduction in the temperature profile as a result of smoke and heat vents should only be considered for reliable installations of smoke and heat vents. As such, a regular maintenance schedule for the vents needs to be established in accordance with NFPA (2002b).

4.2.2. Temperatures in Structural Systems under Fire Conditions

The heat transfer analysis may range from one-dimensional analyses where the steel is assumed to be at uniform temperature to three-dimensional analyses. The uniform temperature assumption is appropriate in a “lumped heat capacity analysis” where a steel column, beam or truss element is uniformly heated along the entire length and around the entire perimeter of the exposed section and the

protection system is uniform along the entire length and around the entire perimeter of the section. In cases with nonuniform heating or where different protection methods are used on different sides of the column, a one-dimensional analysis should be conducted for steel column assemblies. Two-dimensional analyses are appropriate for beams, bar joists or truss elements supporting floor or roof slabs.

Heat transfer analyses should consider changes in material properties with increasing temperature for all materials included in the assembly. This may be done in the lumped heat capacity analysis using an effective property value, determined at a temperature near the estimated mid-point of the temperature range expected to be experienced by that component over the duration of the exposure. In the one- and two-dimensional analyses, the variation in properties with temperature should be explicitly included.

The boundary conditions for the heat transfer analysis shall consider radiation heat transfer in all cases and convection heat transfer if the exposed element is submerged in the smoke or is being subjected to flame impingement. The presence of fire resistive materials in the form of insulation, heat screens, or other protective measures shall be taken into account, if appropriate.

Lumped Heat Capacity Analysis. This first-order analysis to predict the temperature rise of steel structural members can be conducted using algebraic equations iteratively. This approach assumes that the steel member has a uniform temperature, applicable to cases where the steel member is unprotected or uniformly protected (on all sides), and is exposed to fire around the entire perimeter of the assembly containing the steel member. Caution should be used when applying this method to steel beams supporting floor and roof slabs, as the approach will overestimate the temperature rise in the beam. In addition, where this analysis is used as input for the structural analysis of a fire-exposed steel beam supporting a floor and roof slab, the thermally induced moments will not be simulated as a result of the uniform temperature assumption.

Unprotected Steel Members. The temperature rise in an unprotected steel section in a short time period is determined by:

$$\Delta T_s = \frac{a}{c_s \left(\frac{W}{D} \right)} (T_F - T_s) \Delta t \quad (\text{C-A-4-2})$$

The heat transfer coefficient, a , is determined from

$$a = a_c + a_r \quad (\text{C-A-4-3})$$

where

a_c = convective heat transfer coefficient

a_r = radiative heat transfer coefficient, given as:

$$a_r = \frac{5.67 \times 10^{-8} \epsilon_F}{T_F - T_s} (T_F^4 - T_s^4) \quad (\text{C-A-4-4})$$

TABLE C-A-4.1
Guidelines for Estimating ϵ_F

Type of Assembly	ϵ_F
Column, exposed on all sides	0.7
Floor beam: Embedded in concrete floor slab, with only bottom flange of beam exposed to fire	0.5
Floor beam, with concrete slab resting on top flange of beam	
Flange width-to-beam depth ratio ≥ 0.5	0.5
Flange width-to-beam depth ratio < 0.5	0.7
Box girder and lattice girder	0.7

For the standard exposure, the convective heat transfer coefficient, a_c , can be approximated as $25 \text{ W/m}^2\text{-}^\circ\text{C}$ [$4.4 \text{ Btu}/(\text{ft}^2\text{-hr-}^\circ\text{F})$]. The parameter, ϵ_F , accounts for the emissivity of the fire and the view factor. Estimates for ϵ_F , are suggested in Table C-A-4.1.

For accuracy reasons, a maximum limit for the time step, Δt , is suggested as 5 s.

The fire temperature needs to be determined based on the results of the design fire analysis. As alternatives, the standard time-temperature curves indicated in ASTM E119 (ASTM, 2009d) for building fires or ASTM E1529 (ASTM, 2006) for petrochemical fires may be selected.

Protected Steel Members. This method is most applicable for steel members with contour protection schemes, in other words, where the insulating or (protection) material follows the shape of the section. Application of this method for box protection methods will generally result in the temperature rise being overestimated. The approach assumes that the outside insulation temperature is approximately equal to the fire temperature. Alternatively, a more complex analysis may be conducted which determines the exterior insulation temperature from a heat transfer analysis between the assembly and the exposing fire environment.

If the thermal capacity of the insulation is much less than that for the steel, such that the following inequality is satisfied:

$$c_s W/D > 2d_p \rho_p c_p \quad (\text{C-A-4-5})$$

Then, Equation C-A-4-6 can be applied to determine the temperature rise in the steel:

$$\Delta T_s = \frac{k_p}{c_s d_p \left(\frac{W}{D} \right)} (T_F - T_s) \Delta t \quad (\text{C-A-4-6})$$

If the thermal capacity of the insulation needs to be considered (such that the inequality in Equation C-A-4-5 is not satisfied), then Equation C-A-4-7 should be applied:

$$\Delta T_s = \frac{k_p}{d_p} \left[\frac{T_F - T_s}{c_s \left(\frac{W}{D} \right) + \frac{c_p \rho_p d_p}{2}} \right] \Delta t \quad (\text{C-A-4-7})$$

The maximum limit for the time step, Δt , should be 5 s.

Ideally, material properties should be considered as a function of temperature. Alternatively, material properties may be evaluated at a mid-range temperature expected for that component. For protected steel members, the material properties may be evaluated at 572 °F (300 °C), and for protection materials, a temperature of 932 °F (500 °C) may be considered.

External Steelwork. Temperature rise can be determined by applying the following equation:

$$\Delta T_s = \frac{q''}{c_s \left(\frac{W}{D} \right)} \Delta t \quad (\text{C-A-4-8})$$

where q'' is the net heat flux incident on the steel member.

Advanced Calculation Methods. The thermal response of steel members may be assessed by application of a computer model. A computer model for analyzing the thermal response of the steel members should consider the following:

- (1) Exposure conditions established based on the definition of a design fire. The exposure conditions need to be stipulated either in terms of a time-temperature history, along with radiation and convection heat transfer parameters associated with the exposure, or as an incident heat flux. The incident heat flux is dependent on the design fire scenario and the location of the structural assembly. The heat flux emitted by the fire or smoke can be determined from a fire hazard analysis. Exposure conditions are established based on the definition of a design fire. The exposure conditions are stipulated either in terms of a time-temperature history, along with radiation and convection heat transfer parameters associated with the exposure, or as an incident heat flux.
- (2) Temperature-dependent material properties.
- (3) Temperature variation within the steel member and any protection components, especially where the exposure varies from side-to-side.

Nomenclature:

D = heat perimeter, in. (m)

T = temperature, °F (°C)

W = weight (mass) per unit length, lb/ft (kg/m)

a = heat transfer coefficient, Btu/ft²-sec-°F (W/m²-°C)

- c = specific heat, Btu/lb·°F (J/kg·°C)
 d = thickness, in. (m)
 k = thermal conductivity, Btu/ft·sec·°F (W/m·°C)
 Δt = time interval, s
 ρ = density, lb/ft³ (kg/m³)

Subscripts:

- c = convection
 p = fire protection material
 r = radiation
 s = steel

4.2.3. Material Strengths at Elevated Temperatures

The properties for steel and concrete at elevated temperatures are adopted from the ECCS *Model Code on Fire Engineering* (ECCS, 2001), Section III.2, "Material Properties." These generic properties are consistent with those in Eurocode 3 (CEN, 2005) and Eurocode 4 (CEN, 2003), and reflect the consensus of the international fire engineering and research community. The background information for the mechanical properties of structural steel at elevated temperatures can be found in Cooke (1988) and Kirby and Preston (1988).

The stress-strain response of steel at elevated temperatures is more nonlinear than at room temperature and experiences less *strain hardening*. As shown in Figure C-A-4.1, at elevated temperatures the deviation from linear behavior is represented by the proportional limit, $F_p(T)$, and the yield strength, $F_y(T)$, is defined at a 2% strain. At 1,000 °F (538 °C), the yield strength, $F_y(T)$, reduces to about 66% of its value at room temperature, and the proportional limit $F_p(T)$ occurs at 29% of the elevated temperature yield strength $F_y(T)$. Finally, at

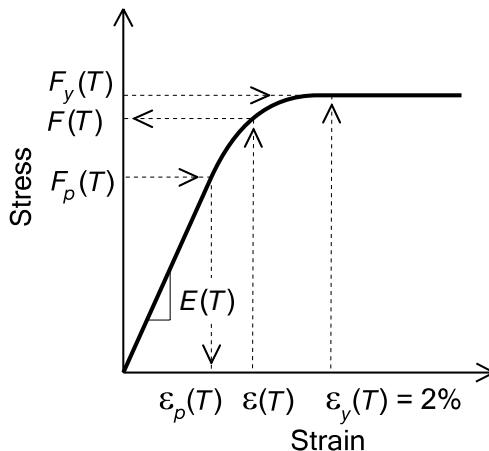

Fig. C-A-4.1. Parameters of idealized stress-strain curve at elevated temperatures (Takagi and Deierlein, 2007).

temperatures above 750 °F (399 °C), the elevated temperature ultimate strength is essentially the same as the elevated temperature yield strength; in other words, $F_y(T)$ is equal to $F_u(T)$.

4.2.4. Structural Design Requirements

The resistance of the structural system in the design basis fire may be determined by:

- (a) Structural analysis of individual elements where the effects of restraint to thermal expansion and bowing may be ignored but the reduction in strength and stiffness with increasing temperature is incorporated
- (b) Structural analysis of assemblies/subframes where the effects of restrained thermal expansion and thermal bowing are considered by incorporating geometric and material nonlinearities
- (c) Global structural analysis where restrained thermal expansion, thermal bowing, material degradation, and geometric nonlinearity are considered

4.2.4.1. General Structural Integrity

The requirement for general structural integrity is consistent with that appearing in Section 1.4 of ASCE (2010). Structural integrity is the ability of the structural system to absorb and contain local damage or failure without developing into a progressive collapse that involves the entire structure or a disproportionately large part of it.

The Commentary C1.4 to Section 1.4 of ASCE (2010) contains guidelines for the provision of general structural integrity. Compartmentation (subdivision of buildings/stories in a building) is an effective means of achieving resistance to progressive collapse as well as preventing fire spread, as a cellular arrangement of structural components that are well tied together provides stability and integrity to the structural system as well as insulation.

4.2.4.2. Strength Requirements and Deformation Limits

As structural elements are heated, their expansion is restrained by adjacent elements and connections. Material properties degrade with increasing temperature. Load transfer can occur from hotter elements to adjacent cooler elements. Excessive deformation may be of benefit in a fire as it allows release of thermally induced stresses. Deformation is acceptable once horizontal and vertical separation as well as the overall load bearing capacity of the structural system is maintained.

4.2.4.3. Methods of Analysis

4.2.4.3a. Advanced Methods of Analysis

Advanced methods are required when the overall structural system response to fire, the interaction between structural members and separating elements in fire, or the residual strength of the structural system following a fire must be considered.

4.2.4.3b. Simple Methods of Analysis

Simple methods may suffice when a structural member or component can be assumed to be subjected to uniform heat flux on all sides and the assumption of a uniform temperature is reasonable as, for example, in a free-standing column.

In the 2005 Specification, nominal member strengths at elevated temperatures were calculated using the standard strength equations of the Specification with steel properties (E , F_y and F_u) reduced for elevated temperatures by appropriate factors. Recent research (Takagi and Deierlein, 2007) has shown this procedure to over-estimate considerably the strengths of members that are sensitive to stability effects. To reduce these unconservative errors, new equations, developed by Takagi and Deierlein (2007) are introduced in the 2010 edition of the Specification to more accurately calculate the strength of compression members subjected to flexural buckling and flexural members subjected to lateral-torsional buckling. As shown in Figure C-A-4.2, the 2010 Specification equations are much more accurate in comparison to detailed finite element method analyses (represented by the square symbol in the figure), which have been validated against test data, and to equations from the Eurocode (ECCS, 2001).

4.2.4.4. Design Strength

The design strength for structural steel members and connections is calculated as ϕR_n , in which R_n = nominal strength, when the deterioration in strength at elevated temperature is taken into account, and ϕ is the resistance factor. The nominal strength is computed as in Chapters C through K and Appendix 4 of the Specification, using material strength and stiffnesses at elevated temperatures defined in Tables A-4.2.1 and A-4.2.2. While ECCS (2001) and Eurocode 1 (CEN, 1991) specify partial material factors as equal to 1.0 for “accidental” limit states, the uncertainties in strength at elevated temperatures are substantial and in some cases are unknown. Accordingly, the resistance factors herein are the same as those at ordinary conditions.

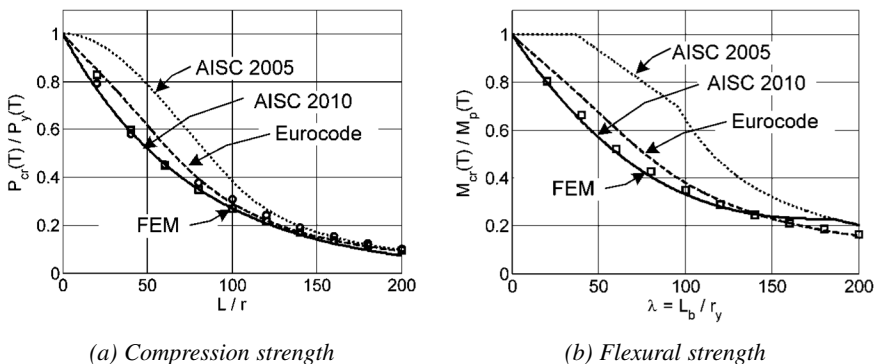

Fig. C-A-4.2 Comparison of compression and flexural strengths at 500 °C (932 °F) (Takagi and Deierlein, 2007).

4.3. DESIGN BY QUALIFICATION TESTING

4.3.1. Qualification Standards

Qualification testing is an acceptable alternative to design by analysis for providing fire resistance. Fire resistance ratings of building elements are generally determined in accordance with procedures set forth in ASTM E119, *Standard Test Methods for Fire Tests of Building Construction and Materials* (ASTM, 2009d). Tested building element designs, with their respective fire resistance ratings, may be found in special directories and reports published by testing agencies. Additionally, calculation procedures based on standard test results may be used as specified in *Standard Calculation Methods for Structural Fire Protection* (ASCE, 2005a).

For building elements that are required to prevent the spread of fire, such as walls, floors and roofs, the test standard provides for measurement of the transmission of heat. For loadbearing building elements, such as columns, beams, floors, roofs and loadbearing walls, the test standard also provides for measurement of the load-carrying ability under the standard fire exposure.

For beam, floor and roof specimens tested under ASTM E119, two fire resistance classifications—restrained and unrestrained—may be determined, depending on the conditions of restraint and the acceptance criteria applied to the specimen.

4.3.2. Restrained Construction

The ASTM E119 standard provides for tests of loaded beam specimens only in the restrained condition, where the two ends of the beam specimen (including slab ends for composite steel-concrete beam specimens) are placed tightly against the test frame that supports the beam specimen. Therefore, during fire exposure, the thermal expansion and rotation of the beam specimen ends are resisted by the test frame. Similar restrained condition is provided in the ASTM E119 tests on restrained loaded floor or roof assemblies, where the entire perimeter of the assembly is placed tightly against the test frame.

The practice of restrained specimens dates back to the early fire tests (over 100 years ago), and it is predominant today in the qualification of structural steel framed and reinforced concrete floors, roofs and beams in North America. While the current ASTM E119 standard does provide for an option to test loaded floor and roof assemblies in the unrestrained condition, this testing option is rarely used for structural steel and concrete. However, unrestrained loaded floor and roof specimens, with sufficient space around the perimeter to allow for free thermal expansion and rotation, are common in the tests of wood and cold-formed-steel framed assemblies.

Gewain and Troup (2001) provide a detailed review of the background research and practices in the qualification fire resistance testing and rating of structural steel (and composite steel/concrete) girders, beams, and steel framed floors and roofs. The restrained assembly fire resistance ratings (developed from tests on loaded restrained floor or roof specimens) and the restrained beam fire resistance

ratings (developed from tests on loaded restrained beam specimens) are commonly applicable to all types (with minor exceptions) of steel framed floors, roofs, girders and beams, as recommended in Table X3.1 of ASTM E119, especially where they incorporate or support cast-in-place or prefabricated concrete slabs. Ruddy et al. (2003) provides several detailed examples of steel framed floor and roof designs by qualification testing.

4.3.3. Unrestrained Construction

An unrestrained condition is one in which thermal expansion at the support of load-carrying elements is not resisted by forces external to the element and the supported ends are free to expand and rotate.

However, in the common practice for structural steel (and composite steel-concrete) beams and girders, the unrestrained beam ratings are developed from ASTM E119 tests on loaded restrained beam specimens or from ASTM E119 tests on loaded restrained floor or roof specimens, based only on temperature measurements on the surface of structural steel members. For steel framed floors and roofs, the unrestrained assembly ratings are developed from ASTM E119 tests on loaded restrained floor and roof specimens, based only on temperature measurements on the surface of the steel deck (if any) and on the surface of structural steel members. As such, the unrestrained fire resistance ratings are temperature-based ratings indicative of the time when the steel reaches specified temperature limits. These unrestrained ratings do not bear much direct relevance to the unrestrained condition or the load-bearing functions of the specimens in fire tests.

Nevertheless, unrestrained ratings provide useful supplementary information, and they are used as a conservative estimate of fire resistance (in lieu of the restrained ratings) in cases where the surrounding or supporting construction cannot be expected to accommodate the thermal expansion of steel beams or girders. For instance, as recommended in Table X3.1 of ASTM E119, a steel member bearing on a wall in a single span or at the end span of multiple spans should be considered unrestrained when the wall has not been designed and detailed to resist thermal thrust.

BIBLIOGRAPHY

The following references provide further information on key issues related to fire-resistant design of steel building systems and components, and are representative of the extensive literature on the topic. The references were selected because they are archival in nature or otherwise easily accessible by engineers seeking to design fire-resistance into building structures.

- AISI (1980), *Designing Fire Protection for Steel Columns*, American Iron and Steel Institute, Washington, DC.
- Bailey, C.G. (2000), “The Influence of the Thermal Expansion of Beams on the Structural Behavior of Columns in Steel-Framed Structures During a Fire,” *Engineering Structures*, Vol. 22, No. 7, pp. 755–768.
- Bennetts, I.D. and Thomas, I.R. (2002), “Design of Steel Structures under Fire Conditions,” *Progress in Structural Engineering and Materials*, Vol. 4, No. 1, pp. 6–17.
- Boring, D.F., Spence, J.C. and Wells, W.G. (1981), *Fire Protection Through Modern Building Codes*, 5th Ed., American Iron and Steel Institute, Washington, DC.
- Brozzetti, J., Law, M., Pettersson, O. and Witteveen, J. (1983), “Safety Concepts and Design for Fire Resistance of Steel Structures,” IABSE Surveys S-22/83, IABSE Periodica 1/1983, ETH-Honggerberg, Zurich, Switzerland.
- Chalk, P.L. and Corotis, R.B. (1980), “Probability Model for Design Live Loads,” *Journal of the Structures Division*, ASCE, Vol. 106, No. ST10, pp. 2,017–2,033.
- Chan, S.L. and Chan, B.H.M. (2001), “Refined Plastic Hinge Analysis of Steel Frames under Fire,” *Steel and Composite Structures*, Vol. 1, No. 1, pp. 111–130.
- CIB W14 (1983), “A Conceptual Approach Towards a Probability Based Design Guide on Structural Fire Safety,” *Fire Safety Journal*, Vol. 6, No. 1, pp. 1–79.
- CIB W14 (2001), “Rational Safety Engineering Approach to Fire Resistance of Buildings,” CIB Report No. 269, International Council for Research and Innovation in Building and Construction, Rotterdam, The Netherlands.
- Culver, C.G. (1978), “Characteristics of Fire Loads in Office Buildings,” *Fire Technology*, Vol. 1,491, pp. 51–60.
- Huang, Z., Burgess, I.W. and Plank, R.J. (2000), “Three-Dimensional Analysis of Composite Steel-Framed Buildings in Fire,” *Journal of Structural Engineering*, ASCE, Vol. 126, No. 3, pp. 389–397.
- Jeanes, D.C. (1985), “Application of the Computer in Modeling Fire Endurance of Structural Steel Floor Systems,” *Fire Safety Journal*, Vol. 9, pp. 119–135.
- Kruppa, J. (2000), “Recent Developments in Fire Design,” *Progress in Structures Engineering and Materials*, Vol. 2, No. 1, pp. 6–15.
- Lane, B. (2000), “Performance-Based Design for Fire Resistance,” *Modern Steel Construction*, AISC, December, pp. 54–61.
- Lawson, R.M. (2001), “Fire Engineering Design of Steel and Composite Buildings,”

- Journal of Constructional Steel Research*, Vol. 57, pp. 1,233–1,247.
- Lie, T.T. (1978), “Fire Resistance of Structural Steel,” *Engineering Journal*, AISC, Vol. 15, No. 4, pp. 116–125.
- Lie, T.T. and Almand, K.H. (1990), “A Method to Predict the Fire Resistance of Steel Building Columns,” *Engineering Journal*, AISC, Vol. 27, pp. 158–167.
- Magnusson, S.E. and Thelandersson, S. (1974), “A Discussion of Compartment Fires,” *Fire Technology*, Vol. 10, No. 4, pp. 228–246.
- Milke, J.A. (1985), “Overview of Existing Analytical Methods for the Determination of Fire Resistance,” *Fire Technology*, Vol. 21, No. 1, pp. 59–65.
- Milke, J.A. (1992), “Software Review: Temperature Analysis of Structures Exposed to Fire,” *Fire Technology*, Vol. 28, No. 2, pp. 184–189.
- Newman, G. (1999), “The Cardington Fire Tests,” *Proceedings of the North American Steel Construction Conference*, Toronto, Canada, AISC, Chicago, IL, pp. 28.1–28.22.
- Nwosu, D.I. and Kodur, V.K.R. (1999), “Behavior of Steel Frames Under Fire Conditions,” *Canadian Journal of Civil Engineering*, Vol. 26, pp. 156–167.
- Sakumoto, Y. (1992), “High-Temperature Properties of Fire-Resistant Steel for Buildings,” *Journal of Structural Engineering*, ASCE, Vol. 18, No. 2, pp. 392–407.
- Sakumoto, Y. (1999), “Research on New Fire-Protection Materials and Fire-Safe Design,” *Journal of Structural Engineering*, ASCE, Vol. 125, No. 12, pp. 1,415–1,422.
- Toh, W.S., Tan, K.H. and Fung, T.C. (2001), “Strength and Stability of Steel Frames in Fire: Rankine Approach,” *Journal of Structural Engineering*, ASCE, Vol. 127, No. 4, pp. 461–468.
- Usmani, A.S., Rotter, J.M., Lamont, S., Sanad, A.M. and Gillie, M. (2001), “Fundamental Principles of Structural Behaviour Under Thermal Effects,” *Fire Safety Journal*, Vol. 36, No. 8.
- Wang, Y.C. and Moore, D.B. (1995), “Steel Frames in Fire: Analysis,” *Engineering Structures*, Vol. 17, No. 6, pp. 462–472.
- Wang, Y.C. and Kodur, V.K.R. (2000), “Research Toward Use of Unprotected Steel Structures,” *Journal of Structural Engineering*, ASCE, Vol. 120, No. 12, pp. 1,442–1,450.
- Wang, Y.C. (2000), “An Analysis of the Global Structural Behavior of the Cardington Steel-Framed Building During the Two BRE Fire Tests,” *Engineering Structures*, Vol. 22, pp. 401–412.

APPENDIX 5

EVALUATION OF EXISTING STRUCTURES

5.1. GENERAL PROVISIONS

The load combinations referred to in this chapter pertain to gravity loading because it is the most prevalent condition encountered. If other loading conditions are a consideration, such as lateral loads, the appropriate load combination from ASCE/SEI 7 (ASCE, 2010) or from the applicable building code should be used.

For seismic evaluation of existing buildings, ASCE/SEI 31 (ASCE, 2003) provides a three-tiered process for determination of the design and construction adequacy of existing buildings to resist earthquakes. The standard defines evaluation requirements as well as detailed evaluation procedures. Buildings may be evaluated in accordance with this standard for life safety or immediate occupancy performance levels. Where seismic rehabilitation of existing structural steel buildings is required, engineering of seismic rehabilitation work may be performed in accordance with the ASCE/SEI 41 (ASCE, 2006) standard or other standards. Use of the above two standards for seismic evaluation and seismic rehabilitation of existing structural steel buildings is subject to the approval of the authority having jurisdiction.

5.2. MATERIAL PROPERTIES

1. Determination of Required Tests

The extent of tests required depends on the nature of the project, the criticality of the structural system or member evaluated, and the availability of records pertinent to the project. Thus, the engineer of record has the responsibility to determine the specific tests required and the locations from which specimens are to be obtained.

2. Tensile Properties

Samples required for tensile tests should be removed from regions of reduced stress, such as at flange tips at beam ends and external plate edges, to minimize the effects of the reduced area. The number of tests required will depend on whether they are conducted to merely confirm the strength of a known material or to establish the strength of some other steel.

It should be recognized that the yield stress determined by standard ASTM methods and reported by mills and testing laboratories is somewhat greater than the static yield stress because of dynamic effects of testing. Also, the test specimen location may have an effect. These effects have already been accounted for in the nominal strength equations in the Specification. However, when strength evaluation is done by load testing, this effect should be accounted for in test planning because yielding will tend to occur earlier than otherwise anticipated. The static yield stress, F_{ys} , can be estimated from that determined by routine application of ASTM methods, F_y , by the following equation (Galambos, 1978, 1998):

$$F_{ys} = R (F_y - 4) \quad (\text{C-A-5-1})$$

$$[\text{S.I.: } F_{ys} = R (F_y - 27)] \quad (\text{C-A-5-1M})$$

where

F_{ys} = static yield stress, ksi (MPa)

F_y = reported yield stress, ksi (MPa)

R = 0.95 for tests taken from web specimens

= 1.00 for tests taken from flange specimens

The R factor in Equation C-A-5-1 accounts for the effect of the coupon location on the reported yield stress. Prior to 1997, certified material test reports for structural shapes were based on specimens removed from the web, in accordance with ASTM A6/A6M (ASTM, 2009f). Subsequently the specified coupon location was changed to the flange.

4. Base Metal Notch Toughness

The engineer of record shall specify the location of samples. Samples shall be cored, flame cut or saw cut. The engineer of record will determine if remedial actions are required, such as the possible use of bolted splice plates.

5. Weld Metal

Because connections typically are more reliable than structural members, strength testing of weld metal is not usually necessary. However, field investigations have sometimes indicated that complete-joint-penetration groove welds, such as at beam-to-column connections, were not made in accordance with AWS D1.1/D1.1M (AWS, 2010). The specified provisions in AWS D1.1/D1.1M Section 5.24 provide a means for judging the quality of such a weld. Where feasible, any samples removed should be obtained from compression splices rather than tension splices, because the effects of repairs to restore the sampled area are less critical.

6. Bolts and Rivets

Because connections typically are more reliable than structural members, removal and strength testing of fasteners is not usually necessary. However, strength testing of bolts is required where they can not be properly identified otherwise. Because removal and testing of rivets is difficult, assuming the lowest rivet strength grade simplifies the investigation.

5.3. EVALUATION BY STRUCTURAL ANALYSIS

2. Strength Evaluation

Resistance and safety factors reflect variations in determining strength of members and connections, such as uncertainty in theory and variations in material properties and dimensions. If an investigation of an existing structure indicates that there are variations in material properties or dimensions significantly greater than those anticipated in new construction, the engineer of record should consider the use of more conservative values.

5.4. EVALUATION BY LOAD TESTS

1. Determination of Load Rating by Testing

Generally, structures that can be designed according to the provisions of this Specification need no confirmation of calculated results by testing. However, special situations may arise when it is desirable to confirm by tests the results of calculations. Minimal test procedures are provided to determine the live load rating of a structure. However, in no case is the live load rating determined by testing to exceed that which can be calculated using the provisions of this Specification. This is not intended to preclude testing to evaluate special conditions or configurations that are not adequately covered by this Specification.

It is essential that the engineer of record take all necessary precautions to ascertain that the structure does not fail catastrophically during testing. A careful assessment of structural conditions before testing is a fundamental requirement. This includes accurate measurement and characterization of the size and strength of members, connections and details. All safety regulations of OSHA and other pertinent bodies must be strictly followed. Shoring and scaffolding should be used as required in the proximity of the test area to mitigate against unexpected circumstances. Deformations must be carefully monitored and structural conditions must be continually evaluated. In some cases it may be desirable to monitor strains as well.

The engineer of record must use judgment to determine when deflections are becoming excessive and terminate the tests at a safe level even if the desired loading has not been achieved. Incremental loading is specified so that deformations can be accurately monitored and the performance of the structure carefully observed. Load increments should be small enough initially so that the onset of significant yielding can be determined. The increment can be reduced as the level of inelastic behavior increases, and the behavior at this level carefully evaluated to determine when to safely terminate the test. Periodic unloading after the onset of inelastic behavior will help the engineer of record determine when to terminate the test to avoid excessive permanent deformation or catastrophic failure.

It must be recognized that the margin of safety at the maximum load level used in the test may be very small, depending on such factors as the original design, the purpose of the tests, and the condition of the structure. Thus, it is imperative that all appropriate safety measures be adopted. It is recommended that the maximum live load used for load tests be selected conservatively. It should be noted that experience in testing more than one bay of a structure is limited.

The provision limiting increases in deformations for a period of one hour is given so as to have positive means to confirm that the structure is stable at the loads evaluated.

2. Serviceability Evaluation

In certain cases serviceability performance must be determined by load testing. It should be recognized that complete recovery (in other words, return to initial deflected shape) after removal of maximum load is unlikely because of phenomena

such as local yielding, slip at the slab interface in composite construction, creep in concrete slabs, localized crushing or deformation at shear connections in slabs, slip in bolted connections, and effects of continuity. Because most structures exhibit some slack when load is first applied, it is appropriate to project the load-deformation curve back to zero load to determine the slack and exclude it from the recorded deformations. Where desirable, the applied load sequence can be repeated to demonstrate that the structure is essentially elastic under service loads and that the permanent set is not detrimental.

5.5. EVALUATION REPORT

Extensive evaluation and load testing of existing structures is often performed when appropriate documentation no longer exists or when there is considerable disagreement about the condition of a structure. The resulting evaluation is only effective if well documented, particularly when load testing is involved. Furthermore, as time passes, various interpretations of the results can arise unless all parameters of the structural performance, including material properties, strength, and stiffness, are well documented.

APPENDIX 6

STABILITY BRACING FOR COLUMNS AND BEAMS

6.1. GENERAL PROVISIONS

Winter (1958, 1960) developed the concept of a dual requirement for bracing design, which involves criteria for both strength and stiffness. The design requirements of Appendix 6 are based upon this approach [for more discussion, see Ziemian (2010)] and consider two general types of bracing systems, relative and nodal, as shown in Figure C-A-6.1.

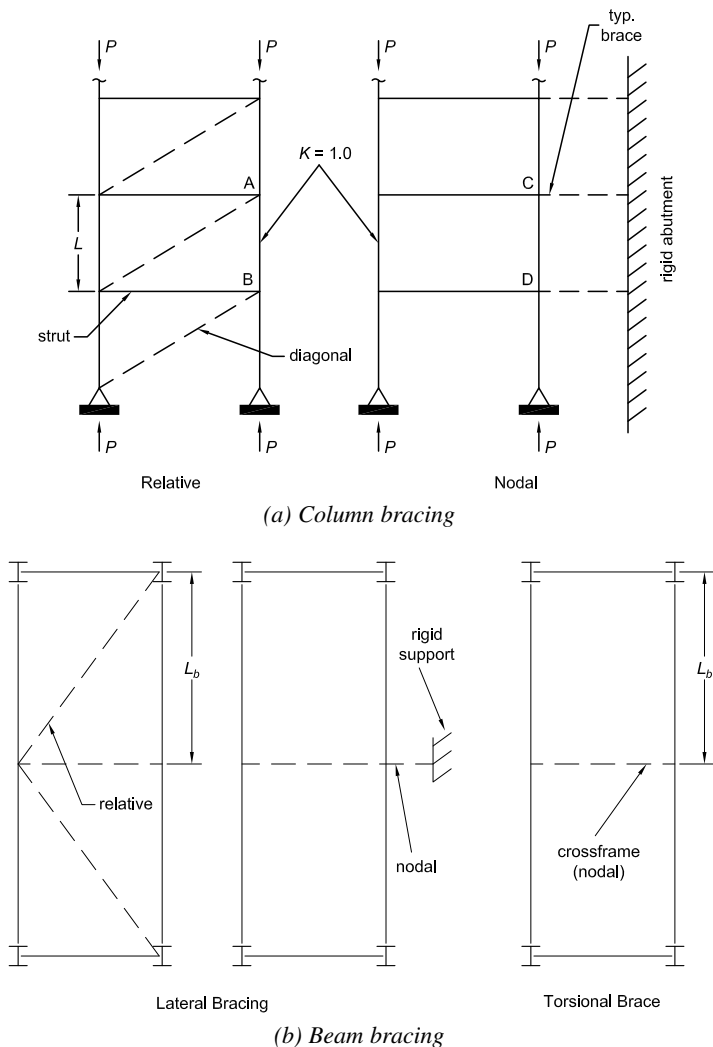

Fig. C-A-6.1. Types of bracing.

A relative brace for a column (such as diagonal bracing or shear walls) is attached to two locations along the length of the column. The distance between these locations is the unbraced length, L , of the column, for which $K = 1.0$ can be used. The relative bracing system shown in Figure C-A-6.1(a) consists of the diagonals and struts that control the movement at one end of the unbraced length, A , with respect to the other end of the unbraced length, B . The forces in these bracing elements are resolved by the forces in the beams and columns in the frame that is braced. The diagonal and strut both contribute to the strength and stiffness of the relative bracing system. However, when the strut is a floor beam and the diagonal a brace, the floor beam stiffness is usually large compared to the stiffness of the brace. In such a case, the brace strength and stiffness often controls the strength and stiffness of the relative bracing system.

A nodal brace for a column controls movement only at the point it braces, and without direct interaction with adjacent braced points. The distance between adjacent braced points is the unbraced length, L , of the column, for which $K = 1.0$ can be used. The nodal bracing system shown in Figure C-A-6.1(a) consists of a series of independent braces, which connect to a rigid abutment, from braced points, including C and D . The forces in these bracing elements are resolved by other structural elements not part of the frame that is braced.

As illustrated in Figure C-A-6.1(b), a relative bracing system for a beam commonly consists of a system with diagonals; a nodal bracing system commonly exists when there is a link to an external support or a cross-frame between two adjacent beams. The cross-frame prevents twist (not lateral displacement) of the beams only at the particular cross frame location. With the required lateral and rotational restraint provided at the beam ends, the unbraced length, L_b , in all of these cases is the distance from the support to the braced point.

The bracing requirements stipulated for columns in this Section enable the column to sustain its maximum load based on the unbraced length, L , between the brace points and the use of $K = 1.0$. This is not the same as the no-*sidesway* case. As illustrated in Figure C-A-6.2 for a cantilevered column with a brace of variable stiffness

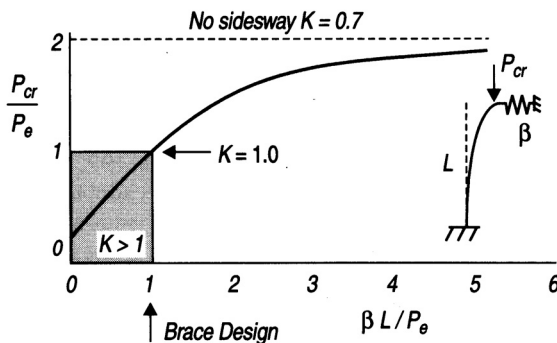

Fig. C-A-6.2. Cantilevered column with brace at top.

at the top, the critical stiffness with $K = 1.0$ is P_e/L . However, a brace with five times this stiffness only reaches 95% of the value required for the use of $K = 0.7$, and an infinitely stiff brace would be required to reach the no-sway limit, in theory. Similarly, the determination of bracing required to reach specified rotation capacities or ductility limits is beyond the scope of these recommendations.

The provisions for required brace stiffness, β_{br} , in Sections 6.2 and 6.3 for columns and beams, respectively, have been selected equal to twice the critical stiffness, and all bracing stiffness provisions have $\phi = 0.75$ and $\Omega = 2.00$. The required brace strength, P_{rb} , is a function of the initial out-of-straightness, Δ_o , and the brace stiffness, β . ϕ and Ω are not involved in the calculation of required brace strength; they are applied when the provisions in other chapters of this Specification are applied to design the members and connections provided to resist these forces.

For a relative bracing system, the relationship between column load, brace stiffness and sway displacement is shown in Figure C-A-6.3. If the bracing stiffness, β , is equal to the critical brace stiffness for a perfectly plumb member, β_i , P approaches P_e as the sway deflection increases. However, such large displacements would produce large bracing forces, and Δ must be kept small for practical design.

For the relative bracing system shown in Figure C-A-6.3, the use of $\beta_{br} = 2\beta_i$ and an initial displacement of $\Delta_o = L/500$ results in P_{rb} equal to 0.4% of P_e . In the foregoing, L is the distance between adjacent braced points as shown in Figure C-A-6.4, and Δ_o is the displacement from the straight position at the braced points caused by lateral loads, erection tolerances, column shortening, and other sources, but not including brace elongations from gravity loads.

As stated in the Chapter C, the use of $\Delta_o = L/500$ is based upon the maximum frame out-of-plumbness specified in the AISC *Code of Standard Practice for Steel Buildings and Bridges* (AISC, 2010a). Similarly, for torsional bracing of beams an initial rotation, $\theta_o = L/(500h_o)$, is assumed, where h_o is the distance between flange centroids. For other values of Δ_o and θ_o , it is permissible to modify the bracing required strengths, P_{rb} and M_{rb} , by direct proportion. For cases where it is unlikely that all columns in a story will be out-of-plumb in the same direction, Chen and Tong (1994) recommend an average initial displacement of $\Delta_o = L / (500\sqrt{n_o})$, where n_o

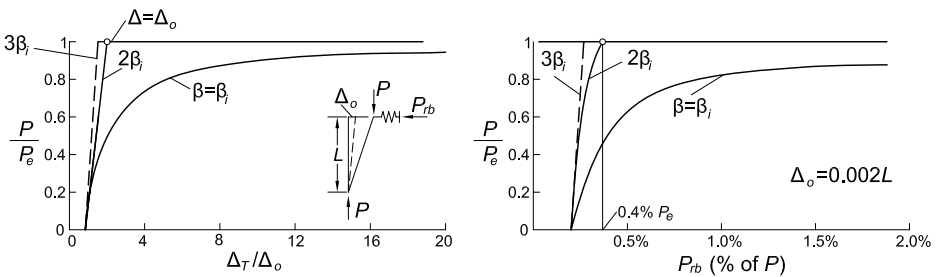

Fig. C-A-6.3. Effect of initial out-of-plumbness.

is the number of columns, each with a random Δ_0 , stabilized by the bracing system. This reduced Δ_0 would be appropriate when combining the stability brace forces with wind and seismic forces.

If the actual bracing stiffness provided, β_{act} , is larger than β_{br} , the required brace strength, P_{rb} (or M_{rb} in the case of a torsional brace), can be multiplied by the following factor:

$$\frac{1}{2 - \frac{\beta_{br}}{\beta_{act}}} \quad (\text{C-A-6-1})$$

Connections in the bracing system, if they are flexible or can slip, should be considered in the evaluation of the bracing stiffness as follows:

$$\frac{1}{\beta_{act}} = \frac{1}{\beta_{conn}} + \frac{1}{\beta_{brace}} \quad (\text{C-A-6-2})$$

The resulting bracing system stiffness, β_{act} , is less than the smaller of the connection stiffness, β_{conn} , and the brace stiffness, β_{brace} . Slip in connections with standard holes need not be considered, except when only a few bolts are used.

When evaluating the bracing of rows of columns or beams, consideration must be given to the accumulation of the bracing forces, which may result in a different displacement at each column or beam location. In general, bracing forces can be minimized by increasing the number of braced bays and using stiff braces.

Member inelasticity has no significant effect on stability bracing requirements (Yura, 1995).

6.2. COLUMN BRACING

For nodal column bracing, the critical stiffness is a function of the number of intermediate braces (Winter, 1958, 1960). For one intermediate brace, $\beta_i = 2P_r/L_b$, and for many braces, $\beta_i = 4P_r/L_b$. The relationship between the critical stiffness and the number of braces, n , can be approximated (Yura, 1995) as:

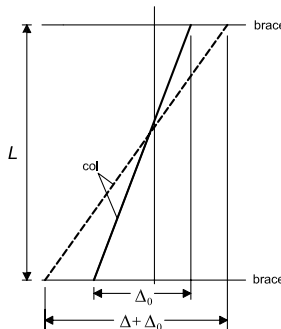

Fig. C-A-6.4. Definitions of initial displacements for relative and nodal braces.

$$\beta_i = \left(4 - \frac{2}{n}\right) \frac{P_r}{L_b} \quad (\text{C-A-6-3})$$

The most severe case (many braces) was adopted for the brace stiffness requirement, $\beta_{br} = 2 \times 4P/L_b$. The brace stiffness in Equation A-6-4 can be multiplied by the following ratio to account for the actual number of braces:

$$\left(\frac{2n-1}{2n}\right) \quad (\text{C-A-6-4})$$

The unbraced length, L_b , in Equation A-6-4 is assumed equal to the length, KL , that enables the column to reach P_r . When the actual brace spacing is less than the value of KL so determined, the calculated required stiffness may become quite conservative since the stiffness equations are inversely proportional to L_b . In such cases, L_b can be taken equal to KL . This substitution is also permitted for the beam nodal bracing formulations given in Equations A-6-8 and A-6-9.

For example, a W12×53 (W310×79) with $P_u = 400$ kips (1 780 kN) for LRFD or $P_a = 267$ kips (1 190 kN) for ASD can have a maximum unbraced length of 18 ft (5.5 m) for ASTM A992 steel. If the actual brace spacing is 8 ft (2.4 m), 18 ft (5.5 m) may be used in Equation A-6-4 to determine the required stiffness. The use of L_b equal to the value of KL in Equation A-6-4 provides reasonable estimates of the brace stiffness requirements; however, the solution can still result in conservative estimates of the stiffness requirements. Improved accuracy can be obtained by treating the system as a continuous bracing system (Lutz and Fisher, 1985; Ziemian, 2010).

With regard to the brace strength requirements, Winter's rigid model only accounts for force effects from lateral displacements and would derive a brace force equal to 0.8% of P_r , which accounts only for lateral displacement force effects. To account for the additional force due to member curvature, this theoretical force has been increased to 1% of P_r .

6.3. BEAM BRACING

Beam bracing must control twist of the section, but need not prevent lateral displacement. Both lateral bracing, such as a steel joists attached to the compression flange of a simply supported beam, and torsional bracing, such as a cross-frame or diaphragm between adjacent girders, can be used to control twist. Note, however, that lateral bracing systems that are attached only near the beam centroid are generally ineffective in controlling twist.

For beams subject to reverse-curvature bending, an unbraced inflection point cannot be considered a braced point because twist can occur at that point (Ziemian, 2010). If bracing is needed, lateral bracing provided near an inflection point must be attached to both flanges to prevent twist; alternatively, torsional bracing can be provided. A lateral brace on one flange near the inflection point is ineffective.

The beam bracing requirements in this Section are based on the recommendations of Yura (2001).

1. Lateral Bracing

For lateral bracing, the following stiffness requirement is derived following Winter's approach:

$$\beta_{br} = 2N_i C_t (C_b P_f) C_d / \phi L_b \quad (\text{C-A-6-5})$$

where

$N_i = 1.0$ for relative bracing

$= (4-2/n)$ for nodal bracing

$C_t = 1.0$ for centroidal loading

$= 1 + (1.2/n)$ for top-flange loading

$n =$ number of intermediate braces

$P_f =$ beam compressive flange force, kips (N)

$= \pi^2 E I_{yc} / L_b^2$

$I_{yc} =$ out-of-plane moment of inertia of the compression flange, in.⁴ (mm⁴)

$C_b =$ lateral-torsional buckling modification factor from Chapter F

$C_d =$ double curvature factor (compression in both flanges)

$= 1 + (M_S / M_L)^2$

$M_S =$ smallest moment causing compression in either flange, kip-ft (N-mm)

$M_L =$ largest moment causing compression in each flange, kip-ft (N-mm)

The C_d factor varies between 1 and 2, and is applied only to the brace closest to the inflection point. The term $(2N_i C_t)$ can be conservatively approximated as 10 for any number of nodal braces and 4 for relative bracing, and $(C_b P_f)$ can be approximated by M_r / h_o , which simplifies Equation C-A-6-5 to the stiffness requirements given by Equations A-6-6 and A-6-8. Equation C-A-6-5 can be used in lieu of Equations A-6-6 and A-6-8.

The brace strength requirement for relative bracing is

$$P_{rb} = 0.004 M_r C_t C_d / h_o \quad (\text{C-A-6-6a})$$

and for nodal bracing

$$P_{rb} = 0.01 M_r C_t C_d / h_o \quad (\text{C-A-6-6b})$$

They are based on an assumed initial lateral displacement of the compression flange of $0.002L_b$. The brace strength requirements of Equations A-6-5 and A-6-7 are derived from Equations C-A-6-6a and C-A-6-6b assuming top flange loading ($C_t = 2$). Equations C-A-6-6a and C-A-6-6b can be used in lieu of Equations A-6-5 and A-6-7, respectively.

2. Torsional Bracing

Torsional bracing can either be attached continuously along the length of the beam (for example, metal deck or slabs) or be located at discrete points along the length of the member (for example, cross frames). With respect to the girder response, torsional bracing attached to the tension flange is just as effective as a brace attached at mid-depth or to the compression flange. Although the girder response is generally not sensitive to the brace location, the position of the brace on the cross section does have an effect on the stiffness of the brace itself. For example, a torsional brace

attached on the bottom flange will often bend in single curvature (for example, with a flexural stiffness of $2EI/L$ based on the brace properties), while a brace attached on the top flange will often bend in reverse curvature (for example, with a flexural stiffness of $6EI/L$ based on the brace properties). Partially restrained connections can be used if their stiffness is considered in evaluating the torsional brace stiffness.

The torsional brace requirements are based on the buckling strength of a beam with a continuous torsional brace along its length presented in Taylor and Ojalvo (1966) and modified for cross section distortion in Yura (2001), as follows.

$$M_r \leq M_{cr} = \sqrt{(C_{bu}M_o)^2 + \frac{C_b^2 EI_y \bar{\beta}_T}{2C_{it}}} \quad (\text{C-A-6-7})$$

The term $C_{bu}M_o$ is the buckling strength of the beam without torsional bracing. $C_{it} = 1.2$ when there is top flange loading and $C_{it} = 1.0$ for centroidal loading. $\bar{\beta}_T = n\beta_T/L$ is the continuous torsional brace stiffness per unit length or its equivalent when n nodal braces, each with a stiffness β_T , are used along the span, L , and the 2 accounts for initial out-of-straightness. Neglecting the unbraced beam buckling term gives a conservative estimate of the torsional brace stiffness requirement (Equation A-6-11).

The strength requirements for beam torsional bracing were developed based upon an assumed initial twist imperfection of $\theta_o = 0.002L_b/h_o$, where h_o is equal to the depth of the beam. Providing at least twice the ideal stiffness results in a brace force, $M_{rb} = \beta_T\theta_o$. Using the formulation of Equation A-6-11 (without ϕ or Ω), the strength requirement for the torsional bracing is

$$\begin{aligned} M_{rb} &= \beta_T\theta_o \\ &= \left(\frac{2.4LM_r^2}{nEI_y C_b^2} \right) \left(\frac{L_b}{500h_o} \right) \end{aligned} \quad (\text{C-A-6-8})$$

To obtain Equation A-6-9, the equation was simplified as follows:

$$\begin{aligned} M_{rb} &= \left(\frac{2.4LM_r^2}{nEI_y C_b^2} \right) \left(\frac{L_b}{500h_o} \right) \left(\frac{\pi^2 L_b^2}{\pi^2 L_b^2} \right) \\ &= \left(\frac{2.4\pi^2 M_r L}{500n C_b L_b} \right) \left(\frac{M_r}{h_o} \right) \left(\frac{L_b^2}{C_b \pi^2 EI_y} \right) \end{aligned} \quad (\text{C-A-6-9})$$

The term M_r/h_o can be approximated as the flange force, P_f , and the term $L_b^2/C_b \pi^2 EI_y$ can be represented as the reciprocal of twice the buckling strength of the flange [$1/(2P_f)$]. Substituting for these terms and evaluating the constants results in

$$M_{rb} = \frac{0.024 M_r L}{n C_b L_b} \quad (\text{C-A-6-10})$$

which is the expression given in Equation A-6-9.

Equations A-6-9 and A-6-12 give the strength and stiffness requirements for doubly symmetric beams. For singly symmetric sections these equations will generally be

conservative. Better estimates of the strength requirements for torsional bracing of singly symmetric sections can be obtained with Equation C-A-6-8 by replacing I_y with I_{eff} as given in the following expression:

$$I_{eff} = I_{yc} + \left(\frac{t}{c}\right)I_{yt} \quad (\text{C-A-6-11})$$

where

- t = distance from the neutral axis to the extreme tensile fibers, in. (mm)
- c = distance from the neutral axis to the extreme compressive fibers, in. (mm)
- I_{yc} and I_{yt} = respective moments of inertia of compression and tension flanges about an axis through the web, in.⁴ (mm⁴)

Good estimates of the stiffness requirements of torsional braces for singly symmetric I-shaped beams may be obtained using Equation A-6-11 and replacing I_y with I_{eff} given in Equation C-A-6-11.

The β_{sec} term in Equations A-6-10, A-6-12 and A-6-13 accounts for cross section distortion. A web stiffener at the brace point reduces cross-sectional distortion and improves the effectiveness of a torsional brace. When a cross frame is attached near both flanges or a diaphragm is approximately the same depth as the girder, then web distortion will be insignificant so β_{sec} equals infinity. The required bracing stiffness, β_{Tb} , given by Equation A-6-10 was obtained by solving the following expression that represents the brace system stiffness including distortion effects:

$$\frac{1}{\beta_T} = \frac{1}{\beta_{Tb}} + \frac{1}{\beta_{sec}} \quad (\text{C-A-6-12})$$

Parallel chord trusses with both chords extended to the end of the span and attached to supports can be treated like beams. In Equations A-6-5 through A-6-9, M_u may be taken as the maximum compressive chord force times the depth of the truss to determine the brace strength and stiffness requirements. Cross-section distortion effects, β_{sec} , need not be considered when full-depth cross frames are used for bracing. When either chord does not extend to the end of the span, consideration should be given to control twist near the ends of the span by the use of cross frames or ties.

6.4. BEAM-COLUMN BRACING

The section on bracing for beam-columns was introduced in the 2010 edition. The bracing requirements for compression and those for flexure are, in effect, superimposed to arrive at the requirements for beam-columns. This approach will tend to be conservative and a more refined solution obtained by rational analysis may be desirable.

APPENDIX 7

ALTERNATIVE METHODS OF DESIGN FOR STABILITY

The effective length method and first-order analysis method are addressed in this Appendix as alternatives to the direct analysis method, which is presented in Chapter C. These alternative methods of design for stability can be used when the limits on their use as defined in Appendix Sections 7.2.1 and 7.3.1, respectively, are satisfied.

Both methods in this Appendix utilize the nominal geometry and the nominal elastic stiffnesses (EI , EA) in the analysis. Accordingly, it is important to note that the *sidesway* amplification ($\Delta_{2nd-order}/\Delta_{1st-order}$ or B_2) limits specified in Chapter C and Appendix 7 are different. For the direct analysis method in Chapter C, the limit of 1.7 for certain requirements is based upon the use of reduced stiffnesses (EI^* and EA^*). For the effective length method and first-order analysis method, the equivalent limit of 1.5 is based upon the use of unreduced stiffnesses (EI and EA).

7.2. EFFECTIVE LENGTH METHOD

The effective length method (though it was not formally identified by this name) has been used in various forms in the AISC Specification since 1961. The current provisions are essentially the same as those in Chapter C of the 2005 *Specification for Structural Steel Buildings* (AISC, 2005a), with the following exceptions:

These provisions, together with the use of a column effective length greater than the actual length for calculating available strength in some cases, account for the effects of initial out-of-plumbness and member stiffness reductions due to the spread of plasticity. No stiffness reduction is required in the analysis.

The effective length, KL , for column buckling based upon elastic (or inelastic) stability theory, or alternatively the equivalent elastic column buckling load, $F_e = \pi^2 EI / (KL)^2$, is used to calculate an axial compressive strength, P_c , through an empirical *column curve* that accounts for geometric imperfections and distributed yielding (including the effects of *residual stresses*). This column strength is then combined with the flexural strength, M_c , and second-order member forces, P_r and M_r , in the beam-column interaction equations.

Braced Frames

Braced frames are commonly idealized as vertically cantilevered pin-connected truss systems, ignoring any secondary moments within the system. The effective length factor, K , of components of the braced frame is normally taken as 1.0, unless a smaller value is justified by structural analysis and the member and connection design is consistent with this assumption. If connection fixity is modeled in the analysis, the resulting member and connection moments must be accommodated in the design.

If $K < 1$ is used for the calculation of P_n in braced frames, the additional demands on the stability bracing systems and the influence on the second-order moments in beams providing restraint to the columns must be considered. The provisions in Appendix 6 do not address the additional demands on bracing members from the use of $K < 1$. Generally, a rigorous second-order elastic analysis is necessary for calculation of the second-order moments in beams providing restraint to column members designed based on $K < 1$. Therefore, design using $K = 1$ is recommended, except in those special situations where the additional calculations are deemed justified.

Moment Frames

Moment frames rely primarily upon the flexural stiffness of the connected beams and columns. Stiffness reductions due to shear deformations may require consideration when bay sizes are small and/or members are deep.









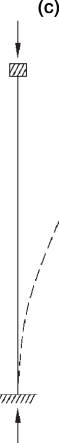
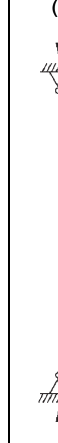

When the *effective length method* is used, the design of all beam-columns in moment frames must be based on an effective length, KL , greater than the actual length, L , except when specific exceptions based upon high structural stiffness are met. When the sidesway amplification ($\Delta_{2nd-order}/\Delta_{1st-order}$ or B_2) is equal to or less than 1.1, the frame design may be based on the use of $K = 1.0$ for the columns. This simplification for stiffer structures results in a 6% maximum error in the in-plane beam-column strength checks of Chapter H (White and Hajjar, 1997a). When the sidesway amplification is larger, K must be calculated.

A wide range of methods has been suggested in the literature for the calculation of K -factors (Kavanagh, 1962; Johnston, 1976; LeMessurier, 1977; ASCE Task Committee on Effective Length, 1997; White and Hajjar, 1997b). These range from simple idealizations of single columns as shown in Table C-A-7.1 to complex buckling solutions for specific frames and loading conditions. In some types of frames, K -factors are easily estimated or calculated, and are a convenient tool for stability design. In other types of structures, the determination of accurate K -factors is determined by tedious hand procedures, and system stability may be assessed more effectively with the direct analysis method.

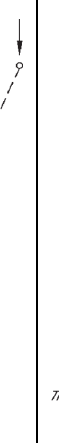
The most common method for determining K is through use of the *alignment charts*, which are shown in Figure C-A-7.1 for frames with sidesway inhibited and Figure C-A-7.2 for frames with sidesway uninhibited (Kavanagh, 1962). These charts are based on assumptions of idealized conditions, which seldom exist in real structures, as follows:

- (1) Behavior is purely elastic.
- (2) All members have constant cross section.
- (3) All joints are rigid.
- (4) For columns in frames with sidesway inhibited, rotations at opposite ends of the restraining beams are equal in magnitude and opposite in direction, producing single curvature bending.
- (5) For columns in frames with sidesway uninhibited, rotations at opposite ends of the restraining beams are equal in magnitude and direction, producing reverse curvature bending.
- (6) The stiffness parameter $L\sqrt{P/EI}$ of all columns is equal.

TABLE C-A-7.1
Approximate Values of Effective Length Factor, *K*

Buckled shape of column is shown by dashed line	(a)	(b)	(c)	(d)	(e)	(f)
						
Theoretical <i>K</i> value	0.5	0.7	1.0	1.0	2.0	2.0
Recommended design value when ideal conditions are approximated	0.65	0.80	1.2	1.0	2.1	2.0
End condition code	 <ul style="list-style-type: none">  Rotation fixed and translation fixed  Rotation free and translation fixed  Rotation fixed and translation free  Rotation free and translation free 					

- (7) Joint restraint is distributed to the column above and below the joint in proportion to EI/L for the two columns.
- (8) All columns buckle simultaneously.
- (9) No significant axial compression force exists in the girders.

The alignment chart for sidesway inhibited frames shown in Figure C-A-7.1 is based on the following equation:

$$\frac{G_A G_B}{4} (\pi / K)^2 + \left(\frac{G_A + G_B}{2} \right) \left(1 - \frac{\pi / K}{\tan(\pi / K)} \right) + \frac{2 \tan(\pi / 2K)}{(\pi / K)} - 1 = 0 \quad \text{(C-A-7-1)}$$

The alignment chart for sidesway uninhibited frames shown in Figure C-A-7.2 is based on the following equation:

$$\frac{G_A G_B (\pi / K)^2 - 36}{6(G_A + G_B)} - \frac{(\pi / K)}{\tan(\pi / K)} = 0 \quad \text{(C-A-7-2)}$$

where

$$G = \frac{\Sigma(E_c I_c / L_c)}{\Sigma(E_g I_g / L_g)} = \frac{\Sigma(EI / L)_c}{\Sigma(EI / L)_g} \tag{C-A-7-3}$$

The subscripts *A* and *B* refer to the joints at the ends of the column being considered. The symbol Σ indicates a summation of all members rigidly connected to that joint and located in the plane in which buckling of the column is being considered. E_c is the elastic modulus of the column, I_c is the moment of inertia of the column, and L_c is the unsupported length of the column. E_g is the elastic modulus of the girder, I_g is the moment of inertia of the girder, and L_g is the unsupported length of the girder or other restraining member. I_c and I_g are taken about axes perpendicular to the plane of buckling being considered. The alignment charts are valid for different materials if an appropriate effective rigidity, EI , is used in the calculation of G .

It is important to remember that the alignment charts are based on the assumptions of idealized conditions previously discussed and that these conditions seldom exist in real structures. Therefore, adjustments are often required, such as:

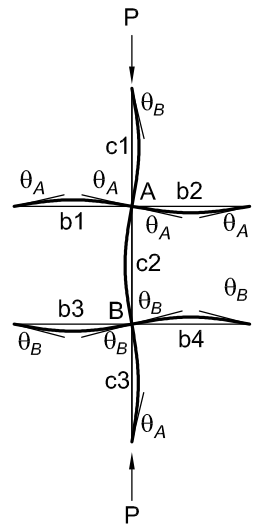
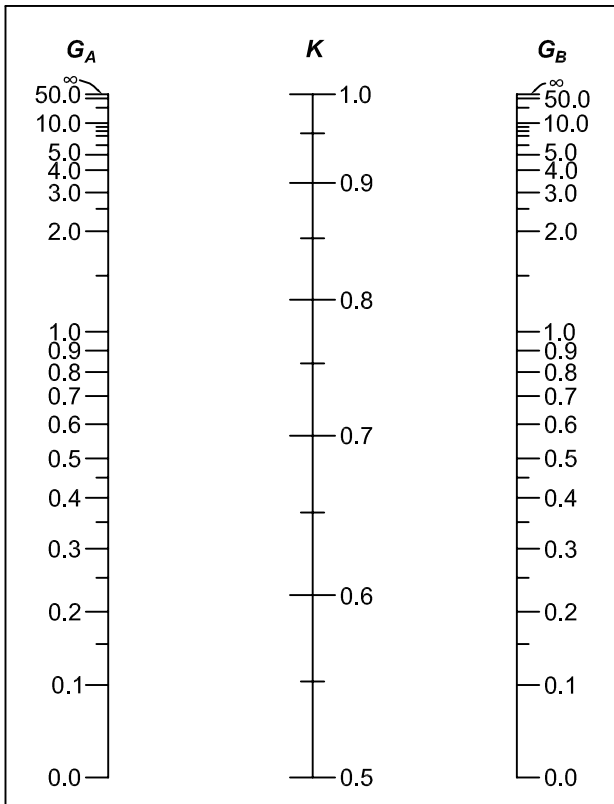

Fig. C-A-7.1. Alignment chart—sidesway inhibited (braced frame).

Adjustments for Columns With Differing End Conditions. For column ends supported by, but not rigidly connected to, a footing or foundation, G is theoretically infinity but unless designed as a true friction-free pin, may be taken as 10 for practical designs. If the column end is rigidly attached to a properly designed footing, G may be taken as 1.0. Smaller values may be used if justified by analysis.

Adjustments for Girders With Differing End Conditions. For sidesway inhibited frames, these adjustments for different girder end conditions may be made:

- (a) If the far end of a girder is fixed, multiply the $(EI/L)_g$ of the member by 2.
- (b) If the far end of the girder is pinned, multiply the $(EI/L)_g$ of the member by $1^{1/2}$.

For sidesway uninhibited frames and girders with different boundary conditions, the modified girder length, L'_g , should be used in place of the actual girder length, where

$$L'_g = L_g (2 - M_F/M_N) \tag{C-A-7-4}$$

M_F is the far end girder moment and M_N is the near end girder moment from a first-order lateral analysis of the frame. The ratio of the two moments is positive if the girder is in reverse curvature. If M_F/M_N is more than 2.0, then L'_g becomes negative,

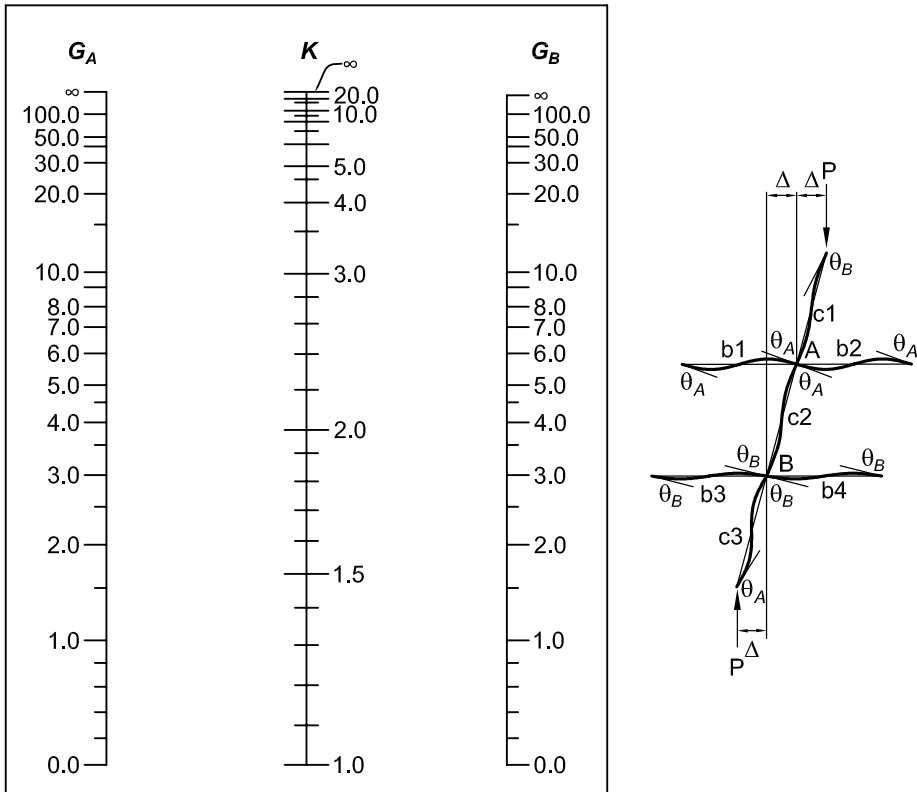

Fig. C-A-7.2. Alignment chart sidesway—uninhibited (moment frame).

in which case G is negative and the alignment chart equation must be used. For side-sway uninhibited frames, the following adjustments for different girder end conditions may be made:

- (a) If the far end of a girder is fixed, multiply the $(EI/L)_g$ of the member by $2/3$.
- (b) If the far end of the girder is pinned, multiply the $(EI/L)_g$ of the member by $1/2$.

Adjustments for Girders with Significant Axial Load. For both sidesway conditions, multiply the $(EI/L)_g$ by the factor $(1-Q/Q_{cr})$, where Q is the axial load in the girder and Q_{cr} is the in-plane buckling load of the girder based on $K = 1.0$.

Adjustments for Column Inelasticity. For both sidesway conditions, replace $(E_c I_c)$ with $\tau_b(E_c I_c)$ for all columns in the expression for G_A and G_B .

Adjustments for Connection Flexibility. One important assumption in the development of the alignment charts is that all beam-column connections are fully restrained (FR connections). As seen above, when the far end of a beam does not have an FR connection that behaves as assumed, an adjustment must be made. When a beam connection at the column under consideration is a shear-only connection, that is, there is no moment, then that beam cannot participate in the restraint of the column and it cannot be considered in the $\Sigma(EI/L)_g$ term of the equation for G . Only FR connections can be used directly in the determination of G . PR connections with a documented moment-rotation response can be utilized, but the $(EI/L)_g$ of each beam must be adjusted to account for the connection flexibility. The ASCE Task Committee on Effective Length (1997) provides a detailed discussion of frame stability with PR connections.

Combined Systems

When combined systems are used, all the systems must be included in the structural analysis. Consideration must be given to the variation in stiffness inherent in concrete or masonry shear walls due to various degrees to which these elements may experience cracking. This applies to load combinations for serviceability as well as strength. It is prudent for the designer to consider a range of possible stiffnesses, as well as the effects of shrinkage, creep and load history, in order to envelope the likely behavior and provide sufficient strength in all interconnecting elements between systems. Following the analysis, the available strength of compression members in moment frames must be assessed with effective lengths calculated as required for moment frame systems; other compression members may be assessed using $K = 1.0$.

Leaning Columns and Distribution of Sidesway Instability Effects

Columns in gravity framing systems can be designed as pin-ended columns with $K = 1.0$. However, the destabilizing effects ($P-\Delta$ effects) of the gravity loads on all such columns, and the load transfer from these columns to the lateral-load-resisting system, must be accounted for in the design of the lateral-load-resisting system.

It is important to recognize that sidesway instability of a building is a story phenomenon involving the sum of the sway resistances of all the lateral load-resisting elements in the story and the sum of the factored gravity loads in the columns in that

story. No individual column in a story can buckle in a sidesway mode without the entire story buckling.

If every column in a story is part of a moment frame and each column is designed to support its own axial load, P and P - Δ moment such that the contribution of each column to the lateral stiffness or to the story buckling load is proportional to the axial load supported by the column, all the columns will buckle simultaneously. Under this idealized condition, there is no interaction among the columns in the story; column sway instability and frame instability occur at the same time. Typical framing, however, does not meet this idealized condition, and real systems redistribute the story P - Δ effects to the lateral load-resisting elements in that story in proportion to their stiffnesses. This redistribution can be accomplished using such elements as floor diaphragms or horizontal trusses.

In a building that contains columns that contribute little or nothing to the sway stiffness of the story, such columns are referred to as leaning columns. These columns can be designed using $K = 1.0$, but the lateral load-resisting elements in the story must be designed to support the destabilizing P - Δ effects developed from the loads on these leaning columns. The redistribution of P - Δ effects among columns must be considered in the determination of K and F_e for all the columns in the story for the design of moment frames. The proper K -factor for calculation of P_c in moment frames, accounting for these effects, is denoted in the following by the symbol K_2 .

Effective Length for Story Stability

Two approaches for evaluating story stability are recognized: the story stiffness approach (LeMessurier, 1976, 1977) and the story buckling approach (Yura, 1971). Additionally, a simplified approach proposed by LeMessurier is also discussed.

The column effective length factor associated with lateral story buckling is expressed as K_2 in the following discussions. The value of K_2 determined from Equation C-A-7-5 or Equation C-A-7-8 may be used directly in the equations of Chapter E. However, it is important to note that this equation is not appropriate for use when calculating the story buckling mode as the summation of $\pi^2 EI / (K_2 L)^2$. Also, note that the value of P_c calculated using K_2 by either method cannot be taken greater than the value of P_c determined based on sidesway-inhibited buckling.

Story Stiffness Approach. For the story stiffness approach, K_2 is defined as

$$K_2 = \sqrt{\frac{\Sigma P_r}{(0.85 + 0.15 R_L) P_r} \left(\frac{\pi^2 EI}{L^2} \right) \left(\frac{\Delta_H}{\Sigma HL} \right)} \geq \sqrt{\frac{\pi^2 EI}{L^2} \left(\frac{\Delta_H}{1.7 HL} \right)} \quad (\text{C-A-7-5})$$

It is possible that certain columns, having only a small contribution to the lateral load resistance in the overall frame, will have a K_2 value less than 1.0 based on the term to the left of the inequality. The limit on the right-hand side is a minimum value for K_2 that accounts for the interaction between sidesway and non-sidesway buckling (ASCE Task Committee on Effective Length, 1997; White and Hajjar, 1997b). The term H is the shear in the column under consideration, produced by the lateral forces used to compute Δ_H .

Equation C-A-7-5 can be reformulated to obtain the column buckling load, P_{e2} , as

$$P_{e2} = \left(\frac{\Sigma HL}{\Delta_H} \right) \frac{P_r}{\Sigma P_r} (0.85 + 0.15R_L) \leq 1.7HL / \Delta_H \quad (\text{C-A-7-6})$$

R_L is the ratio of the vertical column load for all leaning columns in the story to the vertical load of all the columns in the story:

$$R_L = \frac{\Sigma P_r \text{ leaning columns}}{\Sigma P_r \text{ all columns}} \quad (\text{C-A-7-7})$$

The purpose of R_L is to account for the influence of P - δ effects on the sidesway stiffness of the columns in a story. ΣP_r in Equations C-A-7-5 and C-A-7-6 includes all columns in the story, including any leaning columns, and P_r is for the column under consideration. The column buckling load, P_{e2} , calculated from Equation C-A-7-6 may be larger than $\pi^2 EI/L^2$ but may not be larger than the limit on the righthand side of this equation.

The story stiffness approach is the basis for the B_2 calculation (for P - Δ effects) in Appendix 8. In Equation A-8-7 in Appendix 8, the buckling load for the story is expressed in terms of the story drift ratio, Δ_H/L , from a first-order lateral load analysis at a given applied lateral load level. In preliminary design, Δ_H/L may be taken in terms of a target maximum value for this drift ratio. This approach focuses the engineer's attention on the most fundamental stability requirement in building frames: providing adequate overall story stiffness in relation to the total vertical load, $\alpha \Sigma P_r$, supported by the story. The elastic story stiffness expressed in terms of the drift ratio and the total horizontal load acting on the story is $H/(\Delta_H/L)$.

Story Buckling Approach. For the story buckling approach, K_2 is defined as

$$K_2 = \sqrt{\frac{\pi^2 EI}{L^2} \left(\frac{\Sigma P_r}{\Sigma \frac{\pi^2 EI}{(K_{n2}L)^2}} \right)} \geq \sqrt{\frac{5}{8}} K_{n2} \quad (\text{C-A-7-8})$$

where K_{n2} is defined as the value of K determined directly from the alignment chart in Figure C-A-7.2.

The value of K_2 calculated from the above equation may be less than 1.0. The limit on the righthand side is a minimum value for K_2 that accounts for the interaction between sidesway and non-sidesway buckling (ASCE Task Committee on Effective Length, 1997; White and Hajjar, 1997b; Geschwindner, 2002; AISC-SSRC, 2003a). Other approaches to calculating K_2 are given in previous editions of this Commentary and the foregoing references.

Equation C-A-7-8 can be reformulated to obtain the column buckling load, P_{e2} , as

$$P_{e2} = \left(\frac{P_r}{\Sigma P_r} \right) \Sigma \frac{\pi^2 EI}{(K_{n2}L)^2} \leq 1.6 \frac{\pi^2 EI}{(K_{n2}L)^2} \quad (\text{C-A-7-9})$$

ΣP_r in Equations C-A-7-8 and C-A-7-9 includes all columns in the story, including any leaning columns, and P_r is for the column under consideration. The column buckling load, P_{e2} , calculated from Equation C-A-7-9 may be larger than $\pi^2 EI/L^2$ but may not be larger than the limit on the righthand side of this equation.

LeMessurier Approach: Another simple approach for the determination of K_2 (LeMessurier, 1995), based only on the column end moments, is:

$$K_2 = \left[1 + \left(1 - \frac{M_1}{M_2} \right)^4 \right] \sqrt{1 + \frac{5 \Sigma P_r \text{ leaning columns}}{6 \Sigma P_r \text{ nonleaning columns}}} \quad (\text{C-A-7-10})$$

In this equation, M_1 and M_2 are the smaller and larger end moments, respectively, in the column. These moments are determined from a first-order analysis of the frame under lateral load. Column inelasticity is considered in the derivation of this equation. The unconservative error in P_c using the above equation is less than 3%, as long as the following inequality is satisfied:

$$\left(\frac{\Sigma P_y \text{ nonleaning columns}}{\Sigma HL / \Delta_H} \right) \left(\frac{\Sigma P_r \text{ all columns}}{\Sigma P_r \text{ nonleaning columns}} \right) \leq 0.45 \quad (\text{C-A-7-11})$$

Some Conclusions Regarding K

Column design using K -factors can be tedious and confusing for complex building structures containing leaning columns and/or combined framing systems, particularly where column inelasticity is considered. This confusion can be avoided if the direct analysis method of Chapter C is used, where P_c is always based on $K = 1.0$. Also, the first-order analysis method of Appendix 7, Section 7.3 is based on the direct analysis method, and hence also uses $K = 1.0$ in the determination of P_c . Furthermore, under certain circumstances where $\Delta_{2\text{nd-order}}/\Delta_{1\text{st-order}}$ or B_2 is sufficiently low, $K = 1.0$ may be assumed in the effective length method as specified in Appendix 7, Section 7.2.3(b).

Comparison of the Effective Length Method and the Direct Analysis Method

Figure C-C2.5(a) shows a plot of the in-plane interaction equation for the effective length method, where the anchor point on the vertical axis, P_{nKL} , is determined using an effective length, KL . Also shown in this plot is the same interaction equation with the first term based on the yield load, P_y . For W-shapes, this in-plane beam-column interaction equation is a reasonable estimate of the internal force state associated with full cross-section plastification.

The P versus M response of a typical member, obtained from second-order spread-of-plasticity analysis and labeled “actual response,” indicates the maximum axial force, P_r , that the member can sustain prior to the onset of instability. The load-deflection response from a second-order elastic analysis using the nominal geometry and elastic stiffness, as conducted with the effective length method, is also shown. The “actual response” curve has larger moments than the above second-order elastic curve due to the combined effects of distributed yielding and geometric imperfections, which are not included in the second-order elastic analysis.

In the effective length method, the intersection of the second-order elastic analysis curve with the P_{nKL} interaction curve determines the member strength. The plot in Figure C-C2.5(a) shows that the effective length method is calibrated to give a resultant axial strength, P_c , consistent with the actual response. For slender columns, the calculation of the effective length, KL , (and P_{nKL}) is critical to achieving an accurate solution when using the effective length method.

One consequence of the procedure is that it underestimates the actual internal moments under the factored loads, as shown in Figure C-C2.5(a). This is inconsequential for the beam-column in-plane strength check since P_{nKL} reduces the effective strength in the correct proportion. However, the reduced moment can affect the design of the beams and connections, which provide rotational restraint to the column. This is of greatest concern when the calculated moments are small and axial loads are large, such that P - Δ moments induced by column out-of-plumbness can be significant.

The important difference between the direct analysis method and the effective length method is that where the former uses reduced stiffness in the analysis and $K = 1.0$ in the beam-column strength check, the latter uses nominal stiffness in the analysis and K from a sidesway buckling analysis in the beam-column strength check. The direct analysis method can be more sensitive to the accuracy of the second-order elastic analysis since analysis at reduced stiffness increases the magnitude of second-order effects. However, this difference is important only at high sidesway amplification levels; at those levels the accuracy of the calculation of K for the effective length method also becomes important.

7.3. FIRST-ORDER ANALYSIS METHOD

This section provides a method for designing frames using a first-order elastic analysis with $K = 1.0$, provided the limitations in Appendix 7, Section 7.3.1 are satisfied. This method is derived from the direct analysis method by mathematical manipulation (Kuchenbecker et al., 2004) so that the second-order internal forces and moments are determined directly as part of the first-order analysis. It is based upon a target maximum drift ratio, Δ/L , and assumptions, including:

- (1) The sidesway amplification $\Delta_{2nd\ order}/\Delta_{1st\ order}$ (or B_2) is assumed equal to 1.5.
- (2) The initial out-of-plumbness in the structure is assumed as $\Delta_o/L = 1/500$, but the initial out-of-plumbness does not need to be considered in the calculation of Δ .

The first-order analysis is performed using the nominal (unreduced) stiffness; stiffness reduction is accounted for solely within the calculation of the amplification factors. The nonsway amplification of beam-column moments is addressed within the procedure specified in this Section by applying the B_1 amplifier of Appendix 8, Section 8.2.1 conservatively to the total member moments. In many cases involving beam-columns not subject to transverse loading between supports in the plane of bending, $B_1 = 1.0$.

The target maximum drift ratio, corresponding to drifts under either the LRFD strength load combinations or 1.6 times the ASD strength load combinations, can

be assumed at the start of design to determine the additional lateral load, N_i . As long as that drift ratio is not exceeded at any strength load level, the design will be conservative.

Kuchenbecker et al. (2004) present a general form of this method. If the above approach is employed, it can be shown that for $B_2 \leq 1.5$ and $\tau_b = 1.0$ the required additional lateral load to be applied with other lateral loads in a first-order analysis of the structure, using the nominal (unreduced) stiffness, is:

$$N_i = \left(\frac{B_2}{1 - 0.2B_2} \right) \frac{\Delta}{L} Y_i \geq \left(\frac{B_2}{1 - 0.2B_2} \right) 0.002Y_i \quad (\text{C-A-7-12})$$

where these variables are as defined in Chapter C, Appendix 7 and Appendix 8. Note that if B_2 (based on the unreduced stiffness) is set to the 1.5 limit prescribed in Chapter C, then,

$$N_i = 2.1\alpha \left(\frac{\Delta}{L} \right) Y_i \geq 0.0042Y_i \quad (\text{C-A-7-13})$$

This is the additional lateral load required in Appendix 7, Section 7.3.2. The minimum value of N_i of $0.0042Y_i$ is based on the assumption of a minimum first-order drift ratio due to any effects of $\Delta/L = 1/500$.

APPENDIX 8

APPROXIMATE SECOND-ORDER ANALYSIS

Section C2.1(2) states that a second-order analysis that captures both P - Δ and P - δ effects is required. As an alternative to a rigorous second-order analysis, the amplification of first-order analysis forces and moments by the approximate procedure in this Appendix is permitted. The main approximation in this technique is that it evaluates P - Δ and P - δ effects separately, through separate multipliers B_2 and B_1 , respectively, considering the influence of P - δ effects on the overall response of the structure (which, in turn, influences P - Δ) only indirectly, through the factor R_M . A rigorous second-order elastic analysis is recommended for accurate determination of the frame internal forces when B_1 is larger than 1.2 in members that have a significant effect on the response of the overall structure.

This procedure uses a first-order elastic analysis with amplification factors that are applied to the first-order forces and moments so as to obtain an estimate of the second-order forces and moments. In the general case, a member may have first-order load effects not associated with *sidesway* that are multiplied by a factor B_1 , and first-order load effects produced by *sidesway* that are multiplied by a factor B_2 . The factor B_1 estimates the P - δ effects on the nonsway moments in compression members. The factor B_2 estimates the P - Δ effects on the forces and moments in all members. These effects are shown graphically in Figures C-C2.1 and C-A-8.1.

The factor B_2 applies only to internal forces associated with *sidesway* and is calculated for an entire story. In building frames designed to limit Δ_H/L to a predetermined value, the factor B_2 may be found in advance of designing individual members by using the target

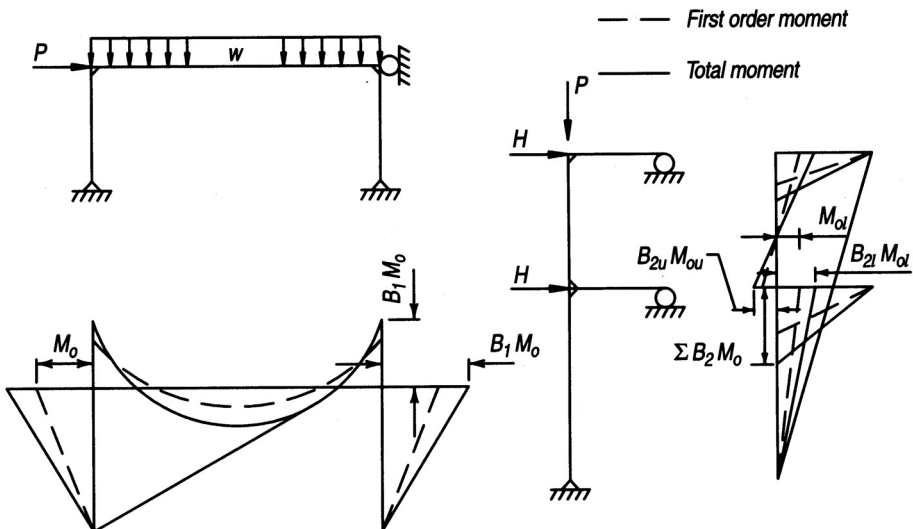

Fig. C-A-8.1. Moment amplification.

maximum limit on Δ_H/L within Equation A-8-7. Drift limits may also be set for design of various categories of buildings so that the effect of secondary bending is reduced (ATC, 1978; Kanchanalai and Lu, 1979). However, drift limits alone are not sufficient to allow stability effects to be neglected (LeMessurier, 1977).

In determining B_2 and the second-order effects on the lateral load resisting system, it is important that Δ_H include not only the interstory displacement in the plane of the lateral load resisting system, but also any additional displacement in the floor or roof diaphragm or horizontal framing system that may increase the overturning effect of columns attached to and “leaning” against the horizontal system. Either the maximum displacement or a weighted average displacement, weighted in proportion to column load, should be considered.

The current Specification provides only one equation (Equation A-8-7) for determining the elastic buckling strength of a story; this formula is based on the lateral stiffness of the story as determined from a first-order analysis and is applicable to all buildings. The 2005 AISC *Specification for Structural Steel Buildings* (AISC, 2005a) offered a second formula (Equation C2-6a in that edition), based on the lateral buckling strength of individual columns, applicable only to buildings in which lateral stiffness is provided entirely by moment frames. That equation is:

$$\Sigma P_{e2} = \Sigma \frac{\pi^2 EI}{(K_2 L)^2} \quad (\text{C-A-8-1})$$

where

ΣP_{e2} = elastic buckling strength of the story, kips (N)

L = story height, in. (mm)

K_2 = effective length factor in the plane of bending, calculated from a *sidesway buckling* analysis

This equation for the story elastic buckling strength was eliminated from the 2010 Specification because of its limited applicability, the difficulty involved in calculating K_2 correctly, and the greater ease of application of the story stiffness-based formula. Additionally, with the deletion of this equation, the symbol ΣP_{e2} was changed to $P_{e \text{ story}}$ since the story buckling strength is not the summation of the strengths of individual columns, as implied by the earlier symbol.

First-order member forces and moments with the structure restrained against sidesway are labeled P_{nt} and M_{nt} ; the first-order effects of lateral translation are labeled P_{lt} and M_{lt} . For structures where gravity load causes negligible lateral translation, P_{nt} and M_{nt} are the effects of gravity load and P_{lt} and M_{lt} are the effects of lateral load. In the general case, P_{nt} and M_{nt} are the results of an analysis with the structure restrained against sidesway; P_{lt} and M_{lt} are from an analysis with the lateral reactions from the first analysis (as used to find P_{nt} and M_{nt}) applied as lateral loads. Algebraic addition of the two sets of forces and moments after application of multipliers B_1 and B_2 as specified in Equations A-8-1 and A-8-2 gives reasonably accurate values of the overall second-order forces and moments.

The B_2 multiplier is applicable to forces and moments P_{lt} and M_{lt} in all members (including beams, columns, bracing diagonals and shear walls) that participate in resisting lateral load. P_{lt} and M_{lt} will be zero in members that do not participate in resisting lateral load;

hence B_2 will have no effect on them. The B_1 multiplier is applicable only to compression members.

If B_2 for a particular direction of translation does not vary significantly among the stories of a building, it will be convenient to use the maximum value for all stories, leading to just two B_2 values, one for each direction, for the entire building. Where B_2 does vary significantly between stories, the multiplier for beams between stories should be the larger value.

When first-order end moments in columns are magnified by B_1 and B_2 factors, equilibrium requires that they be balanced by moments in the beams that connect to them (for example, see Figure C-A-8.1). The B_2 multiplier does not cause any difficulty in this regard, since it is applied to all members. The B_1 multiplier, however, is applied only to compression members; the associated second-order internal moments in the connected members can be accounted for by amplifying the moments in those members by the B_1 value of the compression member (using the largest B_1 value if there are two or more compression members at the joint). Alternatively, the difference between the magnified moment (considering B_1 only) and the first-order moment in the compression member(s) at a given joint may be distributed to any other moment-resisting members attached to the compression member (or members) in proportion to the relative stiffness of those members. Minor imbalances may be neglected, based upon engineering judgment. Complex conditions may be treated more expediently with a rigorous second-order analysis.

In braced frames and moment frames, P_c is governed by the maximum slenderness ratio regardless of the plane of bending, if the member is subject to significant *biaxial bending*, or the provisions in Section H1.3 are not utilized. Section H1.3 is an alternative approach for checking beam-column strength that provides for the separate checking of beam-column in-plane and out-of-plane stability in members predominantly subject to bending within the plane of the frame. However, P_{e1} expressed by Equation A-8-5 is always calculated using the slenderness ratio in the plane of bending. Thus, when flexure in a beam-column is about the strong axis only, two different values of slenderness ratio may be involved in the amplified first-order elastic analysis and strength check calculations.

The factor R_M in Equation A-8-7 accounts for the influence of $P-\delta$ effects on sidesway amplification. R_M can be taken as 0.85 as a lower bound value for stories that include moment frames (LeMessurier, 1977); $R_M = 1$ if there are no moment frames in the story. Equation A-8-8 can be used for greater precision between these extreme values.

Second-order internal forces from separate structural analyses cannot normally be combined by superposition since second-order amplification is a nonlinear effect based on the total axial forces within the structure; therefore, a separate analysis must be conducted for each load combination considered in the design. However, in the amplified first-order elastic analysis procedure of Appendix 8, the first-order internal forces, calculated prior to amplification may be superimposed to determine the total first-order internal forces.

Coefficient C_m and Effective Length Factor K

Equations A-8-3 and A-8-4 are used to approximate the maximum second-order moments in compression members with no relative joint translation and no transverse loads between the ends of the member. Figure C-A-8.2 compares the approximation for C_m in Equation A-8-4 to the exact theoretical solution for beam-columns subjected to applied end moments

(Chen and Lui, 1987). The approximate and analytical values of C_m are plotted versus the end-moment ratio M_1/M_2 for several values of P/P_e ($P_e = P_{e1}$ with $K = 1$). The corresponding approximate and analytical solutions are shown in Figure C-A-8.3 for the maximum second-order elastic moment within the member, M_r , versus the axial load level, P/P_e , for several values of the end moment ratio, M_1/M_2 .

For beam-columns with transverse loadings, the second-order moment can be approximated for simply supported members with

$$C_m = 1 + \Psi \left(\frac{\alpha P_r}{P_{e1}} \right) \tag{C-A-8-2}$$

where

$$\Psi = \frac{\pi^2 \delta_o EI}{M_o L^2} - 1 \tag{C-A-8-3}$$

δ_o = maximum deflection due to transverse loading, in. (mm)

M_o = maximum first-order moment within the member due to the transverse loading, kip-in. (N-mm)

α = 1.0 (LRFD) or 1.6 (ASD)

For restrained ends, some limiting cases are given in Table C-A-8.1 together with two cases of simply supported beam-columns (Iwankiw, 1984). These values of C_m are always

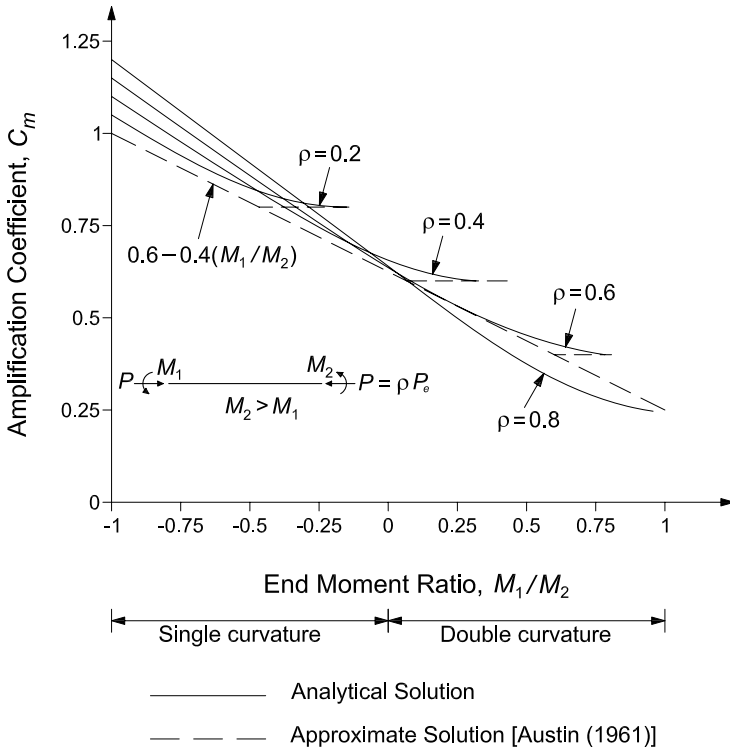

Fig. C-A-8.2. Equivalent moment factor, C_m , for beam-columns subjected to applied end moments.

used with the maximum moment in the member. For the restrained-end cases, the values of B_1 are most accurate if values of $K < 1.0$, corresponding to the member end conditions, are used in calculating P_{e1} .

In lieu of using the equations above, the use of $C_m = 1.0$ is conservative for all transversely loaded members. It can be shown that the use of $C_m = 0.85$ for members with restrained ends, specified in previous Specifications, can sometimes result in a significant underestimation of the internal moments. Therefore, the use of $C_m = 1.0$ is recommended as a simple conservative approximation for all cases involving transversely loaded members.

In second-order analysis by amplification of the results of first-order analysis, the effective length factor, K , is used in the determination of the elastic critical buckling load, P_{e1} , for a member. This elastic critical buckling load is then used for calculation of the corresponding amplification factor B_1 .

B_1 is used to estimate the $P-\delta$ effects on the nonsway moments, M_m , in compression members. K_1 is calculated in the plane of bending on the basis of no translation of the ends of the member and is normally set to 1.0, unless a smaller value is justified on the basis of analysis.

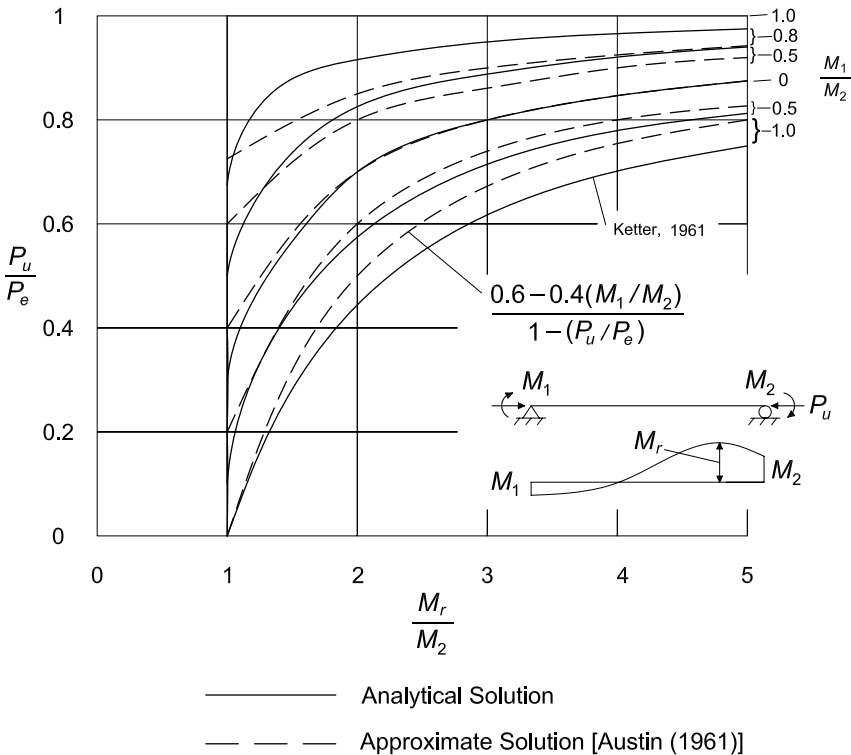
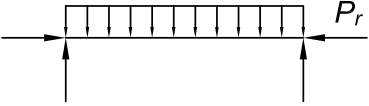
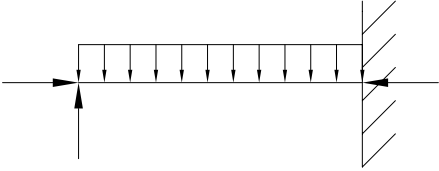
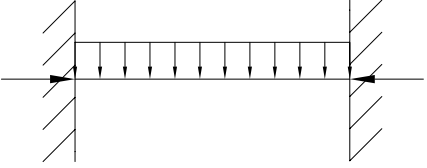
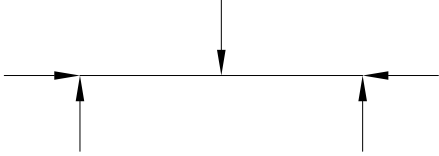
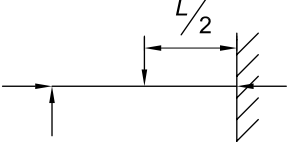
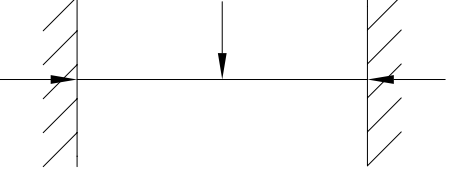

Fig. C-A-8.3. Maximum second-order moments, M_r , for beam-columns subjected to applied end moments.

TABLE C-A-8.1
Amplification Factors ψ and C_m

Case	ψ	C_m
	0	1.0
	-0.4	$1 - 0.4 \frac{\alpha P_r}{P_{e1}}$
	-0.4	$1 - 0.4 \frac{\alpha P_r}{P_{e1}}$
	-0.2	$1 - 0.2 \frac{\alpha P_r}{P_{e1}}$
	-0.3	$1 - 0.3 \frac{\alpha P_r}{P_{e1}}$
	-0.2	$1 - 0.2 \frac{\alpha P_r}{P_{e1}}$

Since the amplified first-order elastic analysis involves the calculation of elastic buckling loads as a measure of frame and column stiffness, only elastic K factors are appropriate for this use.

Summary—Application of Multipliers B_1 and B_2

There is a single B_2 value for each story and each direction of lateral translation of the story, say B_{2X} and B_{2Y} for the two global directions. Multiplier B_{2X} is applicable to all axial and shear forces and moments produced by story translation in the global X direction. Thus, in the common case where gravity load produces no lateral translation and all X translation is the result of lateral load in the X direction, B_{2X} is applicable to all axial forces and moments produced by lateral load in the global X direction. Similarly, B_{2Y} is applicable in the Y direction.

Note that B_{2X} and B_{2Y} are associated with global axes X and Y and the direction of story translation or loading, but are completely unrelated to the direction of bending of individual members. Thus, for example, if lateral load or translation in the global X direction causes moments M_x and M_y about member axes x and y in a particular member, B_{2X} must be applied to both M_x and M_y .

There is a separate B_1 value for every member subject to compression and flexure and each direction of bending of the member, say B_{1x} and B_{1y} for the two member axes. Multiplier B_{1x} is applicable to the member x -axis moment, regardless of the load that causes that moment. Similarly, B_{1y} is applicable to the member y -axis moment, regardless of the load that causes that moment.

REFERENCES

- AASHTO (2002), *Standard Specifications for Highway Bridges*, 17th Ed., American Association of State Highway and Transportation Officials, Washington, DC.
- AASHTO (2010), *LRFD Bridge Design Specifications*, 5th Ed., American Association of State Highway and Transportation Officials, Washington, DC.
- ACI (1997), *Prediction of Creep, Shrinkage and Temperature Effects in Concrete Structures*, ACI 209R-92, American Concrete Institute, Farmington Hills, MI.
- ACI (2001), *Code Requirements for Nuclear Safety Related Concrete Structures*, ACI 349-01, American Concrete Institute, Farmington Hills, MI.
- ACI (2002), *Building Code Requirements for Structural Concrete*, ACI 318-02 and ACI 318M-02, American Concrete Institute, Farmington Hills, MI.
- ACI (2005), *Specification for Structural Concrete*, ACI 301-05, American Concrete Institute, Farmington Hills, MI.
- ACI (2006), *Specifications for Tolerances for Concrete Construction and Materials*, ACI 117-06, American Concrete Institute, Farmington Hills, MI.
- ACI (2008), *Building Code Requirements for Structural Concrete*, ACI 318-08 and ACI 318M-08, American Concrete Institute, Farmington Hills, MI.
- AISC (1969), *Specification for the Design, Fabrication, and Erection of Structural Steel for Buildings*, American Institute of Steel Construction, Chicago, IL.
- AISC (1973), "Commentary on Highly Restrained Welded Connections," *Engineering Journal*, American Institute of Steel Construction, Vol. 10, No. 3, 3rd Quarter, pp. 61-73.
- AISC (1975), *Australian Standard AS1250*, Australian Institute of Steel Construction, Sydney, Australia.
- AISC (1978), *Specification for the Design, Fabrication, and Erection of Structural Steel for Buildings*, American Institute of Steel Construction, Chicago, IL.
- AISC (1986), *Load and Resistance Factor Design Specification for Structural Steel Buildings*, American Institute of Steel Construction, Chicago, IL.
- AISC (1989), *Specification for Structural Steel Buildings—Allowable Stress Design and Plastic Design*, American Institute of Steel Construction, Chicago, IL.
- AISC (1993), *Load and Resistance Factor Design Specification for Structural Steel Buildings*, American Institute of Steel Construction, Chicago, IL.
- AISC (1997a), *A Guide to Engineering and Quality Criteria for Steel Structures*, American Institute of Steel Construction, Chicago, IL.
- AISC (1997b), "AISC Advisory Statement on Mechanical Properties Near the Fillet of Wide Flange Shapes and Interim Recommendations, January 10, 1997," *Modern Steel Construction*, American Institute of Steel Construction, Chicago, IL, February, p. 18.

- AISC (2000a), *Specification for the Design of Steel Hollow Structural Sections*, American Institute of Steel Construction, Chicago, IL.
- AISC (2000b), *Load and Resistance Factor Design Specification for Structural Steel Buildings*, December 27, 1999, American Institute of Steel Construction, Chicago, IL.
- AISC (2005a), *Specification for Structural Steel Buildings*, ANSI/AISC 360-05, American Institute of Steel Construction, Chicago, IL.
- AISC (2005b), *Steel Construction Manual*, 13th Ed., American Institute of Steel Construction, Chicago, IL.
- AISC (2005c), *Design Examples*, V13.1, www.aisc.org.
- AISC (2006a), *Seismic Design Manual*, American Institute of Steel Construction, Chicago, IL.
- AISC (2006b), *Standard for Steel Building Structures*, AISC 201-06, Certification Program for Structural Steel Fabricators, American Institute of Steel Construction, Chicago, IL.
- AISC (2010a), *Code of Standard Practice for Steel Buildings and Bridges*, AISC 303-10, American Institute of Steel Construction, Chicago, IL.
- AISC (2010b), *Seismic Provisions for Structural Buildings*, American Institute of Steel Construction, Chicago, IL.
- AISC-SSRC (2003a), "Basic Design for Stability: Lecture 3—Frame Stability—Alignment Charts and Modifications," American Institute of Steel Construction and Structural Stability Research Council, Chicago, IL.
- AISC-SSRC (2003b), "Background and Illustrative Examples on Proposed Direct Analysis Method for Stability Design of Moment Frames," Technical White Paper, AISC Technical Committee 10, AISC-SSRC Ad Hoc Committee on Frame Stability, American Institute of Steel Construction, Chicago, IL.
- AISI (1969), *Specification for the Design of Cold-Formed Steel Structural Members*, American Iron and Steel Institute, Washington, DC.
- AISI (1970), "Interior Corrosion of Structural Steel Closed Sections," Bulletin 18, February, American Iron and Steel Institute, Washington, DC.
- AISI (1979), *Fire-Safe Structural Design A Design Guide*, American Iron and Steel Institute, Washington, DC.
- AISI (2001), *North American Specification for the Design of Cold-Formed Steel Structural Members*, American Iron and Steel Institute, Washington, DC.
- AISI (2007), *North American Specification for the Design of Cold-Formed Steel Structural Members*, ANSI/AISI Standard S100 2007, Washington, DC.
- Allan, R.N. and Fisher, J.W. (1968), "Bolted Joints with Oversize and Slotted Holes," *Journal of the Structural Division*, ASCE, Vol. 94, No. ST9, September, pp. 2061–2080.
- Amrine, J.J. and Swanson, J.A. (2004), "Effects of Variable Pretension on Bolted Connection Behavior," *Engineering Journal*, AISC, Vol. 41, No. 3, 3rd Quarter, pp. 107–116.

- Ang, A.H-S. and Tang, H.T. (1984), *Probability Concepts in Engineering Planning and Design, Vol.II: Decision, Risk and Reliability*, John Wiley & Sons Inc., New York, NY.
- Ang, K.M. and Morris, G.A. (1984), "Analysis of Three-Dimensional Frames with Flexible Beam-Column Connections," *Canadian Journal of Civil Engineering*, Vol. 11, No. 2, pp. 245-254.
- API (1993), *Recommended Practice for Planning, Designing and Constructing Fixed Offshore Platforms—Load and Resistance Factor Design*, 1st Ed., American Petroleum Institute, Washington, DC, July.
- ASCE (1971), *Plastic Design in Steel, A Guide and a Commentary*, ASCE Manuals and Reports on Engineering Practice No. 41, American Society of Civil Engineers, New York, NY.
- ASCE (1979), *Structural Design of Tall Steel Buildings*, American Society of Civil Engineers, New York, NY.
- ASCE (1981), "Planning and Environmental Criteria for Tall Buildings, A Monograph on Planning and Design of Tall Buildings," Vol. PC, Chapter PC-13, American Society of Civil Engineers, New York, NY.
- ASCE (1999), *Specification for Structural Steel Beams with Web Openings*, ASCE/SEI 23-97, American Society of Civil Engineers, Reston, VA.
- ASCE (2000), *Design of Latticed Steel Transmission Structures*, ASCE 10-97, American Society of Civil Engineers, Reston, VA.
- ASCE (2003), *Seismic Evaluation of Existing Buildings*, ASCE/SEI 31-03, American Society of Civil Engineers, Reston, VA.
- ASCE (2005a), *Standard Calculation Methods for Structural Fire Protection*, ASCE/SEI/SFPE 29-05, American Society of Civil Engineers, Reston, VA.
- ASCE (2005b), *Minimum Design Loads for Buildings and Other Structures*, ASCE/SEI 7-05, American Society of Civil Engineers, Reston, VA.
- ASCE (2006), *Seismic Rehabilitation of Existing Buildings*, ASCE/SEI 41-06, American Society of Civil Engineers, Reston, VA.
- ASCE (2008), *Standard Calculation Methods for Structural Fire Protection*, ASCE/SEI/SFPE 29-08, American Society of Civil Engineers, Reston, VA.
- ASCE (2010), *Minimum Design Loads for Buildings and Other Structures*, ASCE/SEI 7-10, American Society of Civil Engineers, Reston, VA.
- ASCE Task Committee on Design Criteria for Composite Structures in Steel and Concrete (1992a), "Proposed Specification for Structural Steel Beams with Web Openings," *Journal of Structural Engineering*, ASCE, Vol. 118, No. ST12, December, pp. 3,315-3,324.
- ASCE Task Committee on Design Criteria for Composite Structures in Steel and Concrete (1992b), "Commentary on Proposed Specification for Structural Steel Beams with Web Openings," *Journal of Structural Engineering*, ASCE, Vol. 118, No. ST12, December, pp. 3,325-3,349.

- ASCE Task Committee on Drift Control of Steel Building Structures (1988), "Wind Drift Design of Steel-Framed Buildings: State of the Art," *Journal of the Structural Division*, ASCE, Vol. 114, No. 9, pp. 2,085-2,108.
- ASCE Task Committee on Effective Length (1997), *Effective Length and Notional Load Approaches for Assessing Frame Stability: Implications for American Steel Design*, American Society of Civil Engineers, New York, NY.
- Aslani, F. and Goel, S.C. (1991), "An Analytical Criteria for Buckling Strength of Built-Up Compression Members," *Engineering Journal*, AISC, Vol. 28, No. 4, 4th Quarter, pp. 159-168.
- ASNT (2006a), *Personnel Qualification and Certification in Nondestructive Testing*, ASNT SNT-TC-1A-2003, American Society of Nondestructive Testing, Columbus, OH.
- ASNT (2006b), *Standard for Qualification and Certification of Nondestructive Testing Personnel*, ANSI/ASNT CP-189-2006, American Society of Nondestructive Testing, Columbus, OH.
- ASTM (2006), *Standard Test Methods for Determining Effects of Large Hydrocarbon Pool Fires on Structural Members and Assemblies*, ASTM E1529-06, American Society for Testing and Materials, West Conshohocken, PA.
- ASTM (2007a), *Standard Practice for Safeguarding Against Warpage and Distortion During Hot-Dip Galvanizing of Steel Assemblies*, ASTM A384/A384M-07, American Society for Testing and Materials, West Conshohocken, PA.
- ASTM (2007b), *Standard Practice for Castings, Carbon, Low-Alloy, and Martensitic Stainless Steel, Ultrasonic Examination Thereof*, ASTM A609/A609M-91(2007), American Society for Testing and Materials, West Conshohocken, PA.
- ASTM (2007c), *Standard Specification for Carbon Steel Bolts and Studs, 60 000 PSI Tensile Strength*, ASTM A307-07b, American Society for Testing and Materials, West Conshohocken, PA.
- ASTM (2007d), *Standard Specification for Cold-Formed Welded and Seamless Carbon Steel Structural Tubing in Rounds and Shapes*, ASTM A500/A500M-07, American Society for Testing and Materials, West Conshohocken, PA.
- ASTM (2009a), *Standard Specification for Zinc Coating (Hot-Dip) on Iron and Steel Hardware*, ASTM A153/153M-09, American Society for Testing and Materials, West Conshohocken, PA.
- ASTM (2009b), *Standard Practice for Providing High-Quality Zinc Coatings (Hot-Dip)*, ASTM A385/A385M-09, American Society for Testing and Materials, West Conshohocken, PA.
- ASTM (2009c), *Standard Practice for Repair of Damaged and Uncoated Areas of Hot-Dip Galvanized Coatings*, ASTM A780/A780M-09, American Society for Testing and Materials, West Conshohocken, PA.
- ASTM (2009d), *Standard Test Methods for Fire Tests of Building Construction and Materials*, ASTM E119-09c, American Society for Testing and Materials, West Conshohocken, PA.

- ASTM (2009e), *Standard Specification for Zinc (Hot-Dip Galvanized) Coatings on Iron and Steel Products*, ASTM A123/A123M-09, American Society for Testing and Materials, West Conshohocken, PA.
- ATC (1978), "Tentative Provisions for the Development of Seismic Regulations for Buildings," Publication 3-06, Applied Technology Council, Redwood City, CA, June.
- Austin, W.J. (1961), "Strength and Design of Metal Beam-Columns," *Journal of the Structural Division*, ASCE, Vol. 87, No. ST4, April, pp. 1-32.
- AWS (1977), *Criteria for Describing Oxygen-Cut Surfaces*, AWS C4.1-77, American Welding Society, Miami, FL.
- AWS (2003), *Specification For The Qualification Of Welding Inspectors*, AWS B5.1:03, American Welding Society, Miami, FL.
- AWS (2010), *Structural Welding Code—Steel*, AWS D1.1/D1.1M:2010, American Welding Society, Miami, FL.
- Bartlett, R.M., Dexter, R.J., Graeser, M.D., Jelinek, J.J., Schmidt, B.J. and Galambos, T.V. (2003), "Updating Standard Shape Material Properties Database for Design and Reliability," *Engineering Journal*, AISC, Vol. 40, No. 1, pp. 2-14.
- Basler, K. (1961), "Strength of Plate Girders in Shear," *Journal of the Structural Division*, ASCE, Vol. 104, No. ST9, October, pp. 151-180.
- Basler, K., Yen, B.T., Mueller, J.A. and Thürlimann, B. (1960), "Web Buckling Tests on Welded Plate Girders," *Welding Research Council Bulletin No. 64*, September, New York, NY.
- Basler, K. and Thürlimann, B. (1963), "Strength of Plate Girders in Bending," *Transactions of the American Society of Civil Engineers*, Vol. 128, Part II, pp. 655-682.
- Bathe, K. (1995), *Finite Element Procedures*, Prentice-Hall, Upper Saddle River, NJ.
- Beedle, L.S. (1958), *Plastic Design of Steel Frames*, John Wiley & Sons Inc., New York, NY.
- Bigos, J., Smith, G.W., Ball, E.F. and Foehl, P.J. (1954), "Shop Paint and Painting Practice," *Proceedings of AISC National Engineering Conference*, Milwaukee, WI, American Institute of Steel Construction, Chicago, IL.
- Bijlaard, F.S.K., Gresnigt, A.M. and van der Vegte, G.J. (eds.) (2005), *Connections in Steel Structures V*, Bouwen met Staal, Delft, the Netherlands.
- Birkemoe, P.C. and Gilmor, M.I. (1978), "Behavior of Bearing-Critical Double-Angle Beam Connections," *Engineering Journal*, AISC, Vol. 15, No. 4, 4th Quarter, pp. 109-115.
- Birnstiel, C. and Iffland, J.S.B. (1980), "Factors Influencing Frame Stability," *Journal of the Structural Division*, ASCE, Vol. 106, No. 2, pp. 491-504.
- Bjorhovde, R. (1972), "Deterministic and Probabilistic Approaches to the Strength of Steel Columns," Ph.D. Dissertation, Lehigh University, Bethlehem, PA, May.
- Bjorhovde, R. (1978), "The Safety of Steel Columns," *Journal of the Structural Division*, ASCE, Vol. 104, No. ST9, September, pp. 1371-1387.
- Bjorhovde, R. and Birkemoe, P.C. (1979), "Limit States Design of HSS Columns," *Canadian Journal of Civil Engineering*, Vol. 6, No. 2, pp. 276-291.

- Bjorhovde, R., Brozzetti, J. and Colson, A. (eds.) (1988), *Connections in Steel Structures: Behaviour, Strength and Design*, Elsevier Applied Science, London, England.
- Bjorhovde, R. (1988), "Columns: From Theory to Practice," *Engineering Journal*, AISC, Vol. 25, No. 1, 1st Quarter, pp. 21–34.
- Bjorhovde, R., Colson, A. and Brozzetti, J. (1990), "Classification System for Beam-to-Column Connections," *Journal of Structural Engineering*, ASCE, Vol. 116, No. 11, pp. 3,059–3,076.
- Bjorhovde, R., Colson, A., Haaijer, G. and Stark, J.W.B. (eds.) (1992), *Connections in Steel Structures II: Behavior, Strength and Design*, American Institute of Steel Construction, Chicago, IL.
- Bjorhovde, R., Colson, A. and Zandonini, R. (eds.) (1996), *Connections in Steel Structures III: Behaviour, Strength and Design*, Pergamon Press, London, England.
- Bjorhovde, R., Goland, L.J. and Benac, D.J. (1999), "Tests of Full-Scale Beam-to-Column Connections," Southwest Research Institute, San Antonio, TX and Nucor-Yamato Steel Company, Blytheville, AR.
- Bjorhovde, R. (2006), "Cold Bending of Wide-Flange Shapes for Construction," *Engineering Journal*, AISC, Vol. 43, No. 4, 4th Quarter, pp. 271–286.
- Bjorhovde, R., Bijlaard, F.S.K. and Geschwindner, L.F. (eds.) (2008), *Connections in Steel Structures VI*, AISC, Chicago, IL.
- Bleich, F. (1952), *Buckling Strength of Metal Structures*, McGraw-Hill, New York, NY.
- Blodgett, O.W. (1967), "The Question of Corrosion in Hollow Steel Sections," *Welding Design Studies in Steel Structures*, Lincoln Electric Company, D610.163, August, Cleveland, OH.
- Borello, D.J., Denavit, M.D. and Hajjar, J.F. (2009), "Behavior of Bolted Steel Slip-Critical Connections with Fillers," Report No. NSEL-017, Department of Civil and Environmental Engineering, University of Illinois at Urbana-Champaign, Urbana, IL, August.
- Bradford, M.A., Wright, H.D. and Uy, B. (1998), "Local Buckling of the Steel Skin in Lightweight Composites Induced by Creep and Shrinkage," *Advances in Structural Engineering*, Vol. 2, No. 1, pp. 25–34.
- Bradford, M.A., Loh, H.Y. and Uy, B. (2002), "Slenderness Limits for Filled Circular Steel Tubes," *Journal of Constructional Steel Research*, Vol. 58, No. 2, pp. 243–252.
- Brandt, G.D. (1982), "A General Solution for Eccentric Loads on Weld Groups," *Engineering Journal*, AISC, Vol. 19, No. 3, 3rd Quarter, pp. 150–159.
- Bridge, R.Q. (1998), "The Inclusion of Imperfections in Probability-Based Limit States Design," *Proceedings of the 1998 Structural Engineering World Congress*, San Francisco, CA, July.
- Bridge, R.Q. and Bizzanelli, P. (1997), Imperfections in Steel Structures, *Proceedings—1997 Annual Technical Session, and Meeting*, Structural Stability Research Council, pp. 447–458.

- Brockenbrough, R.B. and Johnston, B.G. (1981), *USS Steel Design Manual*, United States Steel Corporation, Pittsburgh, PA.
- Brockenbrough, R.L. (1983), "Considerations in the Design of Bolted Joints for Weathering Steel," *Engineering Journal*, AISC, Vol. 20, No. 1, 1st Quarter, pp. 40-45.
- Brosnan, D.P. and Uang, C.M. (1995), "Effective Width of Composite L-Beams in Buildings," *Engineering Journal*, AISC, Vol. 30, No. 2, 2nd Quarter, pp. 73-81.
- Bruneau, M., Uang, C.-M. and Whittaker, A. (1998), *Ductile Design of Steel Structures*, McGraw Hill, New York, NY.
- BSSC (2003), *NEHRP Recommended Provisions for Seismic Regulations for New Buildings and Other Structures*, FEMA 450-1, Building Seismic Safety Council, Washington, DC.
- BSSC (2009), *NEHRP Recommended Seismic Provisions for New Buildings and Other Structures*, FEMA P-750, Building Seismic Safety Council, Washington, DC.
- Buonopane, S.G. and Schafer, B.W. (2006), "Reliability of Steel Frames Designed with Advanced Analysis," *Journal of Structural Engineering*, ASCE, Vol. 132, No. 2, pp. 267-276.
- Butler, L.J., Pal, S. and Kulak, G.L. (1972), "Eccentrically Loaded Welded Connections," *Journal of the Structural Division*, ASCE, Vol. 98, No. ST5, May, pp. 989-1,005.
- Carter, C.J., Tide, R.H. and Yura, J.A. (1997), "A Summary of Changes and Derivation of LRFD Bolt Design Provisions," *Engineering Journal*, AISC, Vol. 34, No. 3, 3rd Quarter, pp. 75-81.
- Carter, C.J. (1999), *Stiffening of Wide-Flange Columns at Moment Connections: Wind and Seismic Applications*, Design Guide 13, AISC, Chicago, IL.
- CEN (1991), *Eurocode 1: Basis of Design and Actions on Structures*, EC1 1991-2-2, Comite Européen de Normalisation, Brussels, Belgium.
- CEN (2003), *Eurocode 4: Design of Composite Steel and Concrete Structures*, Comite Européen de Normalisation, Brussels, Belgium.
- CEN (2005), *Eurocode 3: Design of Steel Structures*, Comite Européen de Normalisation, Brussels, Belgium.
- Charney, F.A. (1990), "Wind Drift Serviceability Limit State Design of Multi-story Buildings," *Journal of Wind Engineering and Industrial Aerodynamics*, Vol. 36, pp. 203-212.
- Chen, W.F. and Kim, S.E. (1997), *LRFD Steel Design Using Advanced Analysis*, CRC Press, Boca Raton, FL.
- Chen, P.W. and Robertson, L.E. (1972), "Human Perception Thresholds of Horizontal Motion," *Journal of the Structural Division*, ASCE, Vol. 98, No. ST8, August, pp. 1681-1695.
- Chen, S. and Tong, G. (1994), "Design for Stability: Correct Use of Braces," *Steel Structures*, Journal of the Singapore Structural Steel Society, Vol. 5, No. 1, December, pp. 15-23.

- Chen, W.F. and Atsuta, T. (1976), *Theory of Beam-Columns, Volume I: In-Plane Behavior and Design*, and *Volume II: Space Behavior and Design*, McGraw-Hill, New York, NY.
- Chen, W.F. and Atsuta, T. (1977), *Theory of Beam Columns, Volume II: Space Behavior and Design*, McGraw-Hill, New York, NY.
- Chen, W.F. and Lui, E.M. (1987), *Structural Stability: Theory and Implementation*, Elsevier, New York, NY.
- Chen, W.F. and Lui, E.M. (1991), *Stability Design of Steel Frames*, CRC Press, Boca Raton, FL.
- Chen, W.F. and Toma, S. (eds.) (1994), *Advanced Analysis of Steel Frames: Theory, Software and Applications*, CRC Press, Boca Raton, FL.
- Chen, W.F. and Sohal, I. (1995), *Plastic Design and Second-Order Analysis of Steel Frames*, Springer Verlag, New York, NY.
- Chen, W.F., Goto, Y. and Liew, J.Y.R. (1995), *Stability Design of Semi-Rigid Frames*, John Wiley & Sons, Inc., New York, NY.
- Cheng, J.J.R. and Kulak, G.L. (2000), "Gusset Plate Connection to Round HSS Tension Members," *Engineering Journal*, AISC, Vol. 37, No. 4, 4th Quarter, pp. 133–139.
- Chien, E.Y.L. and Ritchie, J.K. (1984), *Composite Floor Systems*, Canadian Institute of Steel Construction, Willowdale, Ontario, Canada.
- Clarke, M.J., Bridge, R.Q., Hancock, G.J. and Trahair, N.S. (1992), "Advanced Analysis of Steel Building Frames," *Journal of Constructional Steel Research*, Vol. 23, No. 1–3, pp. 1–29.
- Cooke, G.M.E. (1988), "An Introduction to the Mechanical Properties of Structural Steel at Elevated Temperatures," *Fire Safety Journal*, Vol. 13, pp. 45–54.
- Cooney, R.C. and King, A.B. (1988), "Serviceability Criteria for Buildings," BRANZ Report SR14, Building Research Association of New Zealand, Porirua, New Zealand.
- Cooper, P.B., Galambos, T.V. and Ravindra, M.K. (1978), "LRFD Criteria for Plate Girders," *Journal of the Structural Division*, ASCE, Vol. 104, No. ST9, September, pp. 1389–1407.
- Crisfield, M.A. (1991), *Nonlinear Finite Element Analysis of Solids and Structures*, John Wiley & Sons, Inc., NY.
- CSA (2004), *General Requirements for Rolled or Welded Structural Quality Steel/Structural Quality Steel*, CAN/CSA-G40.20/G40.21-04, Canadian Standards Association, Mississauga, Ontario, Canada.
- CSA (2009), *Limit States Design of Steel Structures*, CSA Standard S16-09, Canadian Standards Association, Rexdale, Ontario, Canada
- Darwin, D. (1990), *Steel and Composite Beams with Web Openings*, Design Guide 2, AISC, Chicago, IL.

- Davies, G. and Packer, J.A. (1982), "Predicting the Strength of Branch Plate—RHS Connections for Punching Shear," *Canadian Journal of Civil Engineering*, Vol. 9, pp. 458–467.
- Dekker, N.W., Kemp, A.R. and Trincherro, P. (1995), "Factors Influencing the Strength of Continuous Composite Beams in Negative Bending," *Journal of Constructional Steel Research*, Vol. 34, Nos. 2–3, pp. 161–185.
- Dexter, R.J. and Melendrez, M.I. (2000), "Through-Thickness Properties of Column Flanges in Welded Moment Connections," *Journal of Structural Engineering*, ASCE, Vol. 126, No. 1, pp. 24–31.
- Dexter, R.J., Hajjar, J.F., Prochnow, S.D., Graeser, M.D., Galambos, T.V. and Cotton, S.C. (2001), "Evaluation of the Design Requirements for Column Stiffeners and Doublers and the Variation in Properties of A992 Shapes," *Proceedings of the North American Steel Construction Conference*, Fort Lauderdale, FL, May 9-12, 2001, AISC, Chicago, IL, pp. 14.1–14.21.
- Dexter, R.J. and Altstadt, S.A. (2004), "Strength and Ductility of Tension Flanges in Girders," *Recent Developments in Bridge Engineering, Proceedings of the Second New York City Bridge Conference*, October 20-21, 2003, New York, NY, Mahmoud, K.M. (ed.), A.A. Balkema/Swets & Zeitlinger, Lisse, the Netherlands, pp. 67–81.
- Disque, R.O. (1964), "Wind Connections with Simple Framing," *Engineering Journal*, AISC, Vol. 1, No. 3, July, pp. 101-103.
- Dusicka, P. and Iwai, R. (2007), "Development of Linked Column Frame Lateral Load Resisting System," 2nd Progress Report for AISC and Oregon Iron Works, Portland State University, Portland, OR.
- Earls, C.J. and Galambos, T.V. (1997), "Design Recommendations for Equal Leg Single Angle Flexural Members," *Journal of Constructional Steel Research*, Vol. 43, Nos. 1-3, pp. 65–85.
- Easterling, W.S., Gibbings, D.R. and Murray, T.M. (1993), "Strength of Shear Studs in Steel Deck on Composite Beams and Joists," *Engineering Journal*, AISC, Vol. 30, No. 2, 2nd Quarter, pp. 44–55.
- Easterling, W.S. and Gonzales, L. (1993), "Shear Lag Effects in Steel Tension Members," *Engineering Journal*, AISC, Vol. 30, No. 3, 3rd Quarter, pp. 77–89.
- ECCS (1984), *Ultimate Limit States Calculations of Sway Frames With Rigid Joints*, Publications No. 33, European Convention for Constructional Steelwork, Rotterdam, the Netherlands.
- ECCS (2001), *Model Code on Fire Engineering*, 1st Ed., European Convention for Constructional Steelwork Technical Committee 3, Brussels, Belgium.
- Elgaaly, M. (1983), "Web Design under Compressive Edge Loads," *Engineering Journal*, AISC, Vol. 20, No. 4, 4th Quarter, pp. 153–171.
- Elgaaly, M. and Salkar, R. (1991), "Web Crippling Under Edge Loading," *Proceedings of AISC National Steel Construction Conference*, Washington, DC.

- Ellifritt, D.S., Wine, G., Sputo, T. and Samuel, S. (1992), "Flexural Strength of WT Sections," *Engineering Journal*, AISC, Vol. 29, No. 2, 2nd Quarter, pp. 67–74.
- Ellingwood, B. and Leyendecker, E.V. (1978), "Approaches for Design Against Progressive Collapse," *Journal of the Structural Division*, ASCE, Vol. 104, No. 3, pp. 413–423.
- Ellingwood, B.E., MacGregor, J.G., Galambos, T.V., and Cornell, C.A. (1982), "Probability-Based Load Criteria: Load Factors and Load Combinations," *Journal of the Structural Division*, ASCE, Vol. 108, No. 5, pp. 978–997.
- Ellingwood, B., and Corotis, R.B. (1991), "Load Combinations for Building Exposed to Fires," *Engineering Journal*, AISC, Vol. 28, No. 1, pp. 37–44.
- El-Zanaty, M.H., Murray, D.W. and Bjorhovde, R. (1980), "Inelastic Behavior Of Multistory Steel Frames," Structural Engineering Report No. 83, University of Alberta, Alberta, BC.
- Felton, L.P. and Dobbs, M.W. (1967), "Optimum Design of Tubes for Bending and Torsion," *Journal of the Structural Division*, ASCE, Vol. 93, No. ST4, pp. 185–200.
- FEMA (1995), *Interim Guidelines: Evaluation, Repair, Modification and Design of Welded Steel Moment Frame Structures*, Bulletin No. 267, Federal Emergency Management Agency, Washington, DC.
- FEMA (1997), "Seismic Performance of Bolted and Riveted Connections" *Background Reports; Metallurgy, Fracture Mechanics, Welding, Moment Connections and Frame Systems Behavior*, Bulletin No. 288, Federal Emergency Management Agency, Washington, DC.
- FEMA (2000), *Steel Moment-Frame Buildings: Design Criteria for New Buildings*, FEMA-350, Prepared by the SAC Joint Venture for the Federal Emergency Management Agency, Washington, DC.
- FHWA (1999), "FHWA Demonstration Project Heat Straightening Repair for Damaged Steel Bridges," FHWA Report No. FHWA-IF-99-004, Federal Highway Administration, Washington, DC.
- Fielding, D.J. and Huang, J.S. (1971), "Shear in Steel Beam-to-Column Connections," *The Welding Journal*, AWS, Vol. 50, No. 7, Research Supplement, pp. 313–326.
- Fielding, D.J. and Chen, W.F. (1973), "Steel Frame Analysis and Connection Shear Deformation," *Journal of the Structural Division*, ASCE, Vol. 99, No. ST1, January, pp. 1–18.
- Fisher, J.M. and West, M.A. (1997), *Erection Bracing of Low-Rise Structural Steel Buildings*, Design Guide 10, AISC, Chicago, IL.
- Fisher, J.M. and Kloiber, L.A. (2006), *Base Plate and Anchor Rod Design*, 2nd Edition, Design Guide 1, AISC, Chicago, IL.
- Fisher, J.W., Frank, K.H., Hirt, M.A. and McNamee, B.M. (1970), "Effect of Weldments on the Fatigue Strength of Beams," Report 102, National Cooperative Highway Research Program, Washington, DC.

- Fisher, J.W., Albrecht, P.A., Yen, B.T., Klingerman, D.J. and McNamee, B.M. (1974), "Fatigue Strength of Steel Beams with Welded Stiffeners and Attachments," Report 147, National Cooperative Highway Research Program, Washington, DC.
- Fisher, J.W., Galambos, T.V., Kulak, G.L. and Ravindra, M.K. (1978), "Load and Resistance Factor Design Criteria for Connectors," *Journal of the Structural Division*, ASCE, Vol. 104, No. ST9, September, pp. 1,427-1,441.
- Frank, K.H. and Fisher, J.W. (1979), "Fatigue Strength of Fillet Welded Cruciform Joints," *Journal of the Structural Division*, ASCE, Vol. 105, No. ST9, September.
- Frank, K.H. and Yura, J.A. (1981), "An Experimental Study of Bolted Shear Connections," FHWA/RD-81/148, Federal Highway Administration, Washington, DC, December.
- Frater, G.S. and Packer, J.A. (1992a), "Weldment Design for RHS Truss Connections. I: Applications," *Journal of Structural Engineering*, ASCE, Vol. 118, No. 10, pp. 2,784-2,803.
- Frater, G.S. and Packer, J.A. (1992b), "Weldment Design for RHS Truss Connections. II: Experimentation," *Journal of Structural Engineering*, ASCE, Vol. 118, No. 10, pp. 2,804-2,820.
- Freeman, F.R. (1930), "The Strength of Arc-Welded Joints," *Proceedings of the Institution of Civil Engineers*, Vol. 231, London, England.
- Freeman, S. (1977), "Racking Tests of High Rise Building Partitions," *Journal of the Structural Division*, ASCE, Vol. 103, No. 8, pp. 1,673-1,685.
- Galambos, T.V. (1968a), *Structural Members and Frames*, Prentice-Hall, Englewood Cliffs, NJ.
- Galambos, T.V. (1968b), "Deformation and Energy Absorption Capacity of Steel Structures in the Inelastic Range," Steel Research for Construction Bulletin No. 8, American Iron and Steel Institute.
- Galambos, T.V. (1978), "Proposed Criteria for Load and Resistance Factor Design of Steel Building Structures," AISI Bulletin No. 27, American Iron and Steel Institute, Washington, DC, January.
- Galambos, T.V., Ellingwood, B., MacGregor, J.G. and Cornell, C.A. (1982), "Probability-Based Load Criteria: Assessment of Current Design Practice," *Journal of the Structural Division*, ASCE, Vol. 108, No. ST5, May, pp. 959-977.
- Galambos, T.V. (1983), "Reliability of Axially Loaded Columns," *Engineering Structures*, Vol. 5, No. 1, pp. 73-78.
- Galambos, T.V. and Ellingwood, B. (1986), "Serviceability Limit States: Deflections," *Journal of the Structural Division*, ASCE, Vol. 112, No. 1, pp. 67-84.
- Galambos, T.V. (1991), "Design of Axially Loaded Compressed Angles," *Proceedings of the Annual Technical Session and Meeting*, Chicago, IL, April 15-17, 1991, Structural Stability Research Council, Bethlehem, PA, pp. 353-367.

- Galambos, T.V. (ed.) (1998), *Guide to Stability Design Criteria for Metal Structures*, 5th Ed., Structural Stability Research Council, John Wiley & Sons, Inc., New York, NY.
- Galambos, T.V. (2001), "Strength of Singly Symmetric I-Shaped Beam-Columns," *Engineering Journal*, AISC, Vol. 38, No. 2, 2nd Quarter, pp. 65-77.
- Galambos, T.V. and Surovek, A.E. (2008), *Structural Stability of Steel—Concepts and Applications for Structural Engineers*, John Wiley & Sons, Inc., New York, NY.
- Geschwindner, L.F. (2002), "A Practical Approach to Frame Analysis, Stability and Leaning Columns," *Engineering Journal*, AISC, Vol. 39, No. 4, 4th Quarter, pp. 167-181.
- Geschwindner, L.F. and Disque, R.O. (2005), "Flexible Moment Connections for Unbraced Frames Subject to Lateral Forces—A Return to Simplicity," *Engineering Journal*, AISC, Vol. 42, No. 2, 2nd Quarter, pp. 99-112.
- Geschwindner, L.F. (2010a), "Notes on the Impact of Hole Reduction on the Flexural Strength of Rolled Beams," *Engineering Journal*, AISC, Vol. 47, No. 1, 1st Quarter, pp. 37-40.
- Geschwindner, L.F. (2010b), "Discussion of Limit State Response of Composite Columns and Beam-Columns Part II: Application of Design Provisions for the 2005 AISC Specification," *Engineering Journal*, AISC, Vol. 47, No. 2, 2nd Quarter, pp. 131-139.
- Geschwindner, L.F. and Gustafson, K. (2010), "Single-Plate Shear Connection Design to Meet Structural Integrity Requirements," *Engineering Journal*, AISC, Vol. 47, No. 4, 3rd Quarter.
- Gewain, R.G. and Troup, E.W.J. (2001), "Restrained Fire Resistance Ratings in Structural Steel Buildings," *Engineering Journal*, Vol. 38, No. 2, pp. 78-89.
- Gibson, G.T. and Wake, B.T. (1942), "An Investigation of Welded Connections for Angle Tension Members," *The Welding Journal*, AWS, January, p. 44.
- Giddings, T.W. and Wardenier, J. (1986), "The Strength and Behaviour of Statically Loaded Welded Connections in Structural Hollow Sections," CIDECT Monograph No. 6, Sections 1-10, British Steel Corporation Tubes Division, Corby, England.
- Gioncu, V. and Petcu, D. (1997), "Available Rotation Capacity of Wide-Flange Beams and Beam-Columns, Part 1. Theoretical Approaches, and Part 2. Experimental and Numerical Tests," *Journal of Constructional Steel Research*, Vol. 43, Nos. 1-3, pp. 161-244.
- Gjelsvik, A. (1981), *The Theory of Thin-Walled Bars*, John Wiley & Sons, Inc., New York, NY.
- Goble, G.G. (1968), "Shear Strength of Thin Flange Composite Specimens," *Engineering Journal*, AISC, Vol. 5, No. 2, 2nd Quarter, pp. 62-65.
- Gomez, I., Kanvinde, A., Kwan, Y.K. and Grondin, G. (2008), "Strength and Ductility of Welded Joints Subjected to Out-of-Plane Bending," Final Report to AISC, University of California, Davis, and University of Alberta, July.
- Goverdhan, A.V. (1983), "A Collection of Experimental Moment Rotation Curves: Evaluation of Predicting Equations for Semi-Rigid Connections," M.S. Thesis, Vanderbilt University, Nashville, TN.

- Graham, J.D., Sherbourne, A.N. and Khabbaz, R.N. (1959), "Welded Interior Beam-to-Column Connections," American Institute of Steel Construction, Chicago, IL.
- Graham, J.D., Sherbourne, A.N., Khabbaz, R.N. and Jensen, C.D. (1960), "Welded Interior Beam-to-Column Connections," Welding Research Council, Bulletin No. 63, pp. 1-28.
- Grant, J.A., Fisher, J.W. and Slutter, R.G. (1977), "Composite Beams with Formed Steel Deck," *Engineering Journal*, AISC, Vol. 14, No. 1, 1st Quarter, pp. 24-43.
- Griffis, L.G. (1992), *Load and Resistance Factor Design of W-Shapes Encased in Concrete*, Design Guide 6, AISC, Chicago, IL.
- Griffis, L.G. (1993), "Serviceability Limit States Under Wind Load," *Engineering Journal*, AISC, Vol. 30, No. 1, 1st Quarter, pp. 1-16.
- Grondin, G., Jin, M. and Josi, G. (2007), "Slip Critical Bolted Connections A Reliability Analysis for the Design at the Ultimate Limit State," Preliminary Report prepared for AISC, University of Alberta, Edmonton, Alberta, CA.
- Hajjar, J.F. (2000), "Concrete-Filled Steel Tube Columns under Earthquake Loads," *Progress in Structural Engineering and Materials*, Vol. 2, No. 1, pp. 72-82.
- Hajjar, J.F., Dexter, R.J., Ojard, S.D., Ye, Y. and Cotton, S.C. (2003), "Continuity Plate Detailing for Steel Moment-Resisting Connections," *Engineering Journal*, AISC, No. 4, 4th Quarter, pp. 81-97.
- Hansen, R.J., Reed, J.W., and Vanmarcke, E.H. (1973), "Human Response to Wind-Induced Motion of Buildings," *Journal of the Structural Division*, ASCE, Vol. 99, No. ST7, pp. 1,589-1,606.
- Hardash, S.G. and Bjorhovde, R. (1985), "New Design Criteria for Gusset Plates in Tension", *Engineering Journal*, AISC, Vol. 22, No. 2, 2nd Quarter, pp. 77-94.
- Heinzerling, J.E. (1987), "Structural Design of Steel Joist Roofs to Resist Ponding Loads," Technical Digest No. 3, Steel Joist Institute, Myrtle Beach, SC.
- Helwig, T.A., Frank, K.H. and Yura, J.A. (1997), "Lateral-Torsional Buckling of Singly-Symmetric I-Beams," *Journal of Structural Engineering*, ASCE, Vol. 123, No. 9, September, pp. 1,172-1,179.
- Higgins, T.R. and Preece, F.R. (1968), "AWS-AISC Fillet Weld Study, Longitudinal and Transverse Shear Tests," Internal Report, Testing Engineers, Inc., Oakland, CA, May 31.
- Horne, M.R. and Morris, L.J. (1982), *Plastic Design of Low-Rise Frames*, MIT Press, Cambridge, MA.
- Horne, M.R. and Grayson, W.R. (1983), "Parametric Finite Element Study of Transverse Stiffeners for Webs in Shear," Instability and Plastic Collapse of Steel Structures, Proceedings of the Michael R. Horne Conference, L.J. Morris (ed.), Granada Publishing, London, pp. 329-341.
- Hsieh, S.H. and Deierlein, G.G. (1991), "Nonlinear Analysis of Three-Dimensional Steel Frames with Semi-Rigid Connections," *Computers and Structures*, Vol. 41, No. 5, pp. 995-1,009.

- ICBO (1997), *Uniform Building Code*, International Conference of Building Officials, Whittier, CA.
- ICC (2009), *International Building Code*, International Code Council, Falls Church, VA.
- IIW (1989), "Design Recommendations for Hollow Section Joints—Predominantly Statically Loaded," 2nd Ed., IIW Document XV-701-89, IIW Annual Assembly, Subcommittee XV-E, International Institute of Welding, Helsinki, Finland.
- Irwin, A.W. (1986), "Motion in Tall Buildings," *Second Century of the Skyscraper*, L.S. Beedle (ed.), Van Nostrand Reinhold Co., New York, NY.
- Islam, M.S., Ellingwood, B. and Corotis, R.B. (1990), "Dynamic Response of Tall Buildings to Stochastic Wind Load," *Journal of Structural Engineering*, ASCE, Vol. 116, No. 11, November, pp. 2,982–3,002.
- ISO (1977), "Bases for the Design of Structures—Deformations of Buildings at the Serviceability Limit States," ISO 4356, International Standards Organization, Geneva, Switzerland.
- Iwankiw, N. (1984), "Note on Beam-Column Moment Amplification Factor," *Engineering Journal*, AISC, Vol. 21, No. 1, 1st Quarter, pp. 21-23.
- Jacobs, W.J. and Goverdhan, A.V. (2010), "Review and Comparison of Encased Composite Steel-Concrete Column Detailing Requirements," *Composite Construction in Steel and Concrete VI*, R. Leon et al. (eds.), ASCE, Reston, VA.
- Jayas, B.S. and Hosain, M.U. (1988a), "Composite Beams with Perpendicular Ribbed Metal Deck," *Composite Construction in Steel and Concrete II*, C.D. Buckner and I.M. Viest, (eds.), American Society of Civil Engineers, New York, NY, pp. 511–526.
- Jayas, B.S. and Hosain, M.U. (1988b), "Behaviour of Headed Studs in Composite Beams: Push-Out Tests," *Canadian Journal of Civil Engineering*, Vol. 15, pp. 240–253.
- JCRC (1971), *Handbook of Structural Stability*, Japanese Column Research Council, English translation, pp. 3–22.
- Johnson, D.L. (1985), "An Investigation into the Interaction of Flanges and Webs in Wide-Flange Shapes," *Proceedings of the Annual Technical Session and Meeting*, Cleveland, OH, April 16-17, 1985, Structural Stability Research Council, Bethlehem, PA, pp. 397–405.
- Johnson, D.L. (1996), "Final Report on Tee Stub Tests," Butler Corporation Research Report, Grandview, MO, May.
- Johnson, R.P. and Yuan, H. (1998), "Existing Rules and New Tests for Stud Shear Connectors in Troughs of Profiled Sheeting," *Proceedings of the Institution of Civil Engineers: Structures and Buildings*, Vol. 128, No. 3, pp. 244–251.
- Johnston, B.G. (1939), "Pin-Connected Plate Links," *Transactions of the ASCE*, Vol. 104, pp. 314–339.
- Johnston, B.G. and Green, L.F. (1940), "Flexible Welded Angle Connections," *The Welding Journal*, AWS, October.

- Johnston, B.G. and Deits, G.R. (1942), "Tests of Miscellaneous Welded Building Connections," *The Welding Journal*, AWS, November, p. 5.
- Johnston, B.G. (ed.) (1976), *Guide to Stability Design for Metal Structures*, 3rd Ed., Structural Stability Research Council, John Wiley & Sons, Inc., New York, NY.
- Kaczinski, M.R., Schneider, C.R., Dexter, R.J. and Lu, L.-W. (1994), "Local Web Crippling of Unstiffened Multi-Cell Box Sections," *Proceedings of the ASCE Structures Congress '94*, Atlanta, GA, Vol. 1, American Society of Civil Engineers, New York, NY, pp. 343-348.
- Kaehler, R.C., White, D.W. and Kim, Y.D. (2010), *Frame Design Using Web-Tapered Members*, Design Guide 25, Metal Building Manufacturers Association and AISC, Chicago, IL.
- Kanchanalai, T. (1977), *The Design and Behavior of Beam-Columns in Unbraced Steel Frames*, AISI Project No. 189, Report No. 2, Civil Engineering/Structures Research Lab., University of Texas, Austin, TX.
- Kanchanalai, T. and Lu, L.-W. (1979), "Analysis and Design of Framed Columns under Minor Axis Bending," *Engineering Journal*, AISC, Vol. 16, No. 2, 2nd Quarter, pp. 29-41.
- Kato, B. (1990), "Deformation Capacity of Steel Structures," *Journal of Constructional Steel Research*, Vol. 17, No. 1-2, pp. 33-94.
- Kaufmann, E.J., Metrovich, B., Pense, A.W. and Fisher, J.W. (2001), "Effect of Manufacturing Process on k-Area Properties and Service Performance," *Proceedings of the North American Steel Construction Conference*, Fort Lauderdale, FL, May 9-12, 2001, American Institute of Steel Construction, Chicago, IL, pp. 17.1-17.24.
- Kavanagh, T.C. (1962), "Effective Length of Framed Columns," *Transactions of the American Society of Civil Engineers*, Vol. 127, pp. 81-101.
- Keating, P.B. and Fisher, J.W. (1986), "Evaluation of Fatigue Tests and Design Criteria on Welded Details," NCHRP Report No. 286, Transportation Research Board, Washington DC, September.
- Kemp, A.R. (1996), "Inelastic Local and Lateral Buckling in Design Codes," *Journal of Structural Engineering*, ASCE, Vol. 122, No. 4, pp. 374-382.
- Kim, H.J. and Yura, J.A. (1996), "The Effect of End Distance on the Bearing Strength of Bolted Connections," PMFSEL Report No. 96-1, University of Texas, Austin, TX.
- Kim, Y.D., Jung, S.-K. and White, D.W. (2007), "Transverse Stiffener Requirements in Straight and Horizontally Curved Steel I-Girders," *Journal of Bridge Engineering*, ASCE, Vol. 12, No. 2, pp. 174-183.
- Kirby, B.R. and Preston, R.R. (1988), "High Temperature Properties of Hot-Rolled Structural Steels for Use in Fire Engineering Design Studies," *Fire Safety Journal*, Vol. 13, pp. 27-37.
- Kirby, P.A. and Nethercot, D.A. (1979), *Design for Structural Stability*, John Wiley & Sons, Inc., New York, NY.

- Kishi, N. and Chen, W.F. (1986), "Data Base of Steel Beam-to-Column Connections," Vol. 1 and 2, Structural Engineering Report No. CE-STR-86-26, School of Civil Engineering, Purdue University, West Lafayette, IN.
- Kitipornchai, S. and Trahair, N.S. (1980), "Buckling Properties of Monosymmetric I-Beams," *Journal of the Structural Division*, ASCE, Vol. 106, No. ST5, May, pp. 941-957.
- Kitipornchai, S. and Traves, W.H. (1989), "Welded-Tee End Connections for Circular Hollow Tubes," *Journal of Structural Engineering*, ASCE, Vol. 115, No.12, pp. 3,155-3,170.
- Klöppl, K. and Seeger, T. (1964), "Dauerversuche Mit Einschnittigen HV-Verbindungen Aus ST37," *Der Stahlbau*, Vol. 33, No. 8, August, pp. 225-245 and Vol. 33, No. 11, November, pp. 335-346.
- Kosteski, N. and Packer, J.A. (2003), "Longitudinal Plate and Through Plate-to-HSS Welded Connections," *Journal of Structural Engineering*, ASCE, Vol. 129, No. 4, pp. 478-486.
- Kuchenbecker, G.H., White, D.W. and Surovek-Maleck, A.E. (2004), "Simplified Design of Building Frames Using First-Order Analysis and $K = 1$," *Proceedings of the Annual Technical Session and Meeting*, Long Beach, CA, March 24-27, 2004, Structural Stability Research Council, Rolla, MO, pp. 119-138.
- Kulak, G.L., Fisher, J.W. and Struik, J.H.A. (1987), *Guide to Design Criteria for Bolted and Riveted Joints*, 2nd Ed., John Wiley & Sons, Inc., New York, NY.
- Kulak, G.L. and Grondin, G.Y. (2001), "AISC LRFD Rules for Block Shear—A Review," *Engineering Journal*, AISC, Vol. 38, No. 4, 4th Quarter, pp. 199-203.
- Kulak, G.L. and Grondin, G.Y. (2002), "Closure: AISC LRFD Rules for Block Shear—A Review," *Engineering Journal*, AISC, Vol. 39, No. 4, 4th Quarter, p. 241.
- Kulak, G.L. and Grondin, G.Y. (2003), "Strength of Joints that Combine Bolts and Welds," *Engineering Journal*, AISC, Vol. 40, No. 2, 2nd Quarter, pp. 89-98.
- Kulak, G.L. (2002), *High Strength Bolts: A Primer for Structural Engineers*, Design Guide 17, AISC, Chicago, IL.
- Kurobane, Y., Packer, J.A., Wardenier, J. and Yeomans, N.F. (2004), "Design Guide for Structural Hollow Section Column Connections," CIDECT Design Guide No. 9, CIDECT (ed.) and Verlag TÜV Rheinland, Köln, Germany.
- Lawson, R.M. (1992), "Shear Connection in Composite Beams," *Composite Construction in Steel and Concrete II*, W.S. Easterling and W.M.K. Roddis, (eds.), American Society of Civil Engineers, New York, NY.
- Lee, D., Cotton, S., Dexter, R.J., Hajjar, J.F., Ye, Y. and Ojard, S.D. (2002a), "Column Stiffener Detailing and Panel Zone Behavior of Steel Moment Frame Connections," Report No. ST-01-3.2, Department of Civil Engineering, University of Minnesota, Minneapolis, MN.

- Lee, S.C., Yoo, C.H. and Yoon, D.Y. (2002b), "Behavior of Intermediate Transverse Stiffeners Attached on Web Panels," *Journal of Structural Engineering*, ASCE, Vol. 128, No. 3, pp. 337-345.
- Leigh, J.M. and Lay, M.G. (1978), "Laterally Unsupported Angles with Equal and Unequal Legs," Report MRL 22/2, July, Melbourne Research Laboratories, Clayton, Victoria, Australia.
- Leigh, J.M. and Lay, M.G. (1984), "The Design of Laterally Unsupported Angles," *Steel Design Current Practice*, Section 2, Bending Members, American Institute of Steel Construction, Chicago, IL, January.
- LeMessurier, W.J. (1976), "A Practical Method of Second Order Analysis, Part 1—Pin-Jointed Frames," *Engineering Journal*, AISC, Vol. 13, No. 4, 4th Quarter, pp. 89-96.
- LeMessurier, W.J. (1977), "A Practical Method of Second Order Analysis, Part 2—Rigid Frames," *Engineering Journal*, AISC, Vol. 14, No. 2, 2nd Quarter, pp. 49-67.
- LeMessurier, W.J. (1995), "Simplified K Factors for Stiffness Controlled Designs," *Restructuring: America and Beyond, Proceedings of ASCE Structures Congress XIII*, Boston, MA, April 2-5, 1995, American Society of Civil Engineers, New York, NY, pp. 1,797-1,812.
- Leon, R.T. (1990), "Serviceability of Composite Floor," *Proceedings of the 1990 National Steel Construction Conference*, AISC, pp. 18:1-18:23.
- Leon, R.T. and Alsamsam, I. (1993), Performance and Serviceability of Composite Floors, Structural Engineering in Natural Hazards Mitigation, *Proceedings of the ASCE Structures Congress*, ASCE, pp. 1,479-1,484.
- Leon, R.T. (1994), "Composite Semi-Rigid Construction," *Engineering Journal*, AISC, Vol. 31, No. 2, 2nd Quarter, pp. 57-67.
- Leon, R.T., Hoffman, J. and Staeger, T. (1996), *Design of Partially-Restrained Composite Connections*, Design Guide 8, AISC, Chicago, IL.
- Leon, R.T. and Easterling, W.S. (eds.) (2002), *Connections in Steel Structures IV Behavior, Strength and Design*, American Institute of Steel Construction, Chicago, IL.
- Leon, R.T., Kim, D.K. and Hajjar, J.F. (2007), "Limit State Response of Composite Columns and Beam-Columns Part 1: Formulation of Design Provisions for the 2005 AISC Specification," *Engineering Journal*, AISC, Vol. 44, No. 4, 4th Quarter, pp. 341-358.
- Leon, R.T. and Hajjar, J.F. (2008), "Limit State Response of Composite Columns and Beam-Columns Part 2: Application of Design Provisions for the 2005 AISC Specification," *Engineering Journal*, AISC, Vol. 45, No. 1, 1st Quarter, pp. 21-46.
- Lesik, D.F. and Kennedy, D.J.L. (1990), "Ultimate Strength of Fillet Welded Connections Loaded in Plane," *Canadian Journal of Civil Engineering*, Vol. 17, No. 1, pp. 55-67.
- Lewis, B.E. and Zwerneman, F.J. (1996), "Edge Distance, Spacing, and Bearing in Bolted Connections," Research Report, Department of Civil and Environmental Engineering, Oklahoma State University, Stillwater, OK, July.

- Liew, J.Y., White, D.W. and Chen, W.F. (1993), "Second-Order Refined Plastic-Hinge Analysis for Frame Design, Parts I and II," *Journal of Structural Engineering*, ASCE, Vol. 119, No. 11, pp. 3,196-3,237.
- Lorenz, R.F., Kato, B. and Chen, W.F. (eds.) (1993), *Semi-Rigid Connections in Steel Frames*, Council for Tall Buildings and Urban Habitat, Bethlehem, PA.
- Lu, Y.O. and Kennedy, D.J.L. (1994), "The Flexural Behaviour of Concrete-Filled Hollow Structural Sections," *Canadian Journal of Civil Engineering*, Vol. 21, No. 1, pp. 111-130.
- Lui, Z. and Goel, S.C. (1987), "Investigation of Concrete-Filled Steel Tubes Under Cyclic Bending and Buckling," UMCE Report 87-3, Department of Civil and Environmental Engineering, University of Michigan, Ann Arbor, MI.
- Lutz, L.A. and Fisher, J.M. (1985), "A Unified Approach for Stability Bracing Requirements," *Engineering Journal*, AISC, Vol. 22, No. 4, 4th Quarter, pp. 163-167.
- Lutz, L.A. (1992), "Critical Slenderness of Compression Members with Effective Lengths about Non-Principal Axes," *Proceedings of the Annual Technical Session and Meeting*, April 6-7, 1992, Pittsburgh, PA, Structural Stability Research Council, Bethlehem, PA.
- Lyse, I. and Schreiner, N.G. (1935), "An Investigation of Welded Seat Angle Connections," *The Welding Journal*, AWS, February, p. 1.
- Lyse, I. and Gibson, G.J. (1937), "Effect of Welded Top Angles on Beam-Column Connections," *The Welding Journal*, AWS, October.
- Madugula, M.K.S. and Kennedy, J.B. (1985), *Single and Compound Angle Members*, Elsevier Applied Science, New York, NY.
- Marino, F.J. (1966), "Ponding of Two-Way Roof Systems," *Engineering Journal*, AISC, Vol. 3, No. 3, 3rd Quarter, pp. 93-100.
- Marshall, P.W. (1992), *Design of Welded Tubular Connections: Basis and Use of AWS Code Provisions*, Elsevier, Amsterdam, the Netherlands.
- Martinez-Garcia, J.M. and Ziemian, R.D. (2006), "Benchmark Studies to Compare Frame Stability Provisions," *Proceedings—Annual Technical Session and Meeting*, Structural Stability Research Council, San Antonio, TX, pp. 425-442.
- McGuire, W. (1992), "Computer-Aided Analysis," *Constructional Steel Design: An International Guide*, P.J. Dowling, J.E. Harding and R. Bjorhovde (eds.), Elsevier Applied Science, New York, NY, pp. 915-932.
- McGuire, W., Gallagher, R.H. and Ziemian, R.D. (2000), *Matrix Structural Analysis*, 2nd Ed., John Wiley & Sons, Inc., New York, NY.
- Mottram, J.T. and Johnson, R.P. (1990), "Push Tests on Studs Welded Through Profiled Steel Sheeting," *The Structural Engineer*, Vol. 68, No. 10, pp. 187-193.
- Munse, W.H. and Chesson, Jr., E., (1963), "Riveted and Bolted Joints: Net Section Design," *Journal of the Structural Division*, ASCE, Vol. 89, No. ST1, February, pp. 49-106.

- Murray, T.M., Kline, D.P. and Rojani, K.B. (1992), “Use of Snug-Tightened Bolts in End-Plate Connections,” *Connections in Steel Structures II*, R. Bjorhovde, A. Colson, G. Haaijer and J.W.B. Stark, (eds.), AISC, Chicago, IL.
- Murray, T.M., Allen, D.E. and Ungar, E.E. (1997), *Floor Vibrations Due to Human Activity*, Design Guide 11, AISC, Chicago, IL.
- Murray, T.M. and Sumner, E.A. (2004), *End-Plate Moment Connections—Wind and Seismic Applications*, Design Guide 4, 2nd Ed., AISC, Chicago, IL.
- Nethercot, D.A. (1985), “Steel Beam to Column Connections—A Review of Test Data and Their Applicability to the Evaluation of the Joint Behaviour of the Performance of Steel Frames,” CIRIA, London, England.
- NFPA (2002a), *Standard for the Inspection, Testing, and Maintenance of Water-Based Fire Protection Systems*, NFPA 25, National Fire Protection Association, Quincy, MA.
- NFPA (2002b), *Standard on Smoke and Heat Venting*, NFPA 204, National Fire Protection Association, Quincy, MA.
- Nowak, A.S. and Collins, K. R. (2000), *Reliability of Structures*, McGraw-Hill, New York, NY.
- NRC (1974), “Expansion Joints in Buildings,” Technical Report No. 65, Standing Committee on Structural Engineering of the Federal Construction Council, Building Research Advisory Board, Division of Engineering, National Research Council, National Academy of Sciences, Washington, DC.
- NRCC (1990), *National Building Code of Canada*, National Research Council of Canada, Ottawa, Ontario, Canada.
- Oehlers, D.J. and Bradford, M.A. (1995), *Composite Steel and Concrete Members*, Elsevier Science, Inc., Tarrytown, NY.
- Olgaard, J.G., Slutter, R.G. and Fisher, J.W. (1971), “Shear Strength of Stud Shear Connections in Lightweight and Normal Weight Concrete,” *Engineering Journal*, AISC, Vol. 8, No. 2, 2nd Quarter, pp. 55–64.
- OSHA (2001), *Safety and Health Regulations for Construction*, Standards—29 CFR 1926 Subpart R—Steel Erection, Occupational Safety and Health Administration, Washington, DC.
- Packer, J.A., Birkemoe, P.C., and Tucker, W.J. (1984), “Canadian Implementation of CIDECT Monograph No. 6,” CIDECT Report No. 5AJ-84/9-E, University of Toronto, Toronto, Canada.
- Packer, J.A. and Cassidy, C.E. (1995), “Effective Weld Length for HSS T, Y and X Connections,” *Journal of Structural Engineering*, ASCE, Vol. 121, No. 10, pp. 1,402–1,408.
- Packer, J.A. and Henderson, J.E. (1997), *Hollow Structural Section Connections and Trusses—A Design Guide*, 2nd Ed., Canadian Institute of Steel Construction, Toronto, Canada.
- Packer, J.A. (2004), “Reliability of Welded Tubular K-Connection Resistance Expressions,” International Institute of Welding (IIW) Document XV-E-04-291, University of Toronto, Toronto, Canada.

- Packer, J.A. and Wardenier, J. (2010), “Design Guide for Rectangular Hollow Section (RHS) Joints under Predominantly Static Loading,” Design Guide No. 3, CIDECT, 2nd Ed., LSS Verlag, Köln, Germany.
- Pallarés, L. and Hajjar, J.F. (2010a), “Headed Steel Stud Anchors in Composite Structures: Part II. Tension and Interaction,” *Journal of Constructional Steel Research*, Vol. 66, No. 2, February, pp. 213–228.
- Pallarés, L. and Hajjar, J.F. (2010b), “Headed Steel Stud Anchors in Composite Structures: Part I. Shear,” *Journal of Constructional Steel Research*, Vol. 66, No. 2, February, pp. 198–212.
- Pate-Cornell, E. (1994), “Quantitative Safety Goals for Risk Management of Industrial Facilities,” *Structural Safety*, Vol. 13, No. 3, pp. 145–157.
- Popov, E.P. and Stephen, R.M. (1977), “Capacity of Columns with Splice Imperfections,” *Engineering Journal*, AISC, Vol. 14, No. 1, 1st Quarter, pp. 16–23.
- Popov, E.P. (1980), “An Update on Eccentric Seismic Bracing,” *Engineering Journal*, AISC, Vol. 17, No. 3, 3rd Quarter, pp. 70–71.
- Preece, F.R. (1968), “AWS-AISC Fillet Weld Study—Longitudinal and Transverse Shear Tests,” Testing Engineers, Inc., Los Angeles, CA, May.
- Prion, H.G.L. and Boehme, J. (1994), “Beam-column behaviour of steel tubes filled with high strength concrete,” *Canadian Journal of Civil Engineering*, Vol. 21, No. 2, pp. 207–218.
- Prochnow, S.D., Ye, Y., Dexter, R.J., Hajjar, J.F. and Cotton, S.C. (2000), “Local Flange Bending and Local Web Yielding Limit States in Steel Moment Resisting Connections,” *Connections in Steel Structures IV Behavior, Strength and Design*, R.T. Leon and W.S. Easterling (eds.), AISC, Chicago, IL, pp. 318–328.
- Rahal, K.N. and Harding, J.E. (1990a), “Transversely Stiffened Girder Webs Subjected to Shear Loading—Part 1: Behaviour,” *Proceedings of the Institution of Civil Engineers*, Part 2, 1989, March, pp. 47–65.
- Rahal, K.N. and Harding, J.E. (1990b), “Transversely Stiffened Girder Webs Subjected to Shear Loading—Part 2: Stiffener Design,” *Proceedings of the Institution of Civil Engineers*, Part 2, 1989, March, pp. 67–87.
- Rahal, K.N. and Harding, J.E. (1991), “Transversely Stiffened Girder Webs Subjected to Combined In-Plane Loading,” *Proceedings of the Institution of Civil Engineers*, Part 2, 1991, June, pp. 237–258.
- Ravindra, M.K. and Galambos, T.V. (1978), “Load and Resistance Factor Design for Steel,” *Journal of the Structural Division*, ASCE, Vol. 104, No. ST9, September, pp. 1,337–1,353.
- RCSC (2009), *Specification for Structural Joints Using High Strength Bolts*, Research Council on Structural Connections, American Institute of Steel Construction, Chicago, IL.
- Ricker, D.T. (1989), “Cambering Steel Beams,” *Engineering Journal*, AISC, Vol. 26, No. 4, 4th Quarter, pp. 136–142.

- Ricles, J.M. and Yura, J.A. (1983), "Strength of Double-Row Bolted Web Connections," *Journal of the Structural Division*, ASCE, Vol. 109, No. ST 1, January, pp. 126-142.
- Roberts, T.M. (1981), "Slender Plate Girders Subjected to Edge Loading," *Proceedings of the Institution of Civil Engineers*, Part 2, No. 71, September.
- Robinson, H. (1967), "Tests of Composite Beams with Cellular Deck," *Journal of the Structural Division*, ASCE, Vol. 93, No. ST4, pp. 139-163.
- Roddenberry, M.R., Easterling, W.S. and Murray, T.M. (2002a) "Behavior and Strength of Welded Stud Shear Connectors," Report No. CE/VPI-02/04, Virginia Polytechnic Institute and State University, Blacksburg, VA.
- Roddenberry, M.R., Lyons, J.C., Easterling, W.S. and Murray, T.M. (2002b), "Performance and Strength of Welded Shear Studs," *Composite Construction in Steel and Concrete IV*, J.F. Hajjar, M. Hosain, W.S. Easterling and B.M. Shahrooz (eds.), American Society of Civil Engineers, Reston, VA, pp. 458-469.
- Roeder, C.W., Cameron, B. and Brown, C.B. (1999), "Composite Action in Concrete Filled Tubes," *Journal of Structural Engineering*, ASCE, Vol. 125, No. 5, May, pp. 477-484.
- Roik, K. and Bergmann, R. (1992), "Composite Column," *Constructional Steel Design: An International Guide*, P.J. Dowling, J.E. Harding and R. Bjorhovde, (eds.), Elsevier Applied Science, London, United Kingdom.
- Rolloos, A. (1969), "The Effective Weld Length of Beam to Column Connections without Stiffening Plates," Stevin Report 6-69-7-HL, Delft University of Technology, Delft, the Netherlands.
- Ruddy, J. (1986), "Ponding of Concrete Deck Floors," *Engineering Journal*, AISC, Vol. 23, No. 3, 3rd Quarter, pp. 107-115.
- Ruddy, J.L., Marlo, J.P., Ioannides, S.A. and Alfawakhiri, F. (2003), *Fire Resistance of Structural Steel Framing*, Design Guide 19, AISC, Chicago, IL.
- Salmon, C.G. and Johnson, J.E. (1996), *Steel Structures, Design and Behavior*, 4th Ed., HarperCollins College Publishers, New York, NY.
- Salmon, C.G., Johnson, J.E. and Malhas, F.A. (2008), *Steel Structures: Design and Behavior*, Prentice-Hall, Upper Saddle River, NJ.
- Salvadori, M. (1956), "Lateral Buckling of Eccentrically Loaded I-Columns," *Transactions of the ASCE*, Vol. 122, No. 1.
- Sato, A. and Uang, C.-M. (2007), "Modified Slenderness Ratio for Built-up Members," *Engineering Journal*, AISC, pp. 269-280.
- Schilling, C.G. (1965), Buckling Strength of Circular Tubes, *Journal of the Structural Division*, ASCE, Vol. 91, No. ST5, pp. 325-348.
- Schuster, J.W. (1997), *Structural Steel Fabrication Practices*, McGraw-Hill, New York, NY.
- SDI (2001), *Standard Practice Details*, Steel Deck Institute, Fox River Grove, IL.
- SDI (2004), *Diaphragm Design Manual*, Steel Deck Institute, Fox River Grove, IL.

- Seaburg, P.A. and Carter, C.J. (1997), *Torsional Analysis of Structural Steel Members*, Design Guide 9, AISC, Chicago, IL.
- SFPE (2002), *Handbook of Fire Protection Engineering*, 3rd Ed., P.J. DiNunno (ed.), National Fire Protection Association, Quincy, MA.
- SFSA (1995), *Steel Castings Handbook*, Steel Founders Society of America, Crystal Lake, IL.
- Shanmugam, N.E. and Lakshmi, B. (2001), "State of the Art Report on Steel-Concrete Composite Columns," *Journal of Constructional Steel Research*, Vol. 57, No. 10, October, pp. 1,041-1,080.
- Sherbourne, A.N. and Jensen, C.D. (1957), "Direct Welded Beam Column Connections," Report. No. 233.12, Fritz Engineering Laboratory, Lehigh University, Bethlehem, PA.
- Sherman, D.R. (1976), "Tentative Criteria for Structural Applications of Steel Tubing and Pipe," American Iron and Steel Institute, Washington, DC, August.
- Sherman, D.R. and Tanavde, A.S. (1984), "Comparative Study of Flexural Capacity of Pipes," Internal Report, Department of Civil Engineering, University of Wisconsin-Milwaukee, WI, March.
- Sherman, D.R. and Ales, J.M. (1991), "The Design of Shear Tabs with Tubular Columns," *Proceedings of the National Steel Construction Conference*, Washington, DC, American Institute of Steel Construction, Chicago, IL, pp. 1.2-1.22.
- Sherman, D.R. (1992), "Tubular Members," *Constructional Steel Design—An International Guide*, P.J. Dowling, J.H. Harding and R. Bjorhovde (eds.), Elsevier Applied Science, London, England, pp. 91-104.
- Sherman, D.R. (1995a), "Stability Related Deterioration of Structures," *Proceedings of the Annual Technical Session and Meeting*, Kansas City, MO, March 27-28, 1995, Structural Stability Research Council, Bethlehem, PA.
- Sherman, D.R. (1995b), "Simple Framing Connections to HSS Columns," *Proceedings of the National Steel Construction Conference*, San Antonio, Texas, American Institute of Steel Construction, Chicago, IL, pp. 30.1-30.16.
- Sherman, D.R. (1996), "Designing with Structural Tubing," *Engineering Journal*, AISC, Vol. 33, No. 3, 3rd Quarter, pp. 101-109.
- Slutter, R.G. and Driscoll, G.C. (1965), "Flexural Strength of Steel-Concrete Composite Beams," *Journal of the Structural Division*, ASCE, Vol. 91, No. ST2, April, pp. 71-99.
- Sourochnikoff, B. (1950), "Wind Stresses in Semi-Rigid Connections of Steel Framework," *Transactions of the ASCE*, Vol. 115, pp. 382-402.
- Stang, A.H. and Jaffe, B.S. (1948), *Perforated Cover Plates for Steel Columns*, Research Paper RP1861, National Bureau of Standards, Washington, DC.
- Stanway, G.S., Chapman, J.C. and Dowling, P.J. (1993), "Behaviour of a Web Plate in Shear with an Intermediate Stiffener," *Proceedings of the Institution of Civil Engineers, Structures and Buildings*, Vol. 99, August, pp. 327-344.

- Stanway, G.S., Chapman, J.C. and Dowling, P.J. (1996), “A Design Model for Intermediate Web Stiffeners,” *Proceedings of the Institution of Civil Engineers, Structures and Buildings*, Vol. 116, February, pp. 54–68.
- Summers, P.A. and Yura, J.A. (1982), “The Behavior of Beams Subjected to Concentrated Loads,” Report No. 82-5, Phil M. Ferguson Structural Engineering Laboratory, University of Texas, Austin, TX, August.
- Surovek-Maleck, A.E. and White, D.W. (2003). “Direct Analysis Approach for the Assessment of Frame Stability: Verification Studies,” *Proceedings—Annual Technical Session and Meeting*, Structural Stability Research Council, Baltimore, MD, pp. 423–441.
- Surovek-Maleck, A., White, D.W. and Leon, R.T. (2004), “Direct Analysis and Design of Partially-Restrained Steel Framing Systems,” *Journal of Structural Engineering*, ASCE, Vol. 131, No. 9, pp. 1376–1389.
- Takagi, J. and Deierlein, G.G. (2007), “Strength Design Criteria for Steel Members at Elevated Temperatures,” *Journal of Constructional Steel Research*, Vol. 63, pp. 1036–1050.
- Taylor, A.C. and Ojalvo, M. (1966), “Torsional Restraint of Lateral Buckling,” *Journal of the Structural Division*, ASCE, Vol. 92, No. ST2, pp. 115–129.
- Thoft-Christensen, P. and Murotsu, Y. (1986) *Application of Structural System Reliability Theory*, Springer Verlag, Berlin.
- Tide, R.H.R. (1985), “Reasonable Column Design Equations,” *Proceedings of the Annual Technical Session and Meeting*, Cleveland, OH, April 16-17, 1985, Structural Stability Research Council, Bethlehem, PA.
- Tide, R.H.R. (1999), “Evaluation of Steel Properties and Cracking in the ‘k’-area of W Shapes,” *Engineering Structures*, Vol. 22, pp. 128-124.
- Tide, R.H.R. (2001), “A Technical Note: Derivation of the LRFD Column Design Equations,” *Engineering Journal*, AISC, Vol. 38, No. 3, 3rd Quarter, pp. 137–139.
- Tide, R.H.R. (2010), “Bolt Shear Design Considerations,” *Engineering Journal*, AISC, Vol. 47, No. 1, 1st Quarter, pp. 47–64.
- Timoshenko, S.P. (1956), *Strength of Materials*, Vol. II, 3rd Ed., D. Van Nostrand, New York, NY.
- Timoshenko, S.P. and Gere, J.M. (1961), *Theory of Elastic Stability*, McGraw-Hill Book Company, New York, NY.
- Troup, E.W. (1999), “Effective Contract and Shop Drawings for Structural Steel,” *Proceedings of the AISC National Steel Construction Conference*, Toronto, Ontario, May 19-21, 1999, American Institute of Steel Construction, Chicago, IL pp. 37-1–37-15.
- Van der Sanden, P.G.F.J. (1996), “The Behaviour of a Headed Stud Connection in a ‘New’ Push Test including a Ribbed Slab. Tests: Main Report,” BKO Report No. 95-15, Eindhoven University of Technology, Eindhoven, the Netherlands, March.

- Varma, A.H., Ricles, J.M., Sause, R. and Lu, L.-W. (2002), "Experimental Behavior of High Strength Square Concrete Filled Steel Tube (CFT) Columns," *Journal of Structural Engineering*, ASCE, Vol. 128, No. 3, pp. 309-318.
- Varma, A.H. and Zhang, K. (2009), "Slenderness Limits for Noncompact/Slender Filled Members," Bowen Laboratory Report No. 2009-01, School of Civil Engineering, Purdue University, West Lafayette, IN, August.
- Vickery, B.J., Isyumov, N. and Davenport, A.G. (1983), "The Role of Damping, Mass and Stiffness in the Reduction of Wind Effects on Structures," *Journal of Wind Engineering and Industrial Aerodynamics*, Vol. 11, Nos. 1-3, pp. 285-294.
- Viest, I.M., Siess, C.P., Appleton, J.H. and Newmark, N. (1952), "Full-Scale Tests of Channel Shear Connectors and Composite T-Beams," Bulletin Series No. 405, Vol. 50, No. 29, University of Illinois Engineering Experiment Station, University of Illinois, Urbana, IL.
- Viest, I.M., Colaco, J.P., Furlong, R.W., Griffis, L.G., Leon, R.T. and Wyllie, L.A., Jr. (1997), *Composite Construction: Design for Buildings*, McGraw-Hill, New York, NY.
- von Kármán, T., Sechler, E.E. and Donnell, L.H. (1932), "The Strength of Thin Plates in Compression," *Transactions of the ASME*, Vol. 54.
- Wardenier, J., Davies, G. and Stolle, P. (1981), "The Effective Width of Branch Plate to RHS Chord Connections in Cross Joints," Stevin Report 6-81-6, Delft University of Technology, Delft, the Netherlands.
- Wardenier, J., Kurobane, Y., Packer, J.A., Dutta, D. and Yeomans, N. (1991), *Design Guide for Circular Hollow Section (CHS) Joints under Predominantly Static Loading*, CIDECT Design Guide No. 1, CIDECT (ed.) and Verlag TÜV Rheinland, Köln, Germany.
- West, M.A., Fisher, J.M. and Griffis, L.G. (2003), *Serviceability Design Considerations for Steel Buildings*, Design Guide 3, 2nd Ed., AISC, Chicago, IL.
- Wheeler, A. and Bridge, R. (2006), "The Behaviour of Circular Concrete-Filled Thin-Walled Steel Tubes in Flexure," *Proceedings of the 5th International Conference on Composite Construction in Steel and Concrete V*, R.T. Leon and J. Lange (eds.), ASCE, Reston, Virginia, pp. 413-423.
- White, D.W. and Chen, W.F. (ed.) (1993), *Plastic Hinge Based Methods for Advanced Analysis and Design of Steel Frames: An Assessment of State-of-the-Art*, Structural Stability Research Council, Bethlehem, PA.
- White, D.W. and Hajjar, J.F. (1997a), "Design of Steel Frames without Consideration of Effective Length," *Engineering Structures*, Vol. 19, No. 10, pp. 797-810.
- White, D.W. and Hajjar, J.F. (1997b), "Buckling Models and Stability Design of Steel Frames: a Unified Approach," *Journal of Constructional Steel Research*, Vol. 42, No. 3, pp. 171-207.
- White, D.W. (2003), "Improved Flexural Design Provisions for I-Shaped Members and Channels," Structural Engineering, Mechanics and Materials Report No. 23, School of Civil and Environmental Engineering, Georgia Institute of Technology, Atlanta, GA.

- White, D.W. and Jung, S.K. (2003), "Simplified Lateral-Torsional Buckling Equations for Singly-Symmetric I-Section Members," Structural Engineering, Mechanics and Materials Report No. 24b, School of Civil and Environmental Engineering, Georgia Institute of Technology, Atlanta, GA.
- White, D.W. (2004), "Unified Flexural Resistance Equations for Stability Design of Steel I-Section Members Overview," Structural Engineering, Mechanics and Materials Report No. 24a, School of Civil and Environmental Engineering, Georgia Institute of Technology, Atlanta, GA.
- White, D.W. and Barker, M. (2008), "Shear Resistance of Transversely-Stiffened Steel I-Girders," *Journal of Structural Engineering*, ASCE, Vol. 134, No. 9, pp. 1,425-1,436.
- White, D.W. and Goverdhan, A.V. (2008), "Design of PR Frames Using the AISC Direct Analysis Method," in *Connections in Steel Structures VI*, R. Bjorhovde, F.S.K. Bijlaard and L.F. Geschwindner (eds.), AISC, Chicago, IL, pp. 255-264.
- Wilkinson, T. and Hancock, G.J. (1998), "Tests to Examine Compact Web Slenderness of Cold-Formed RHS," *Journal of Structural Engineering*, ASCE, Vol. 124, No. 10, October, pp. 1,166-1,174.
- Wilkinson, T. and Hancock, G.J. (2002), "Predicting the Rotation Capacity of Cold-Formed RHS Beams Using Finite Element Analysis," *Journal of Constructional Steel Research*, Vol. 58, No. 11, November, pp. 1,455-1,471.
- Wilson, W.M. (1934), "The Bearing Value of Rollers," Bulletin No. 263, University of Illinois Engineering Experiment Station, Urbana, IL.
- Winter, G. (1947), "Strength of Thin Steel Compression Flanges," *Transactions of the ASCE*, Vol. 112, p. 547.
- Winter, G. (1958), "Lateral Bracing of Columns and Beams," *Journal of the Structural Division*, ASCE, Vol. 84, No. ST3, March, pp. 1,561-1-1,561-22.
- Winter, G. (1960), "Lateral Bracing of Columns and Beams," *Transactions of the ASCE*, Vol. 125, Part 1, pp. 809-825.
- Winter, G. (1968), *Commentary on the Specification for the Design of Cold-Formed Steel Members*, American Iron and Steel Institute, Washington, DC.
- Winter, G. (1970), *Light Gage Cold-Formed Steel Design Manual: Commentary of the 1968 Edition*, American Iron and Steel Institute, Washington, DC.
- Wong, M.B. (2009), *Plastic Analysis and Design of Steel Structures*, Butterworth-Heinemann, Burlington, MA.
- Xie, M. and Chapman, J.C. (2003), "Design of Web Stiffeners: Axial Forces," *Journal of Constructional Steel Research*, Vol. 59, pp. 1,035-1,056.
- Yuan, H. (1996), "The Resistances of Stud Shear Connectors with Profiled Sheeting," Ph.D. Dissertation, Department of Engineering, The University of Warwick, Coventry, England.
- Yuan, Q., Swanson, J. and Rassati, G.A. (2004), "An Investigation of Hole Making Practices in the Fabrication of Structural Steel," Internal Report, Department of Civil and Environmental Engineering, University of Cincinnati, Cincinnati, OH.

- Yura, J.A. (1971), "The Effective Length of Columns in Unbraced Frames," *Engineering Journal*, AISC, Vol. 8, No. 2, 2nd Quarter, pp. 37-42.
- Yura, J.A., Galambos, T.V. and Ravindra, K. (1978), "The Bending Resistance of Steel Beams," *Journal of the Structural Division*, ASCE, Vol. 104, No. ST9, pp. 1,355-1,370.
- Yura, J.A., Birkemoe, P.C. and Ricles, J.M. (1982), "Beam Web Shear Connections: An Experimental Study," *Journal of the Structural Division*, ASCE, Vol. 108, No. ST2, February, pp. 311-326.
- Yura, J.A. (1995), "Bracing for Stability—State-of-the-Art," *Proceedings of the ASCE Structures Congress XIII*, Boston, MA, April 2-5, 1995, American Society of Civil Engineers, New York, NY, pp. 88-103.
- Yura, J.A., Kanchanalai, T. and Chotichanathawong, S. (1996), "Verification of Steel Beam-Column Design Based on the AISC-LRFD Method," *Proceedings—5th International Colloquium on the Stability of Metal Structures*, SSRC, Bethlehem, PA, pp. 21-30.
- Yura, J.A. (2001), "Fundamentals of Beam Bracing," *Engineering Journal*, AISC, Vol. 38, No.1, 1st Quarter, pp. 11-26.
- Yura, J.A. and Helwig, T.A. (2009), "Bracing for Stability," Short Course Notes, Structural Stability Research Council, North American Steel Construction Conference, Phoenix, AZ, April.
- Zahn, C.J. and Haaijer, G. (1987), "Effect of Connector Spacing on Double Angle Compressive Strength," Materials and Member Behavior, *Proceedings*, Structures Congress 1987, ASCE, Orlando, FL, pp. 199-212.
- Zandonini, R. (1985), "Stability of Compact Built-Up Struts: Experimental Investigation and Numerical Simulation," *Costruzioni Metalliche*, No. 4.
- Ziemian, R.D., McGuire, W. and Deierlein, G. (1992), "Inelastic Limit States Design, Part I: Planar Frame Studies, and Part II: Three-Dimensional Frame Study," *Journal of Structural Engineering*, ASCE, Vol. 118, No. 9, pp. 2532-2567.
- Ziemian, R.D. and Miller, A.R. (1997), "Inelastic Analysis and Design: Frames With Members in Minor-Axis Bending," *Journal of Structural Engineering*, ASCE, Vol. 123, No. 2, pp. 151-157.
- Ziemian, R.D. and McGuire, W. (2002), "Modified Tangent Modulus Approach, a Contribution to Plastic Hinge Analysis," *Journal of Structural Engineering*, ASCE, Vol. 128, No. 10, October, pp. 1301-1307.
- Ziemian, R.D., McGuire, W. and Seo, D.W. (2008), "On the Inelastic Strength of Beam-Columns under Biaxial Bending," *Proceedings—Annual Stability Conference*, Structural Stability Research Council, Nashville, TN.
- Ziemian, R.D. (ed.) (2010), *Guide to Stability Design Criteria for Metal Structures*, 6th Ed., John Wiley & Sons, Inc., Hoboken, NJ.

Metric Conversion Factors for Common Steel Design Units Used in the AISC Specification

Unit	Multiply	by	to obtain
length	inch (in.)	25.4	millimeters (mm)
length	foot (ft)	0.304 8	meters (m)
mass	pound-mass (lbm)	0.453 6	kilogram (kg)
stress	ksi	6.895	megapascals (MPa), N/mm ²
moment	kip-in	113 000	N-mm
energy	ft-lbf	1.356	joule (J)
force	kip (1 000 lbf)	4 448	newton (N)
force	psf	47.88	pascal (Pa), N/m ²
force	plf	14.59	N/m
temperature	To convert °F to °C: $t_c^\circ = (t_f^\circ - 32)/1.8$		

force in lbf or N = mass × *g*
 where *g*, acceleration due to gravity = 32.2 ft/sec² = 9.81 m/sec²